

# ACCELERATOR

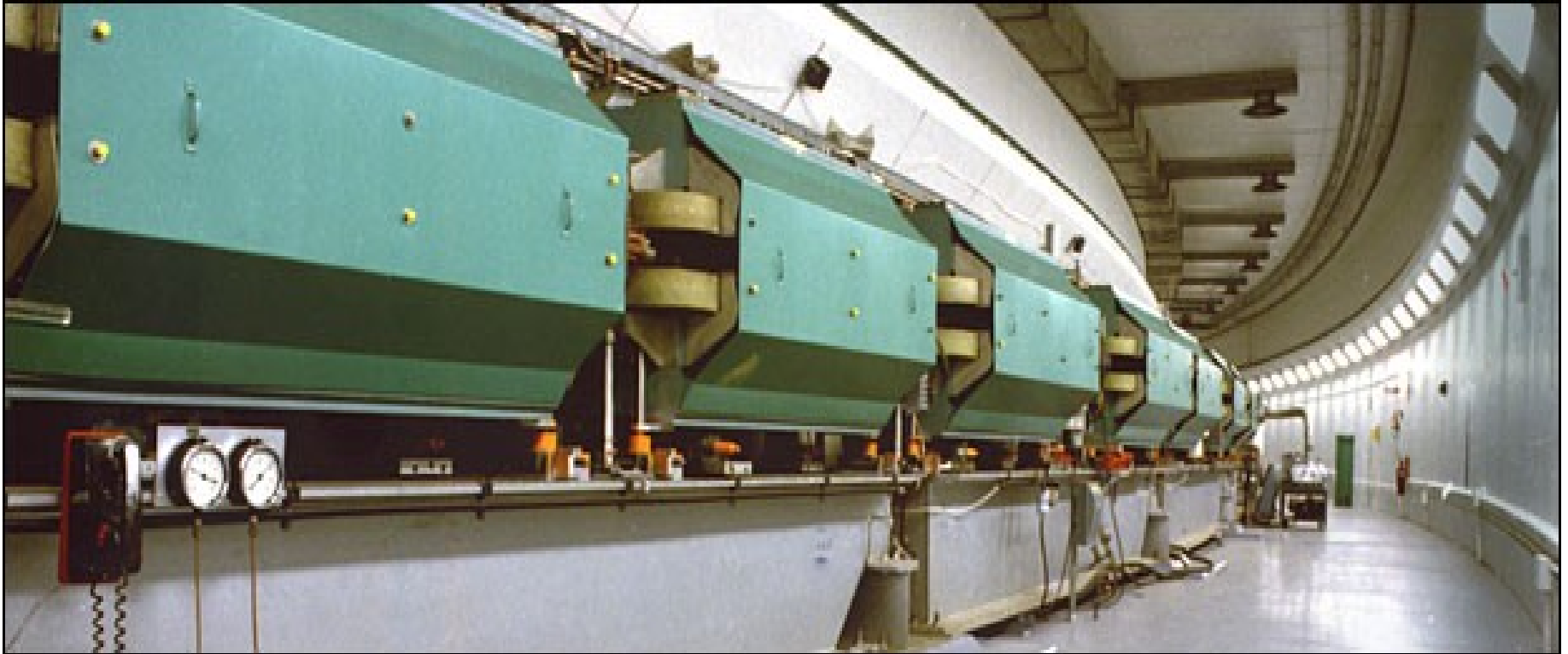

*SBU Physics 2024 PHY691*

- **Charged particle accelerators are engines of discovery in a number of areas of science: life sciences, matter, energy**
- **Depending on the area, they are known as “*atom smasher*”, “*light source*”, “*spallation neutron source*”, “*neutrino factory*”, “*collider*”, “*hadrontherapy ring*” and else**
- **It has taken close to a century – since the emergence of the first founding concepts – for accelerators to reach their nowadays super high-tech level and the important place they now occupy in research and industry**

# This “tour of the accelerator planet” is organized in the following way:

- Some of the main accelerator classes are introduced following their historical chronology (as a concept or as a real, operational apparatus), which includes
  - *(electrostatic accelerators / early XXth century)*
  - *(betatron / 1923)*
  - *linear accelerator - resonant acceleration / 1924-1928*
  - *classical cyclotron / 1929, AVF cyclotron / 1938*
  - *(microtron / 1944)*
  - *(synchro-cyclotron - phase stability / 1945)*
  - *synchrotron / 1945, strong focusing / 1950*
  - *(future: wake-field acceleration, ... / ?)*
- We explore these accelerator techniques with
  - first, a state-of-the-art, essentially some present top-notch accelerator installations and their usage,
  - a bit of history/theory follows: origin, how the idea arose,
  - conclude showing where the technology is heading toward

**We'll keep in mind, in addition, since it gives an understanding of the evolutions, and of preferred technologies depending on the application:**

**accelerators are “particle factories”**

- **They are fabricated for producing intense beams of particles:**

***ions of all sorts, radioactive or not, protons, neutrons, neutrinos, photons of all energies from infra-red to gamma, etc.,***

- **For a number of applications :**

**search for missing mass, supersymmetries, QCD theory, cosmology, cancer treatment, X-lasers, radioscopy, industrial ion implantation, security, and on and on**



# Let's first take a look at basic optical elements that accelerators are made of

- **Vacuum pipe / pumping systems:** beam do not survive long to gas scattering
- **Optical elements:**
  - **Guiding**, along beam lines or around ring: *magnets, electrostatic deflectors*
  - **Focusing**, to maintain beam confined in the vicinity of optical axis: *quadrupoles*
- **Accelerating systems:** *radio-frequency cavities*
- **Beam instrumentation**, for control and monitoring
  - Position: *Beam Position Monitors - BPM*
  - Energy: *radius vs. RF frequency*
  - intensity
  - particle bunch size (beams are actually bunch trains): *beam profile monitors*
  - beam collimation
- **A lot of IT**, for all of the above. ML and AI developments blooming
- **Case of specialized beams:**
  - polarized beams: special magnets to manipulate spin, specific command/control instrumentation
  - High power: manage power loss along beam lines
  - Beams for medical application
  - Etc.

Bending magnets.  
They ensure beam steering

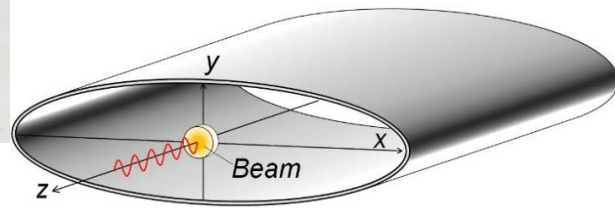
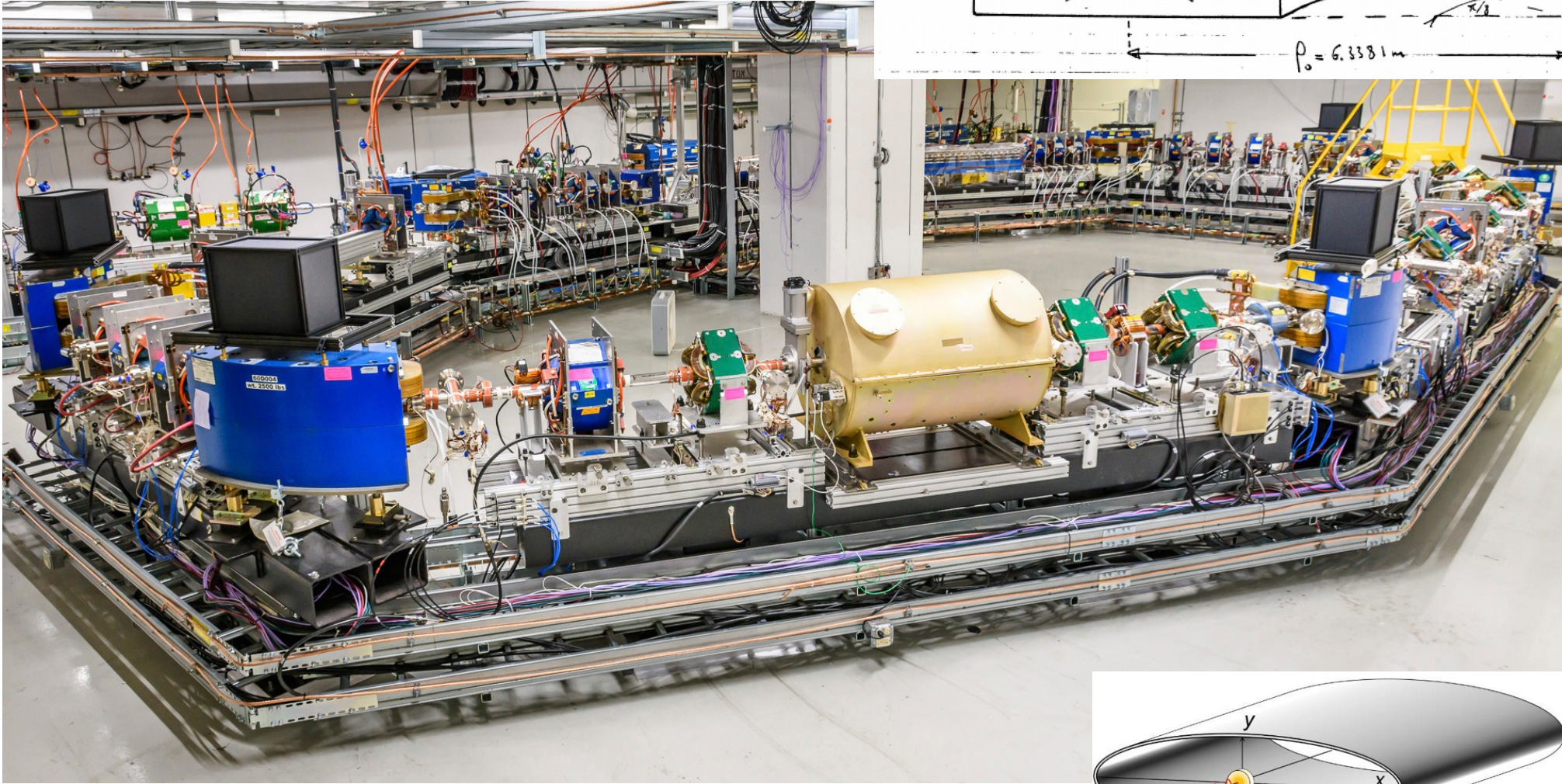
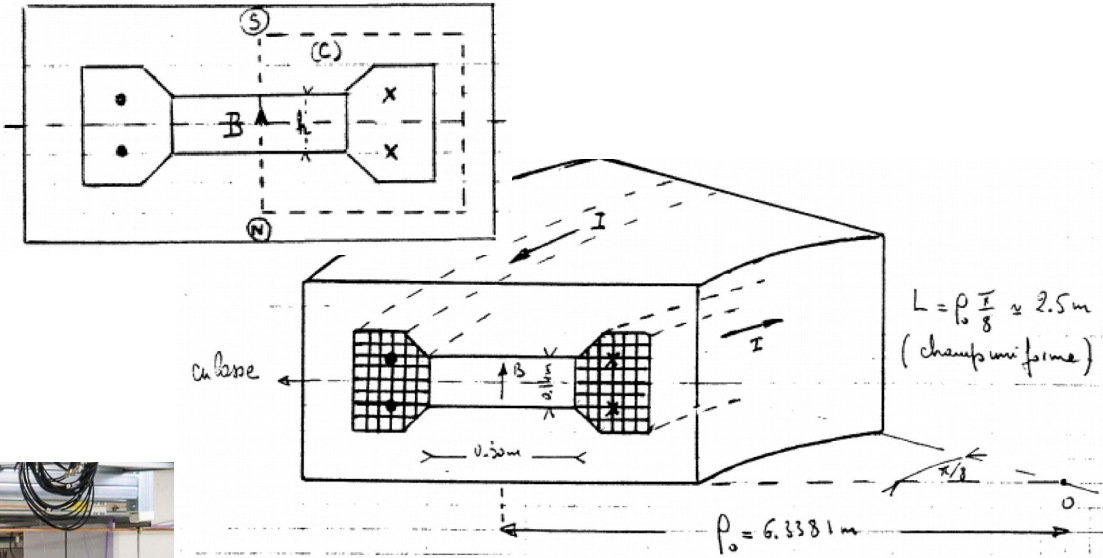

Fermilab's "Integrable Optics" Test Accelerator



# Quadrupoles ensure focusing. Drift spaces complete the optical landscape

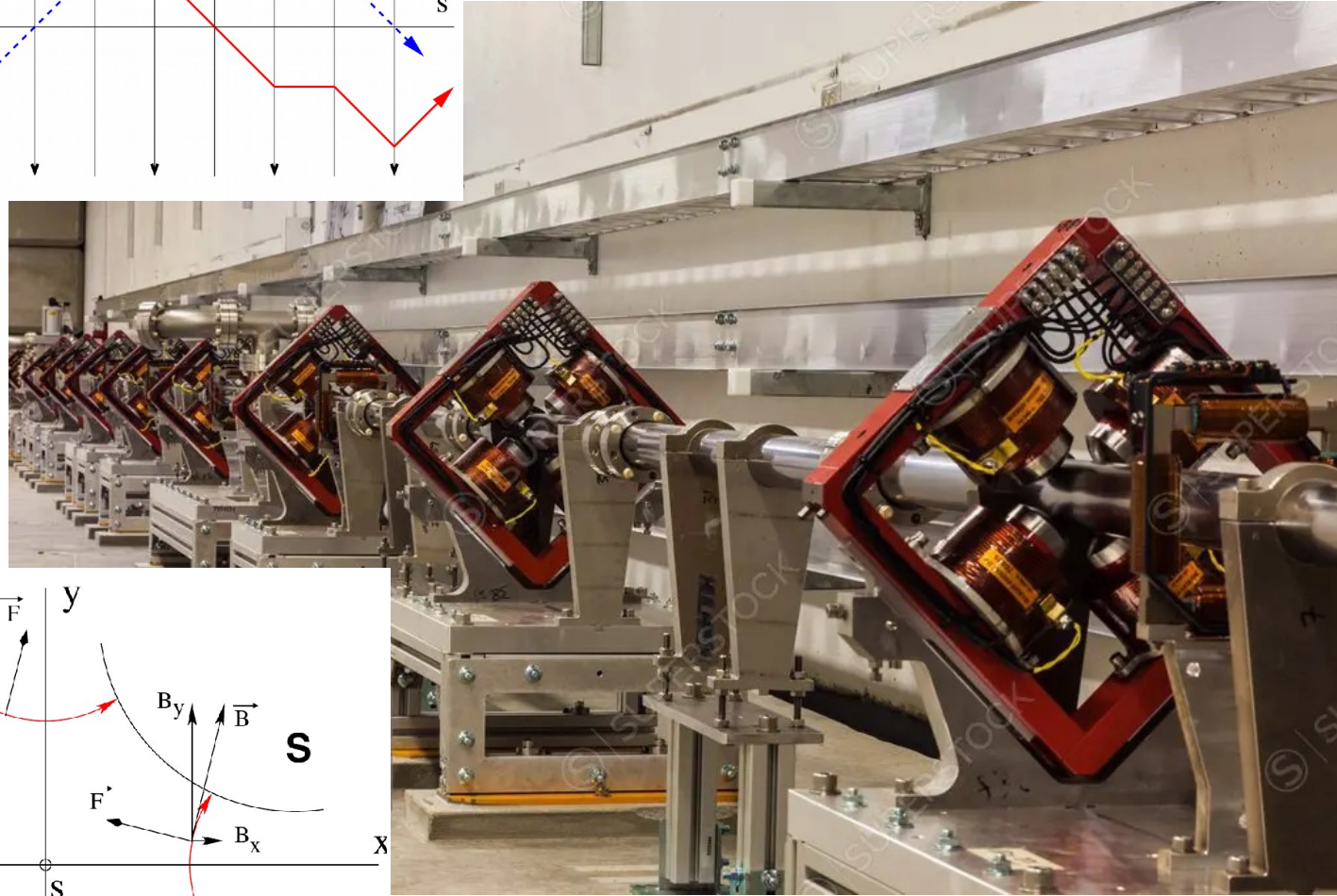
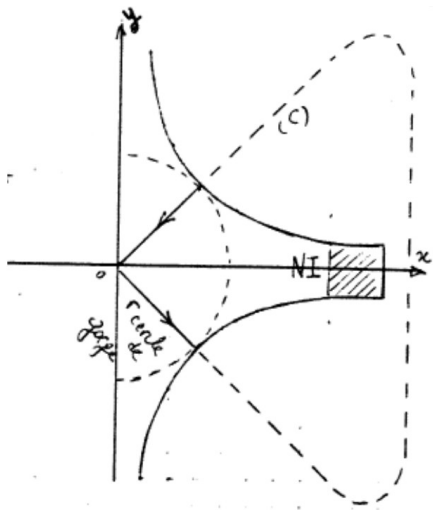
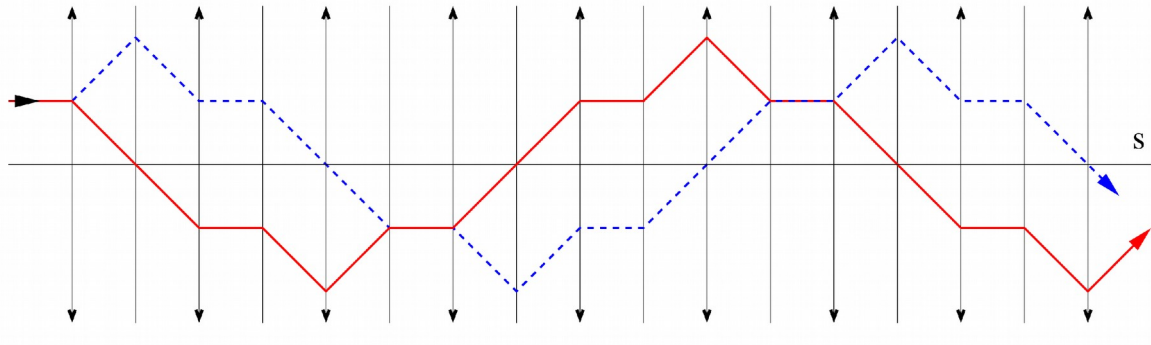

Poles are hyperbolic equipotentials:  
 $V = axy$

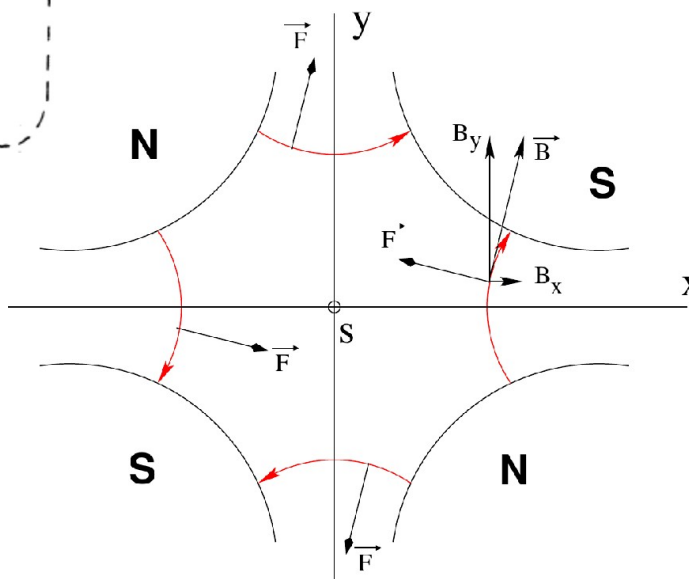

Thus,  
 $B_x = ay, B_y = ax$

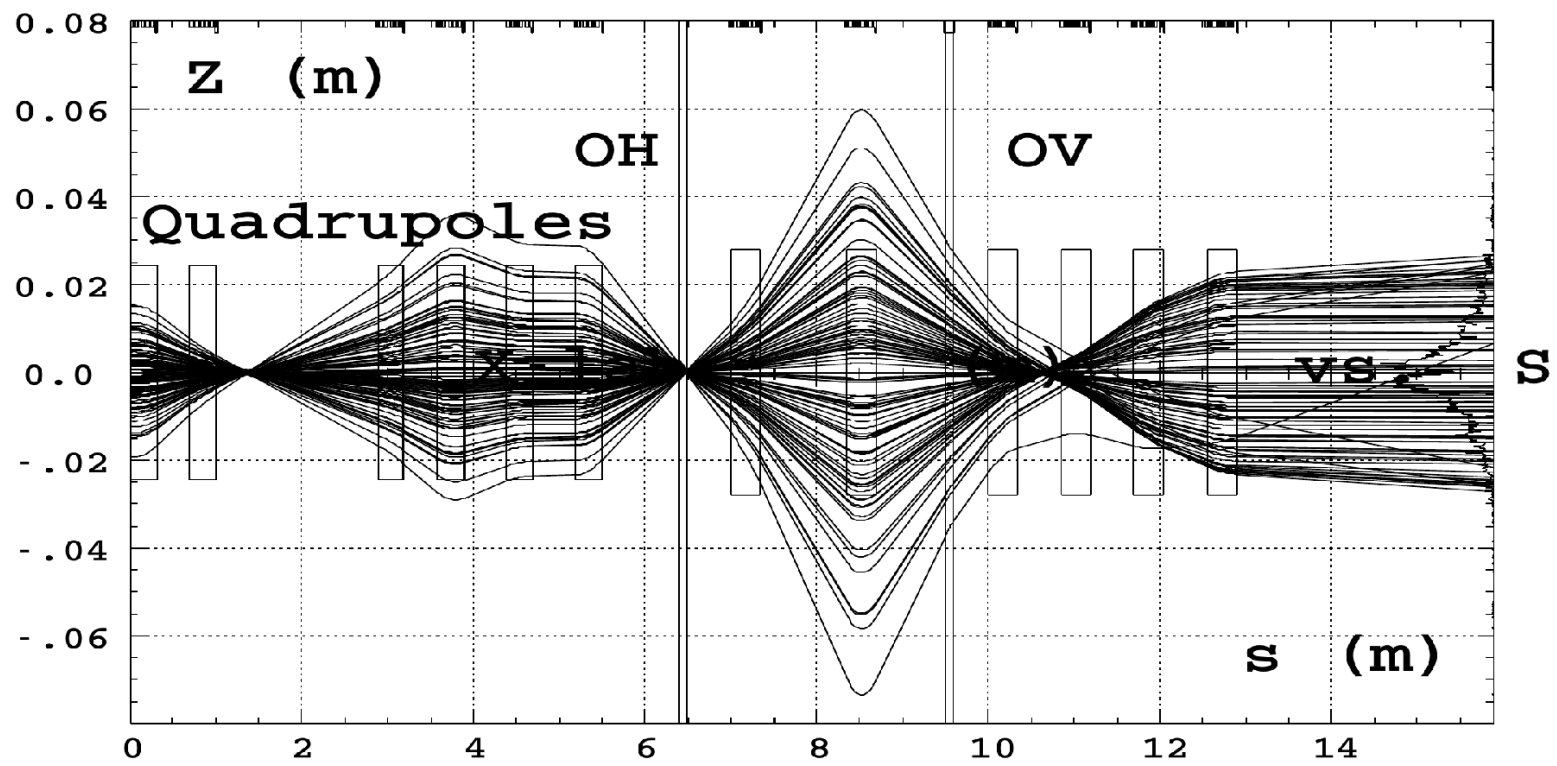
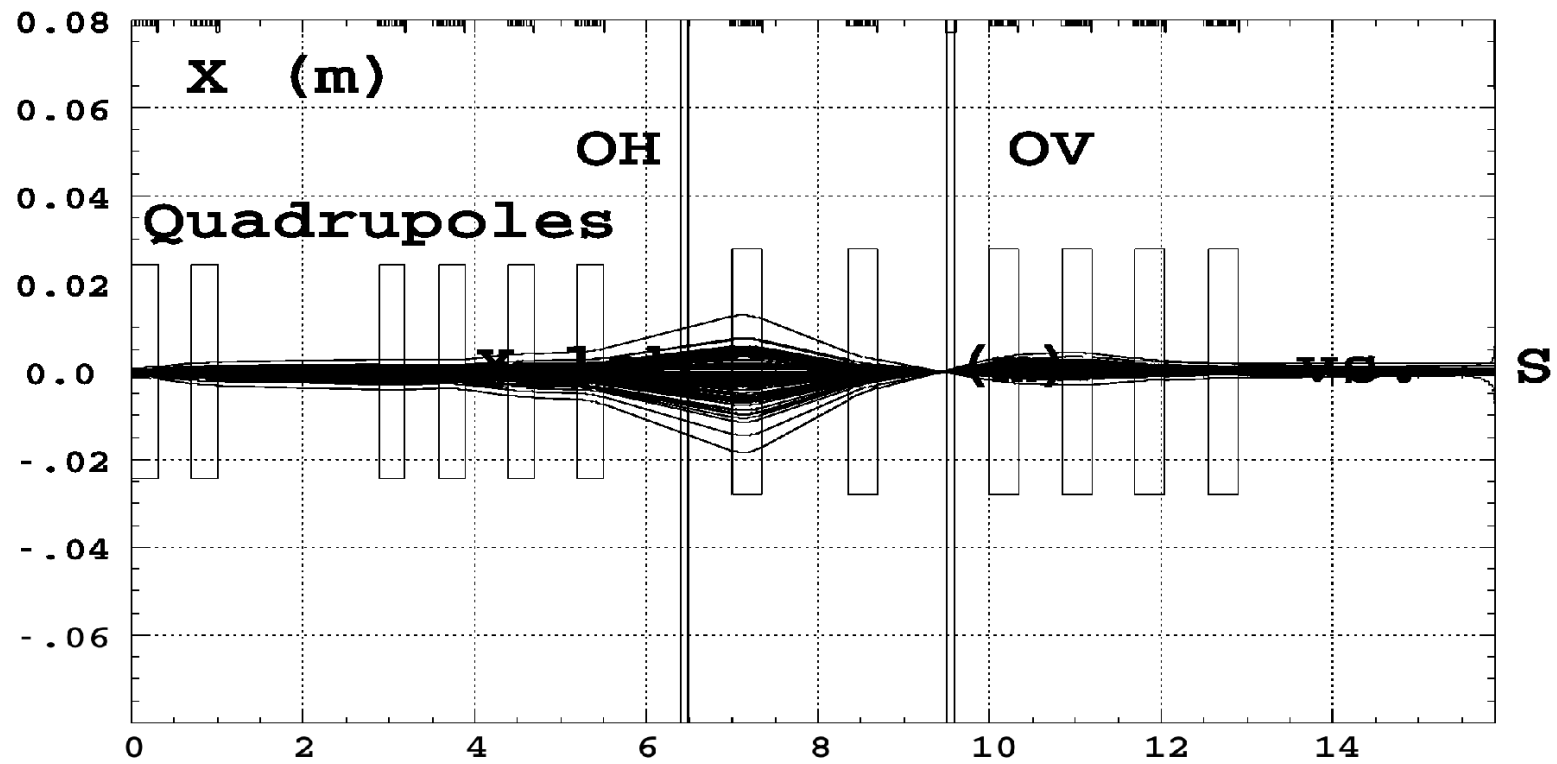

# Accelerating systems

Principle:

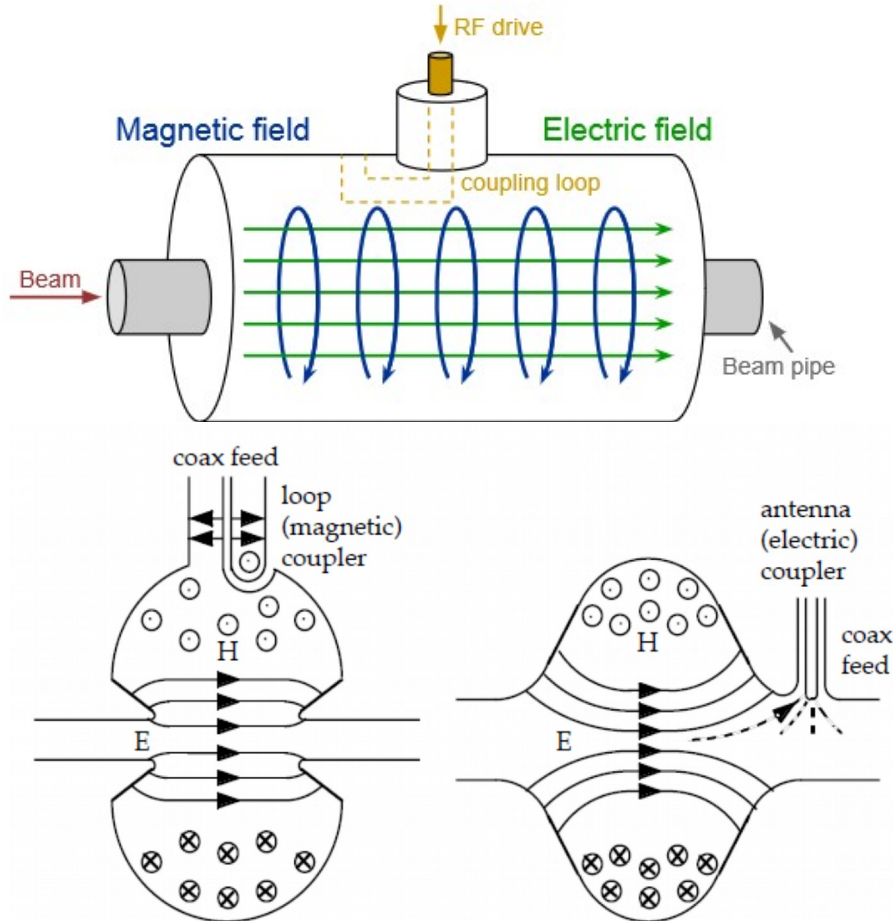

The box wall is conducting:  
Currents circulate at the surface

LHC RF cavity string - 7 TeV ring



RF cavities of AGS - 25 GeV ring

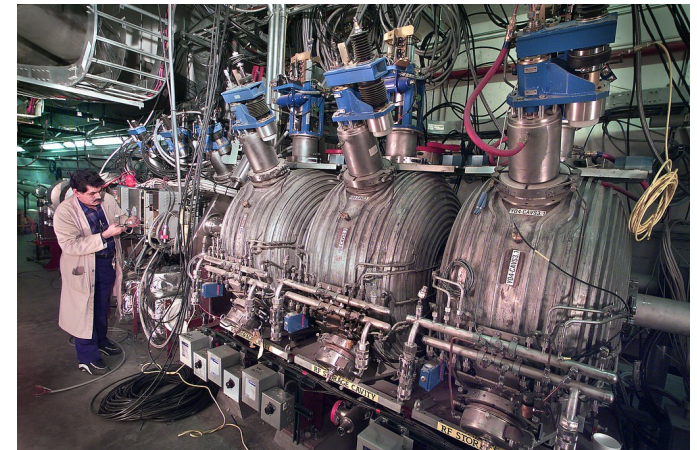

Let's put some numbers:

- Energy boost in a cavity can be few keV in small ring,

thus number of turns is  $100s \text{ MeV}_{\text{[final]}} / \text{few keV}_{\text{[per pass]}} \sim \text{million of turns.}$

- Up to  $\sim \text{MeV}$  in a super-conducting linac, e.g., 0.2 to 1 GeV is a matter of  $\sim 800$  cavities.



*(electrostatic accelerators)*

*(betatron)*

# **LINEAR ACCELERATORS**

*cyclotron*

*(microtron)*

*(synchro-cyclotron)*

*synchrotron*

*(acceleration techniques of the future)*

Here is one:  
SNS 1.2 GeV super-conducting linac  
accelerates H- from 200 MeV to 1 GeV,  
81 RF cavities in 23 cryo-modules

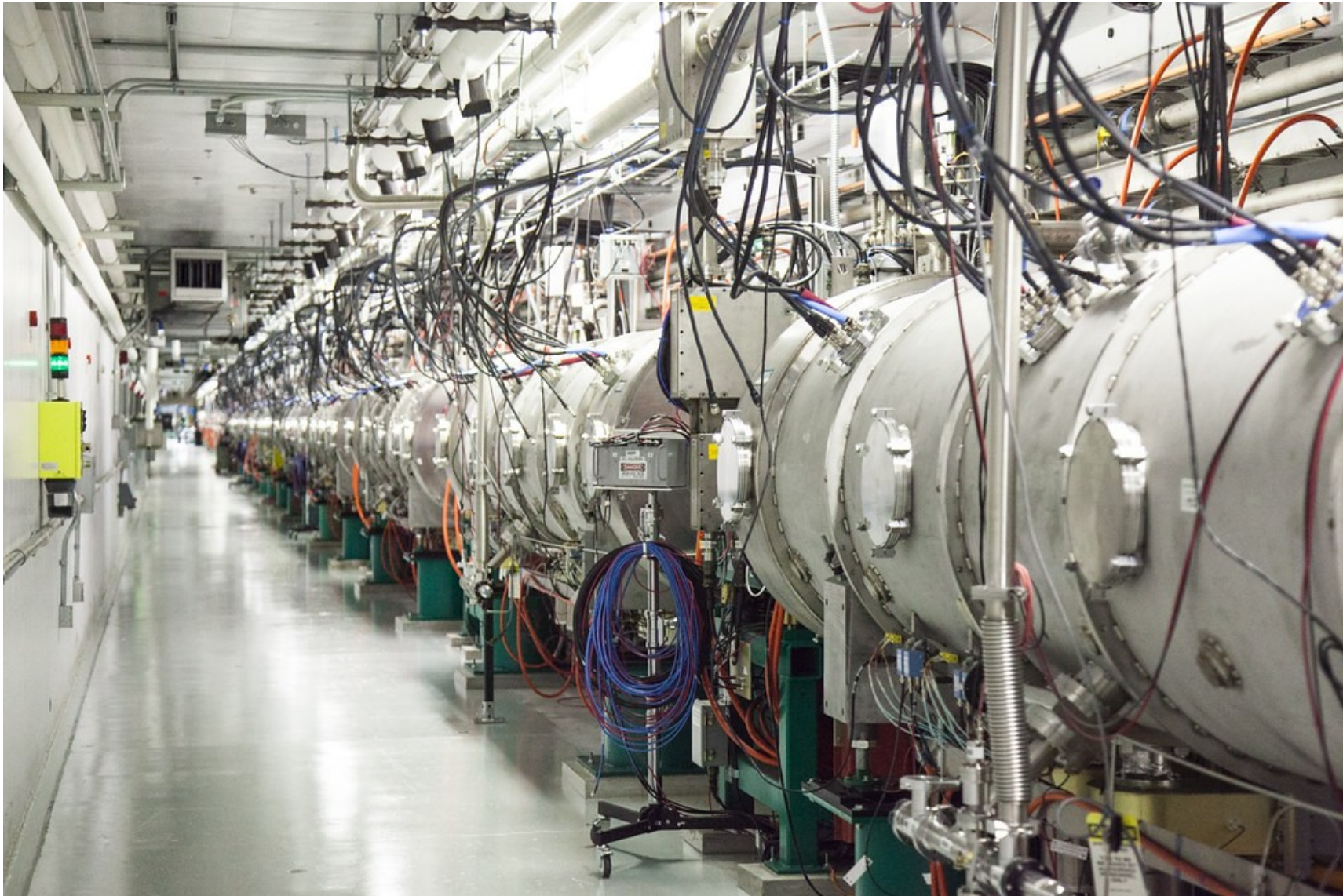

# Application of linacs (ex. 1/2)

*Neutron production by spallation, aimed at replacing neutron reactors*

- Flux, in modern research reactors, typically:  $10^{15}$  /cm<sup>2</sup>/s
- From spallation sources, i.e., accelerators :  $10^{17}$  /cm<sup>2</sup>/s

*A greater flux reduces the time required to conduct an experiment.*

*(We'll see similar leap in diverse other sectors, e.g., high photons flux from "light source" synchrotron versus X-ray tubes)*

- The two technologies, reactor and accelerator, compete today.

*Drawback of the reactor method : requires highly enriched U235, 20%, in some cases "weapon grade" EU, 93% U235 - potential for proliferation. Yet, there are programs to switch to LEU... that's another story !*



**SNS, Oak Ridge National Lab. Operates since 2006.**  
**The largest, highest power, *linear*, proton accelerator in the world.**



SNS is based on a 1 GeV,  
H- linear accelerator

**A gain of  
1200 MeV in  
kinetic energy,  
over 180 m**

**i.e., an average  
7 MeV/m**

***that's the state-of-  
the-art***

**A 180 m long,  
2K frigidaire**

**SNS linac super-conducting RF cavity**

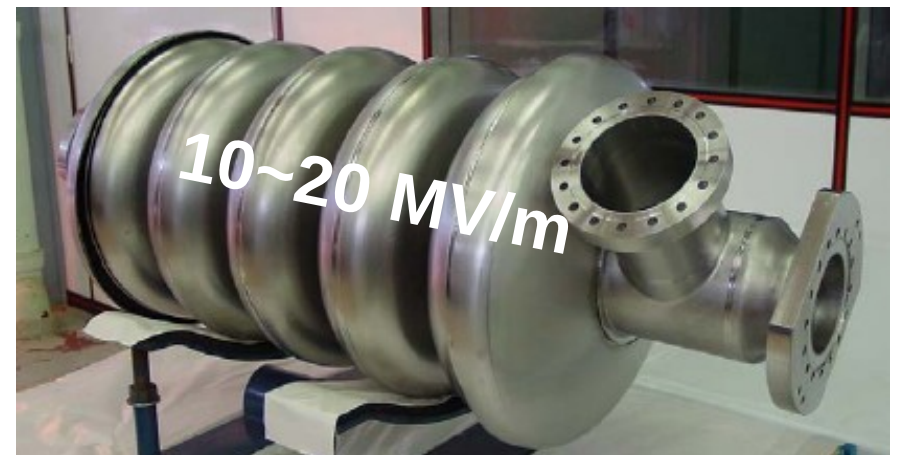



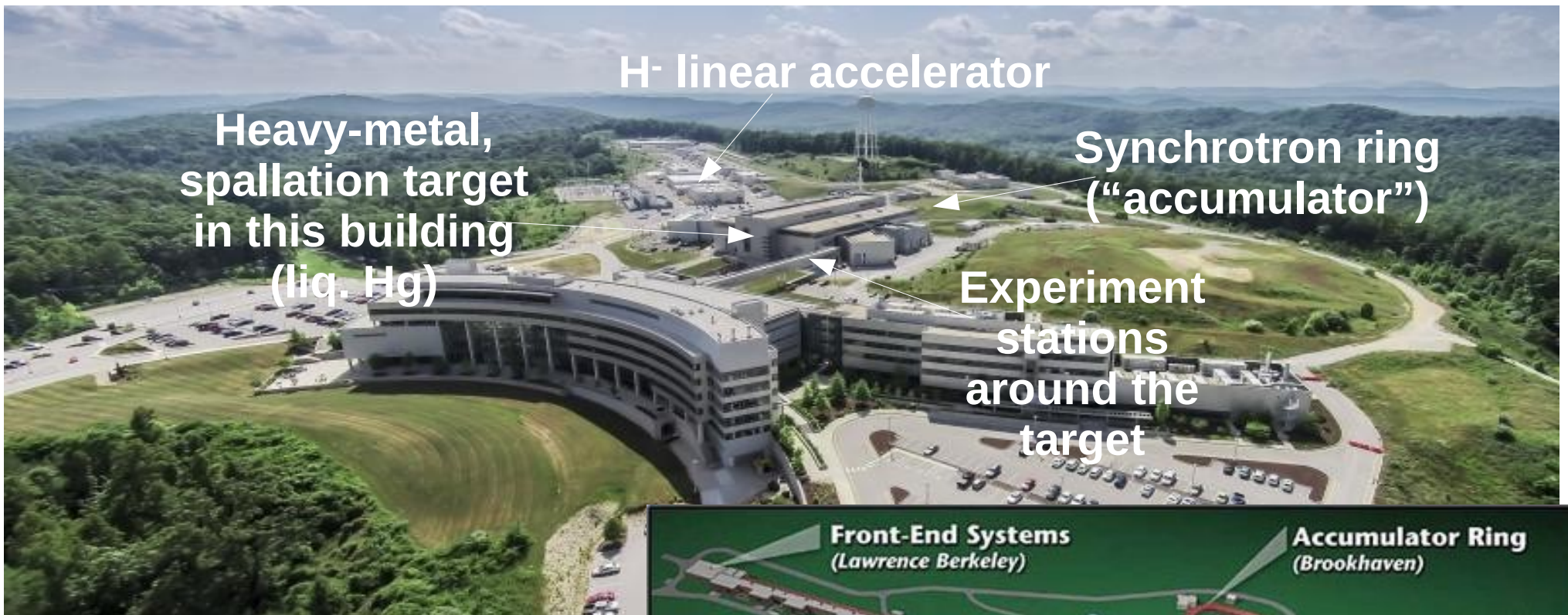

Commissioning		2006	
SCL linac length	m	180	
Kinetic energy	GeV	1	
Beam power	MW	1.4	
Repetition rate	Hz	60	
Duty factor (df)	%	6	
Peak current (I <sub>p</sub> )	mA	23	
Average current	mA	1.4	= I <sub>p</sub> x df ~ 23[mA] x 6[%]

# Application of linacs (ex. 2/2)

## *Free-Electron Lasers*

### FEL

#### Interest :

- laser-like, high energy (e.g., X) photon beams

#### Applications:

- applied research (condensed matter, ...)
- particle beam manipulations (e.g., beam cooling)

# FLASH SASE FEL INSTALLATION, HAMBURG

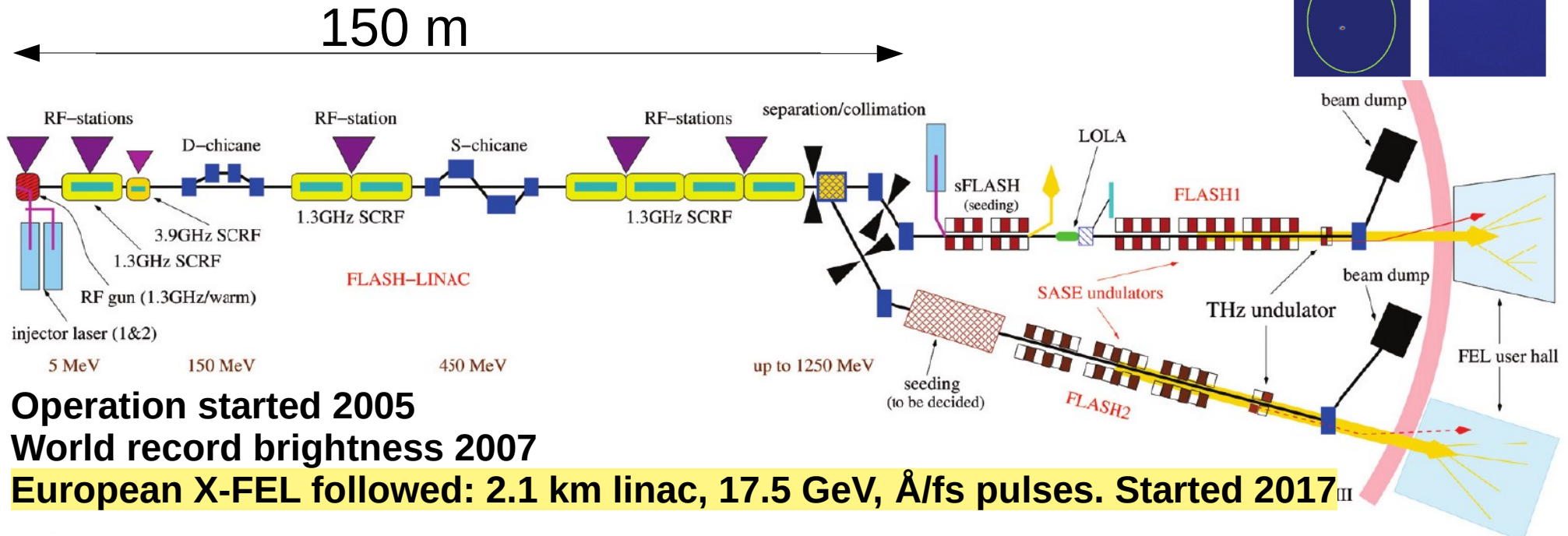

Operation started 2005

World record brightness 2007

European X-FEL followed: 2.1 km linac, 17.5 GeV, Å/fs pulses. Started 2017<sup>III</sup>

$e^-$  :

emittance	$\beta\gamma\epsilon_{x,y}$	
(1 nC, on-crest, 90% rms)		1.4 mm mrad
charge		0.08 - 1.0 nC
peak current		0.8 - 2.0 kA
beam energy		380 - 1250 MeV
bunches / train		1 - 450
bunch spacing		1 - 25 $\mu$ s
train repetition frequency		10 Hz

$\gamma$  (FLASH1):

wavelength (fundamental)	4.2 - 45 nm
average single pulse energy	10 - 540 $\mu$ J
pulse duration (fwhm)	<30 - 200 fs
spectral width (fwhm)	0.7 - 2.0 %
peak power	1 - 3 GW
peak brilliance	$10^{29} - 10^{31}$ (+)
average brilliance	$10^{17} - 10^{21}$ (+)
(+): photons/( s mm <sup>2</sup> mrad <sup>2</sup> 0.1%bw )	



# Undulator radiation

[Motz et als., Stanford, 1953]

~1GeV  
electron  
linac

A long string (meters) of  
~cm scale magnetic periods.  
Wiggles the e-beam over  
a few meters

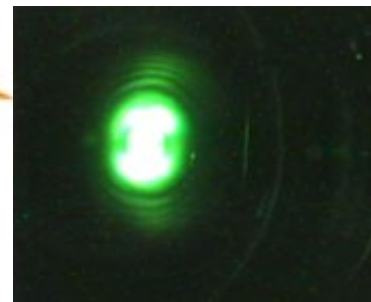
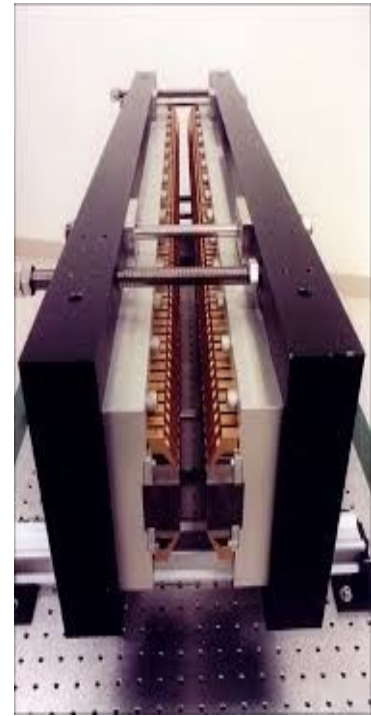

In an FEL, the undulator is embedded in a resonant cavity, just as a laser medium.

[Madey, Stanford, 1976]

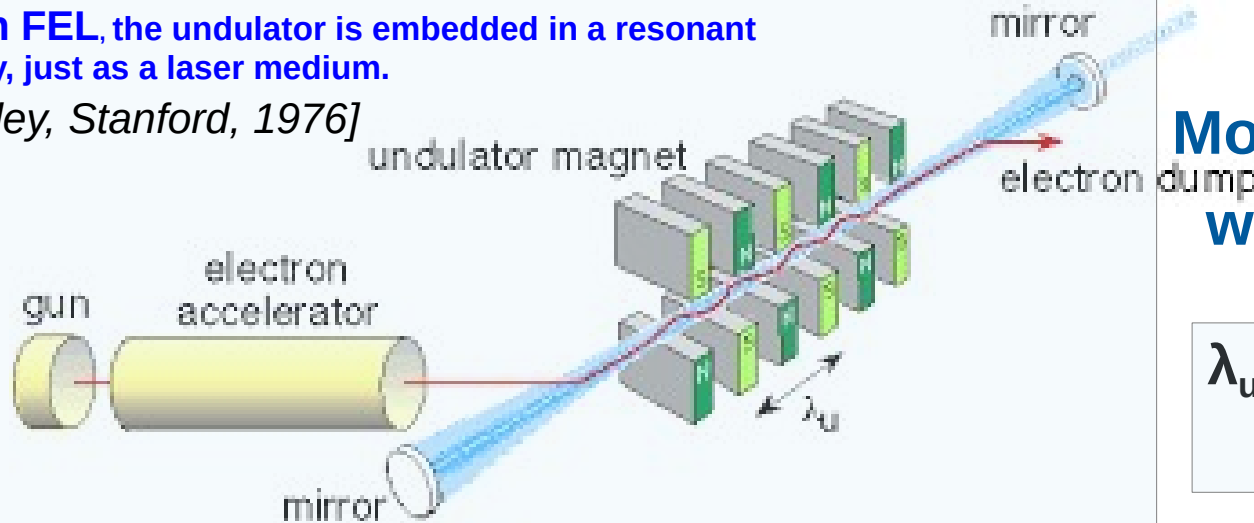

Monochromatic light spot,  
wavelength,  $\lambda \sim \lambda_u / (2\gamma^2)$

$$\lambda_u \sim \text{cm and } \gamma = 2000 \cdot E_{[\text{GeV}]}$$

→  $\lambda \sim \text{nm laser beam}$

# A derivative: SASE-FEL

## Self-Amplified Spontaneous Emission

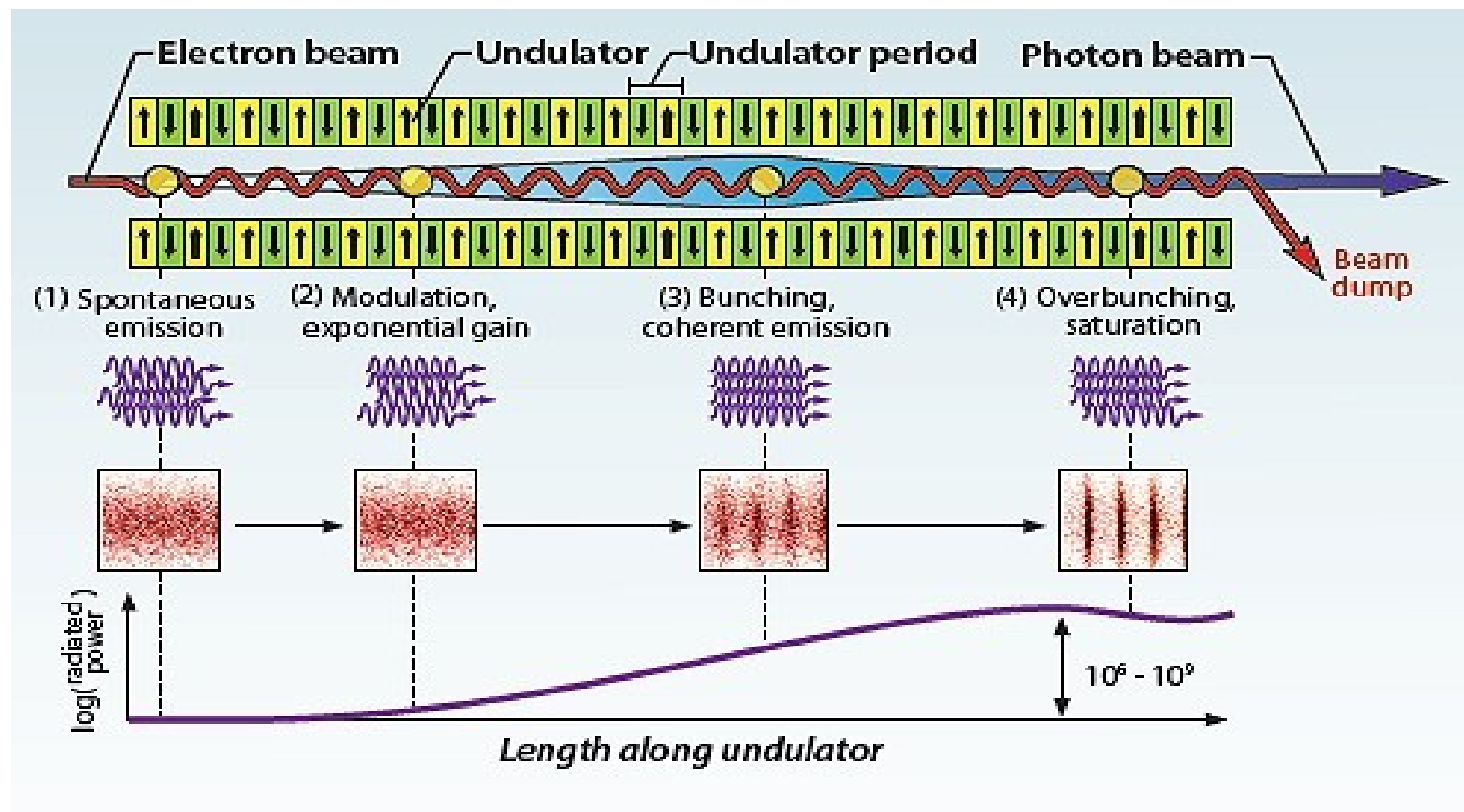

- Principle : the longitudinal density of the  $\sim 10$ s  $\mu\text{m}$  long e-bunch modulates into a set of short sub-bunches, each with length  $\sim \lambda$ .
  - Thus : partial radiation coherence, power from sub-bunch  $\sim (Ne)^2$  rather than (incoherent) power  $\sim N e^2$ , i.e., high brightness highly collimated femtosecond X-ray pulses. Can make life science X-movies !

**Linear accelerators**

**where they come from**

## Ising linac

- 1924, Ising proposes the acceleration using a variable electric field between drift tubes (the father of the Linac).
  - The potential wave is applied to the gaps via wires (a1, a2, a3...) with adjusted lengths to ensure synchronism.
- A consequence: only works if velocity increases with time → non-relativistic regime.
- Between gaps, particle bunchlets travel with constant velocity within drift tubes 1, 2, 3.
  - It appeared not technologically possible to achieve a practical accelerator.
    - difficulty of spark excitation
    - inefficiency of wire transmission lines

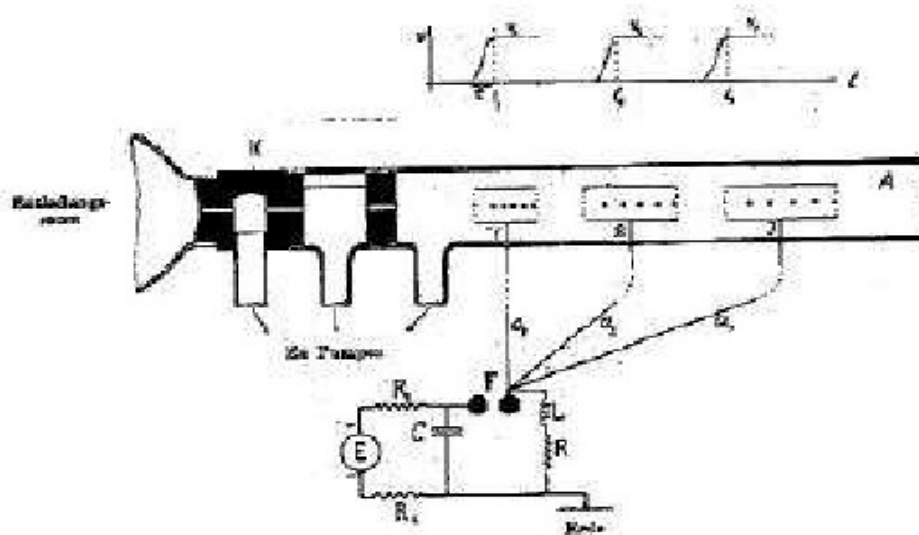





## Alvarez linac (1/2)

- The development of radar technology during WWII offered pulsed, *high power*, up to GHz RF generators (“magnetron”, “klystron”), so allowing wavelengths in meter range (appropriate for ions  $v/c < 1$ ) to cm range (electrons,  $v \approx c$ ).
- 1946, L. Alvarez and coworkers at the Lawrence Berkeley Radiation Laboratory developed a proton linear accelerator based on injection of 200 MHz RF wave into a *resonant* metallic cylindrical cavity containing the wideroe-type drift tube arrangement.
  - the linac is injected with a 4 MeV electrostatic accelerator
  - protons are accelerated up to 32 MeV in the Alvarez structure

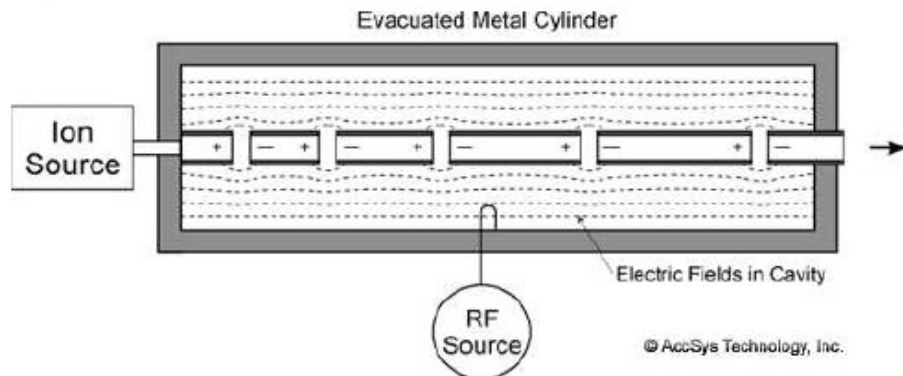

**1968**

Contribution in elementary particle physics

*Remember, Wideroe's tubes were in a glass cylinder (strong antenna-like power losses), they were connected to an AC generator.*

- Transverse focusing : ensured at gaps by grids shaping the (varying) E field.
- RF phasing : an accelerating standing wave fills the cavity. The particular resonant mode of interest (amongst oodles) is that with all gaps having the same polarity (“ $\beta\lambda$ ” or “ $2\pi$ ” accelerating mode)
- Evolutionary geometry of the tubes (length & diameter) with distance causes cells to resonate on identical frequency.



## Alvarez linac (2/2)

- Later on longitudinal focusing (phase stability) would be invented, ensuring best transmission. Transverse focusing today ensured with quadrupoles located in the drift tubes.
- DTLs are nowadays currently used as primary injection stages in hadron linac chains, or as injectors into synchrotrons.



202M Hz/70 MeV Alvarez injector linac at ISIS, RAL.

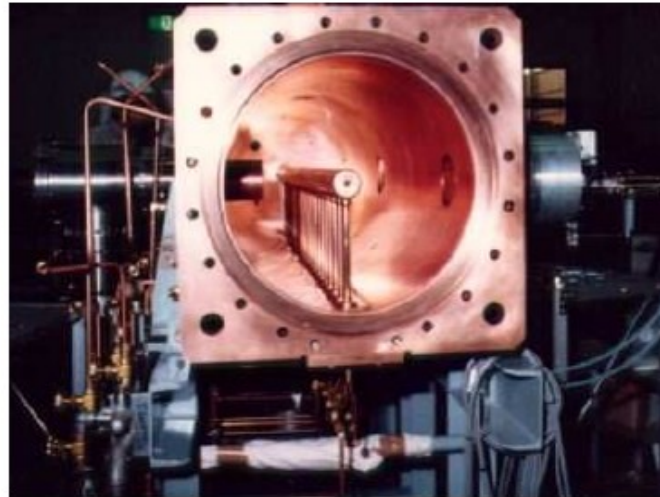

7 MeV Alvarez DTL, typical injector of medical synchrotron : pre-acceleration of protons or Carbons before injection into synchrotron.

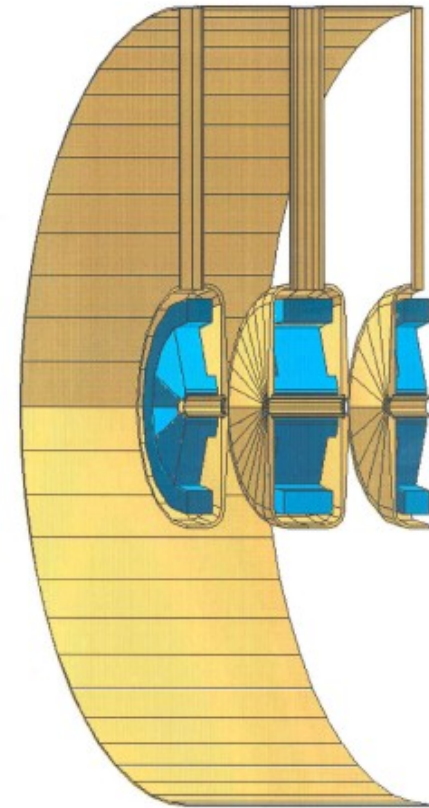

Quadrupoles in drift tubes.

**Going where, nowadays ?**

# \* More sns: ESS, the EU spallation source \*

Construction started 2014; first users 2023

Linac length, overall	m	~400	
Kinetic energy	GeV	2	proton
Beam power	MW	5	
Repetition rate	Hz	14	
Duty factor (Df)	%	4	
Pulse current (I <sub>p</sub> )	mA	62.5	
Average current	mA	2.5	
Pulse length at target	ms	2.86	

**ESS,  
Lund,  
Sweden  
Jan 2019**

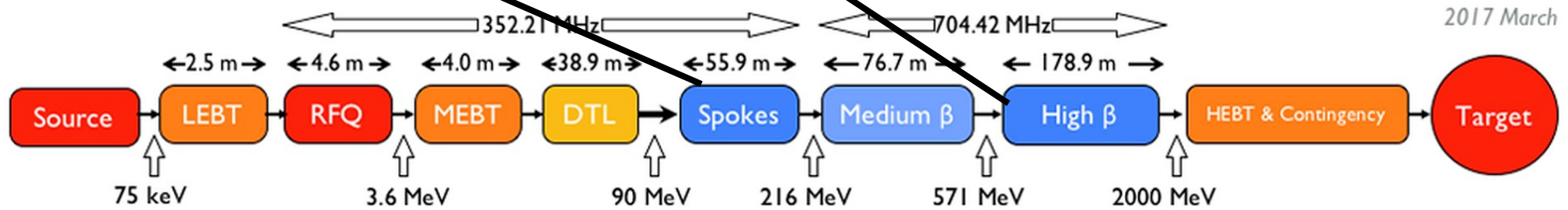
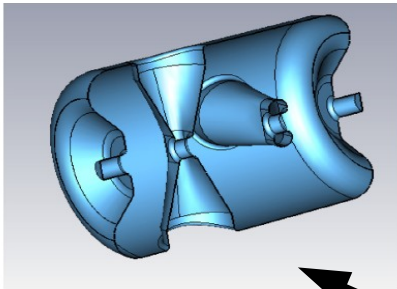
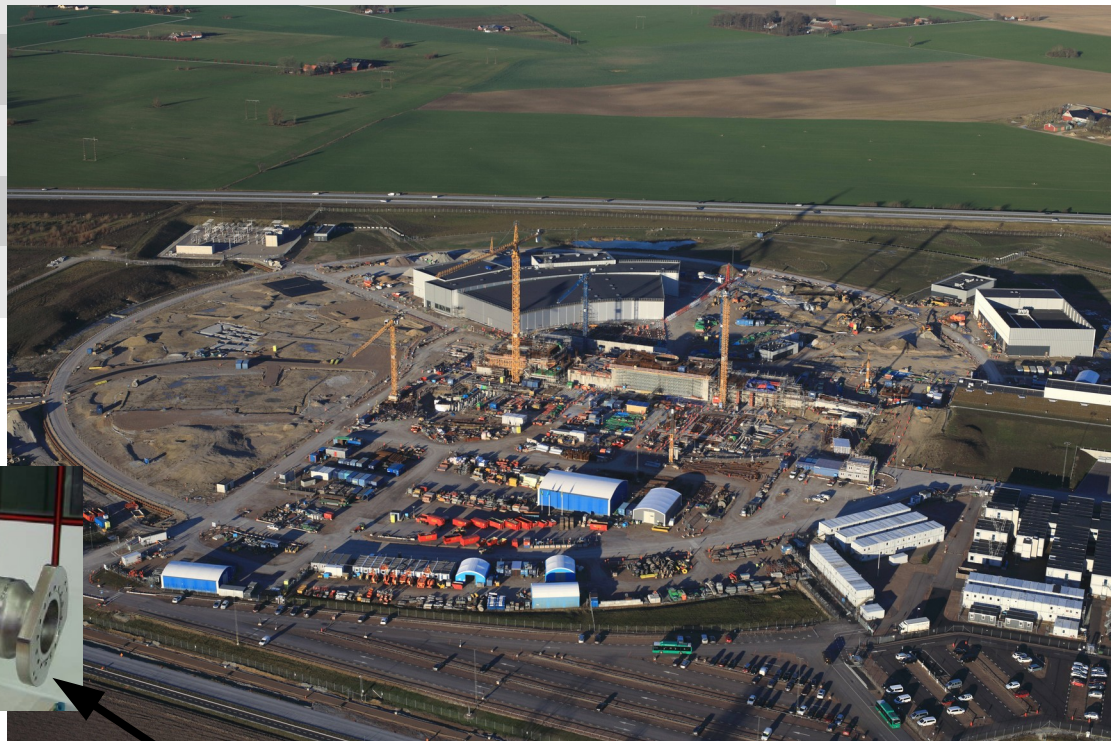



# \* Intense beams of rare isotopes - FRIB \*

A new scientific accelerator facility for nuclear science, in East Lansing, funded by the U.S. DOE, Michigan State University, and the State of Michigan.

Construction started 2014

Completion 2022

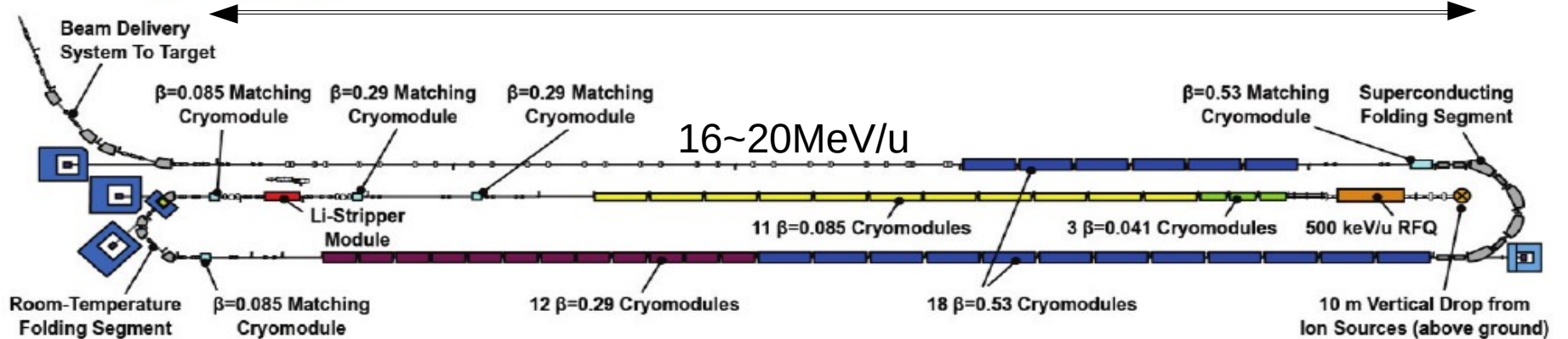
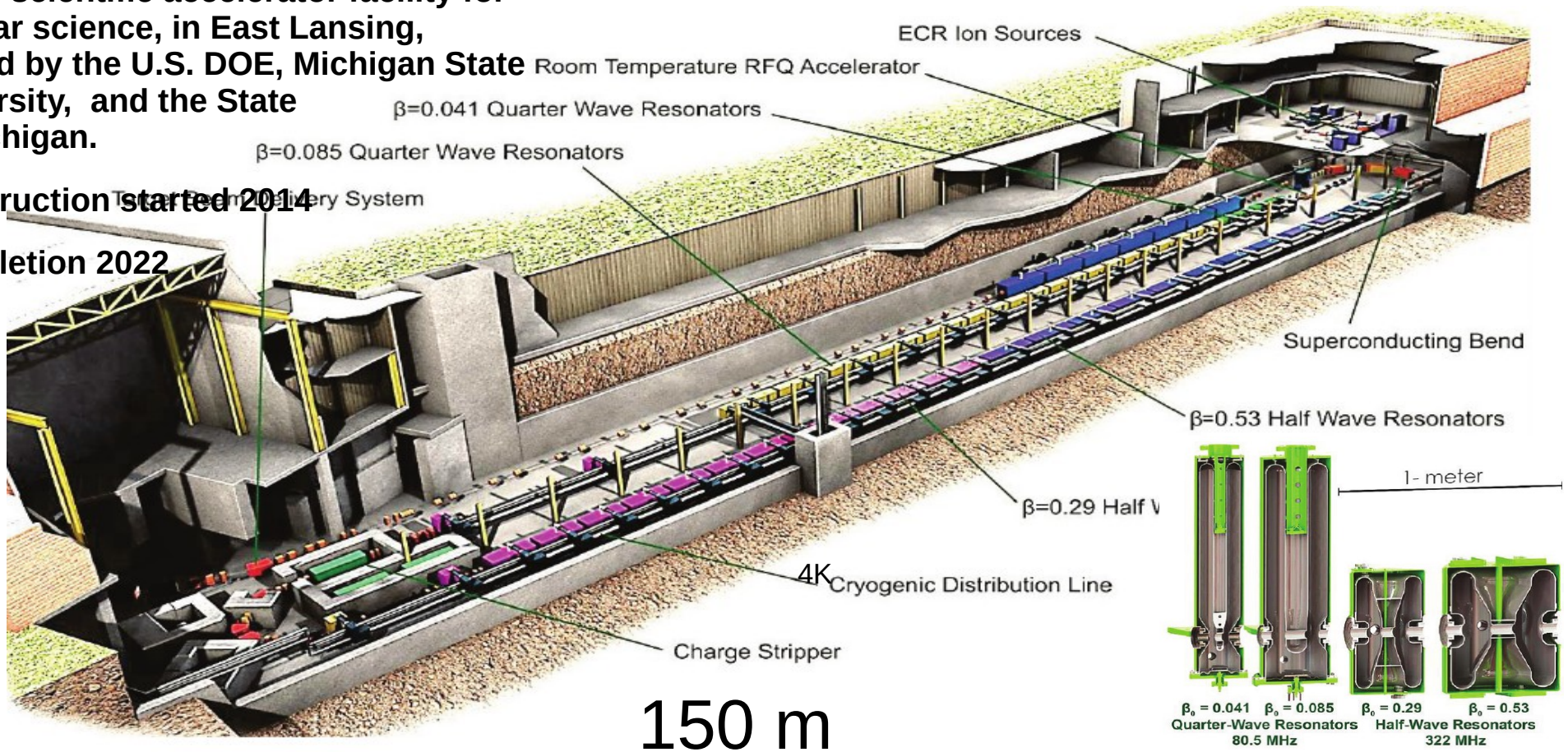

# \* ENERGY \*

## ACCELERATOR-DRIVEN SUBCRITICAL REACTOR

### Accelerator

(600 MeV - 4 mA proton)

### Reactor

- Subcritical or Critical modes
- 65 to 100 MWth

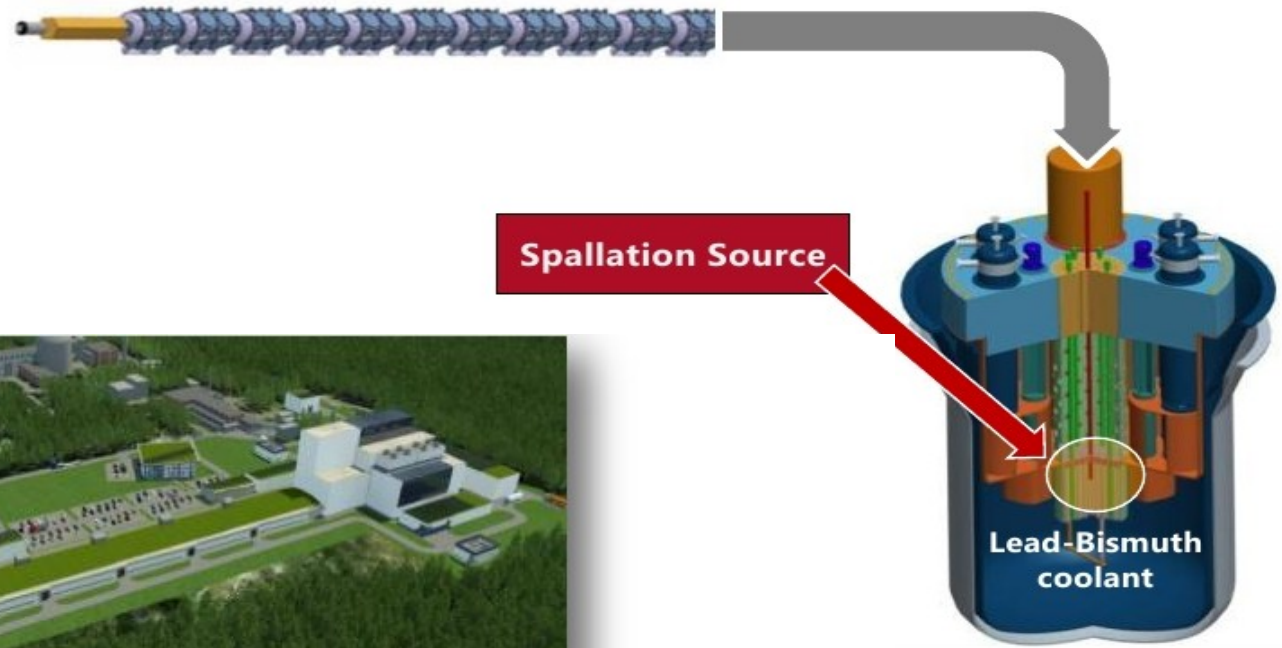

## MYRRHA, Belgium

**M**ultipurpose **hY**brid **R**esearch **R**eactor for **H**igh-tech **A**pplications  
**A flexible and fast spectrum irradiation facility**



- **Required beam power  $P_B$ , for  $P_{th}$  reactor power :**  
**With beam energy  $E_B \approx 1$  GeV, a handy estimate is**

$$P_B \approx \frac{1}{2}(1 - k_{eff}) P_{th}$$

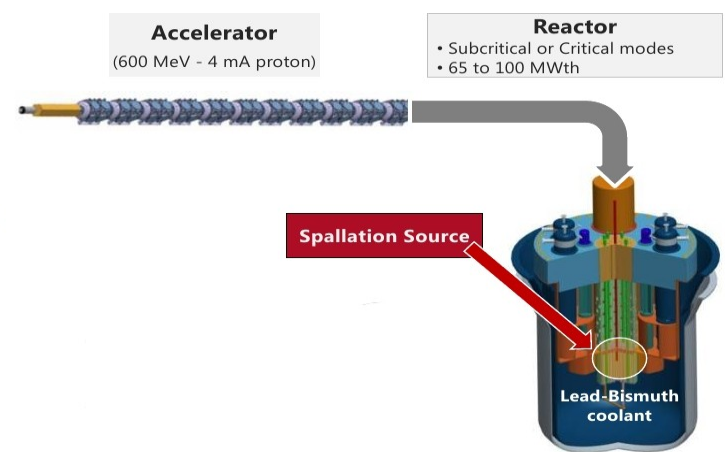

$$P_B = E_B \frac{P_{th} (1 - k_{eff})}{f E_f k_{eff}} \left\{ \begin{array}{l} k_{eff} = \text{neutron multiplication factor} = \frac{n \text{ produced}}{n \text{ absorbed}} \approx 0.95 - 1^- \\ E_f = \text{fission energy} \approx 200 \text{ MeV} \\ f = \text{fraction of neutrons causing fission} \approx \frac{1 \text{ GeV-p } 20 \text{ n/incident p}}{2.5 \text{ n/fission}} \end{array} \right.$$

- $k_{eff}$  is central to the accelerator parameters, the closer it is to 1, the lower the beam power to be brought in - but, drawback, the closer the reactor core to critical.

- Typical numbers -			
	ADS thermal power	$k_{eff}$	Proton beam Energy / Current / Power
<b>Demo transmuter MYRRHA:</b>	<b>50-100 MW-th</b>	$\approx 0.95$	<b>600 MeV / 4 mA / 2.4 MW</b>
<b>EFIT industrial transmuter:</b>	<b>several 100 MW-th</b>	$\approx 0.97$	<b>800 MeV / 20 mA / 16 MW</b>
<b>China's demonstrator program:</b>	<b>1000 MW-th</b>		<b>1.5 GeV / 10 mA / 15 MW</b>





*(electrostatic accelerators)*

*(betatron)*

*linear accelerators*

# **CYCLOTRONS**

*(microtron)*

*(synchro-cyclotron)*

*synchrotron*

*(acceleration techniques of the future)*

# High power, PSI, 600 MeV, 1.4 MW, CW

1973

- 1 Hans Willax
- 2 Miguel Olivo
- 3 Thomas Stammbach
- 4 Werner Joho
- 5 Christa Markovits





# 1966: SIN early Design – Feb. 1974:1st 100 $\mu\text{A}$ beam

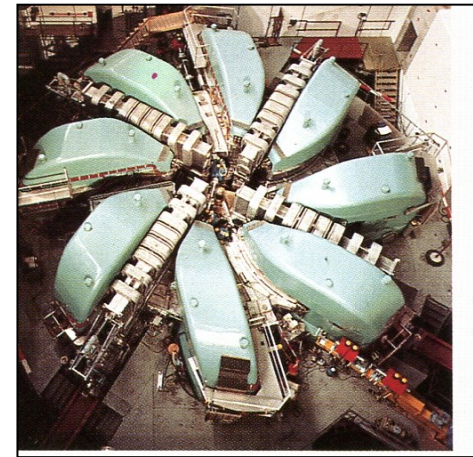
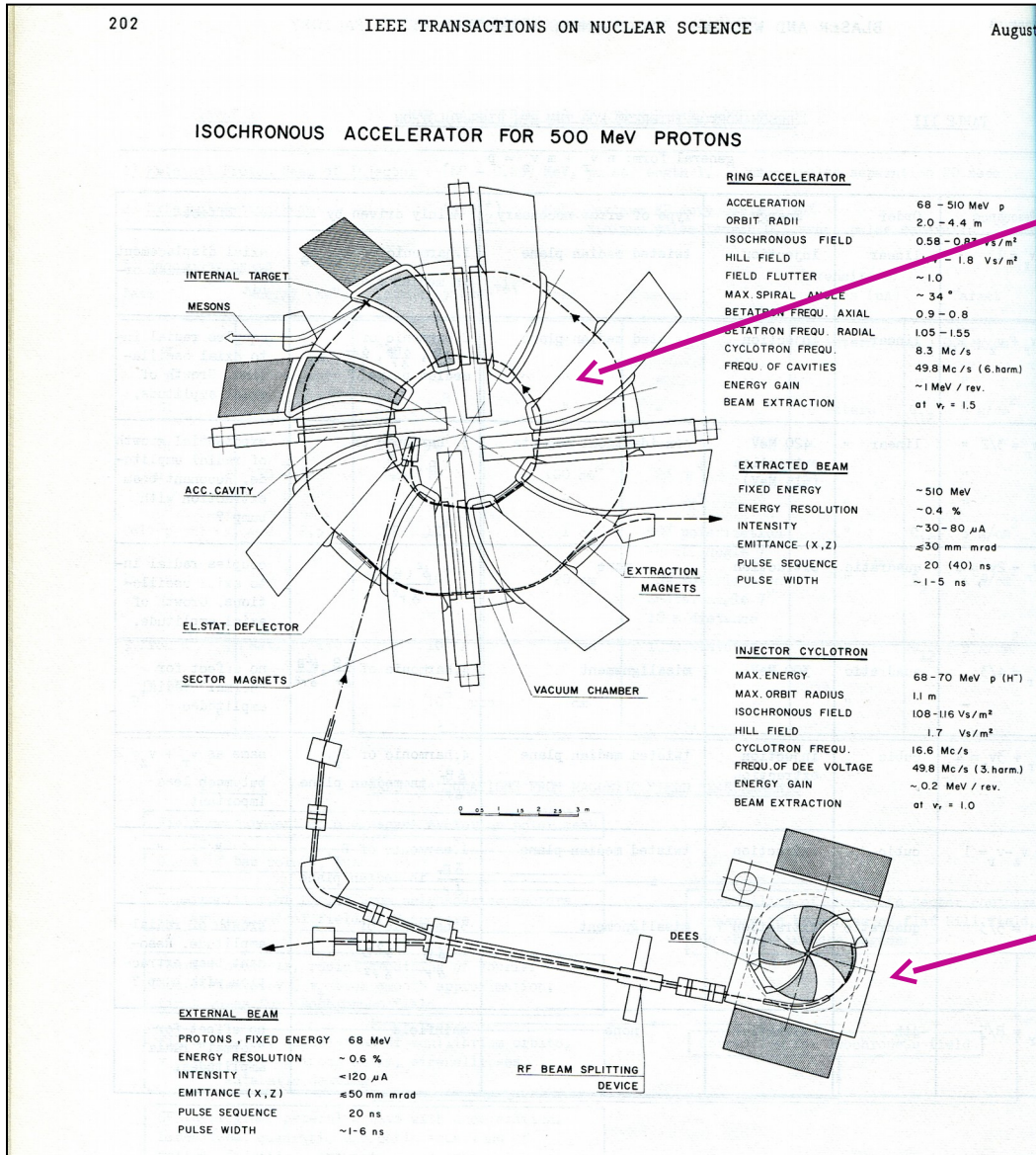

The 590 MeV Ring Cyclotron

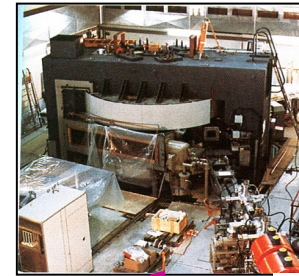

The old 72 MeV Philips injector

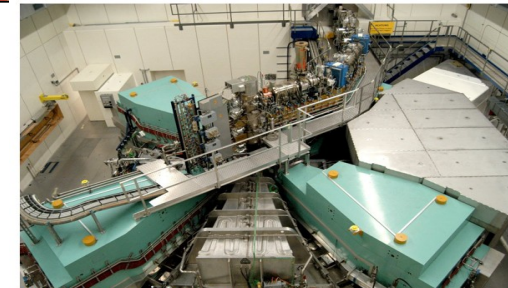

Nowaday's 72 MeV injector

Injector 2 Cyclotron for 72 MeV proton beams.

### Description

The PSI Injector 2 cyclotron has been built to replace the multiparticle variable energy Injector 1 590 MeV Ring cyclotron. The Injector 2 is itself a ring cyclotron, but with 4 sectors instead of 6 and with an automatic



# Neutron production at SINQ

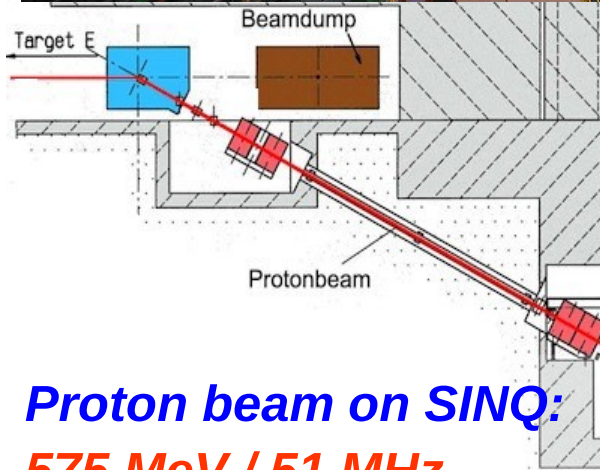
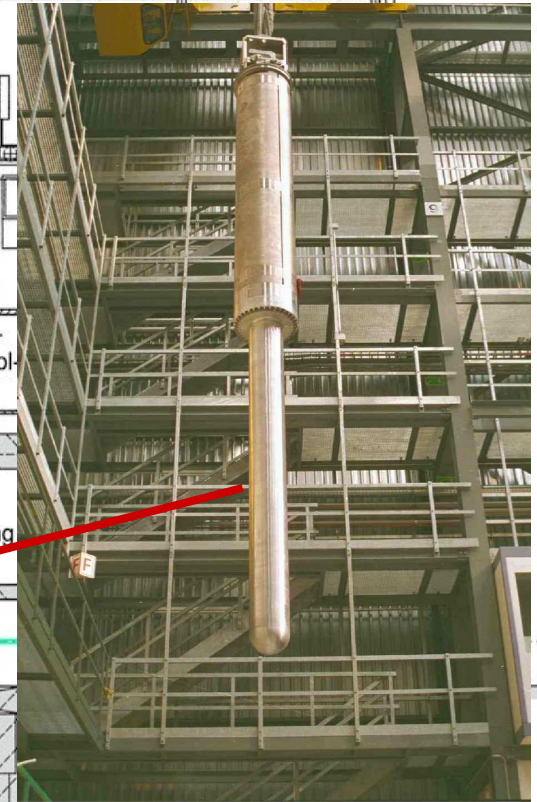
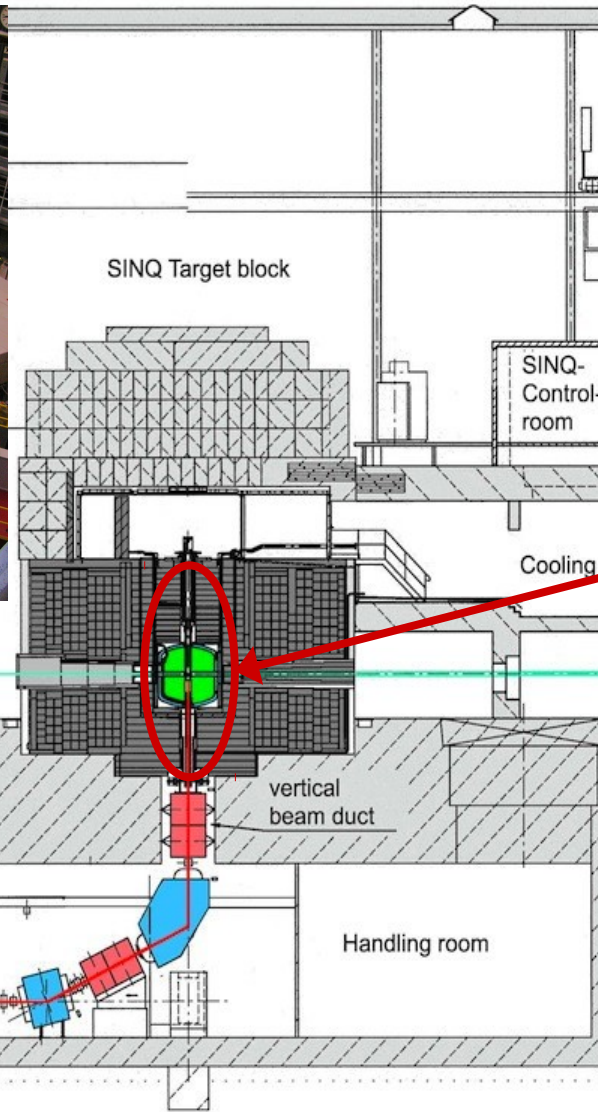
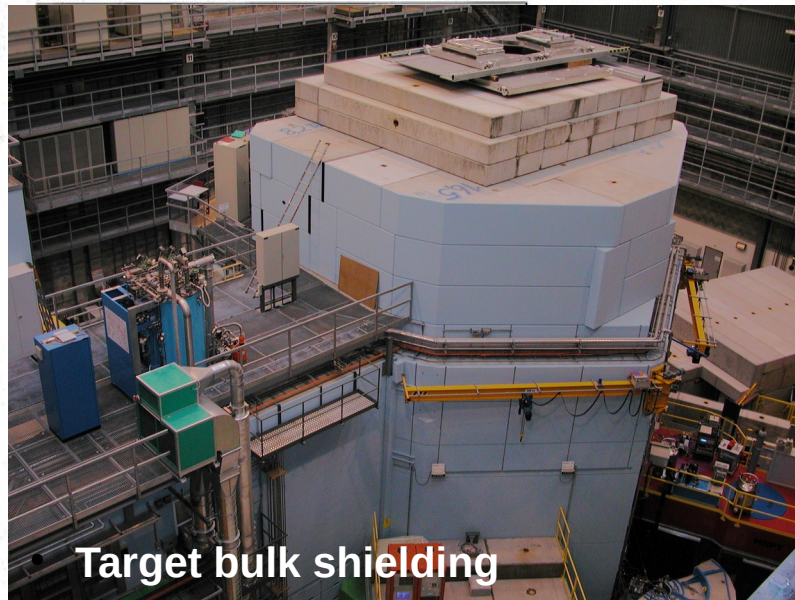

**Proton beam on SINQ:**  
**575 MeV / 51 MHz**  
**p-Current: 1.5 / 1.6 mA**  
**Power: 0.8 - 0.9 MW**

**Total Power Deposition  
in Target Assembly  
~ 575 – 610 kW**



# Application of cyclotrons (ex. 2/2)

## Medical cyclotrons by IBA industrial company



Figure 2. IBA 230 MeV resistive cyclotron for proton therapy



Figure 3. Gantry Treatment Room of the IBA Proteus Proton Therapy System

Ref.: Proceedings of CYCLOTRONS 2010, Lanzhou, China,  
REVIEW ON CYCLOTRONS FOR CANCER THERAPY, Yves  
Jongen#, IBA, Louvain-la-Neuve, Belgium

**Protontherapy at the PSI  
national research center  
(uses a 250 MeV  
superconducting cyclotron)**

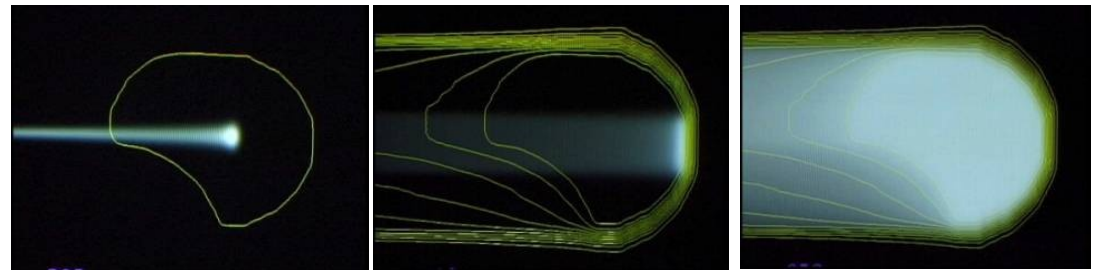

**Spot-scanning technique, developed at PSI**

**Through the scanning and superposition of dose-spots of a proton pencil beam, the desired dose distribution can be built up, and the dose can be precisely tailored to the 3-dimensionnall shape of the tumour.**

Ref.: <https://www.psi.ch/protontherapy/center-for-proton-therapy>

# Application of cyclotrons (ex. 2/2)

## Cancer tumor treatment “protontherapy”

### Bragg peak

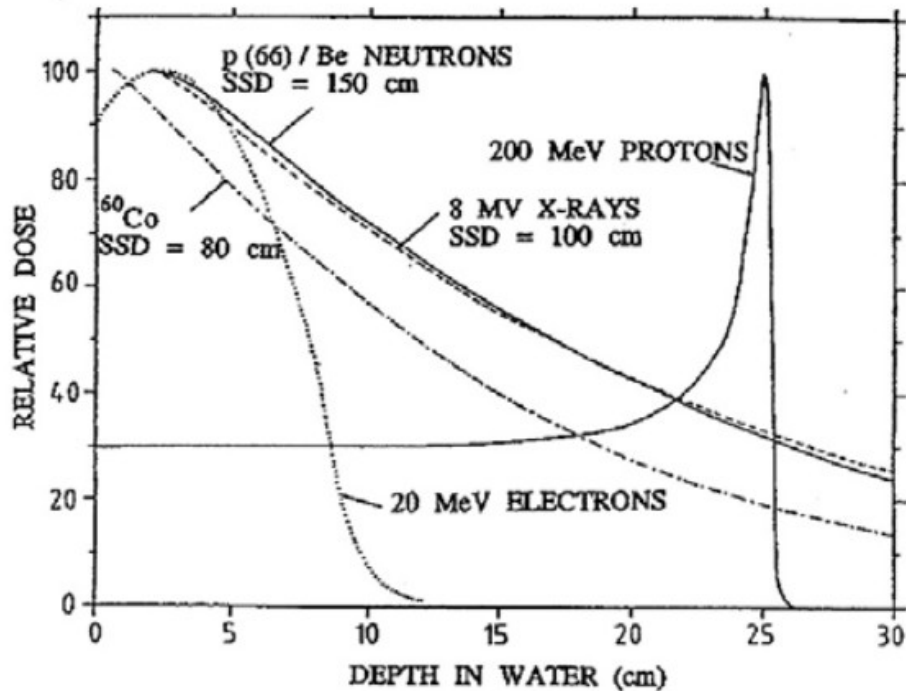

### Spread out Bragg peak

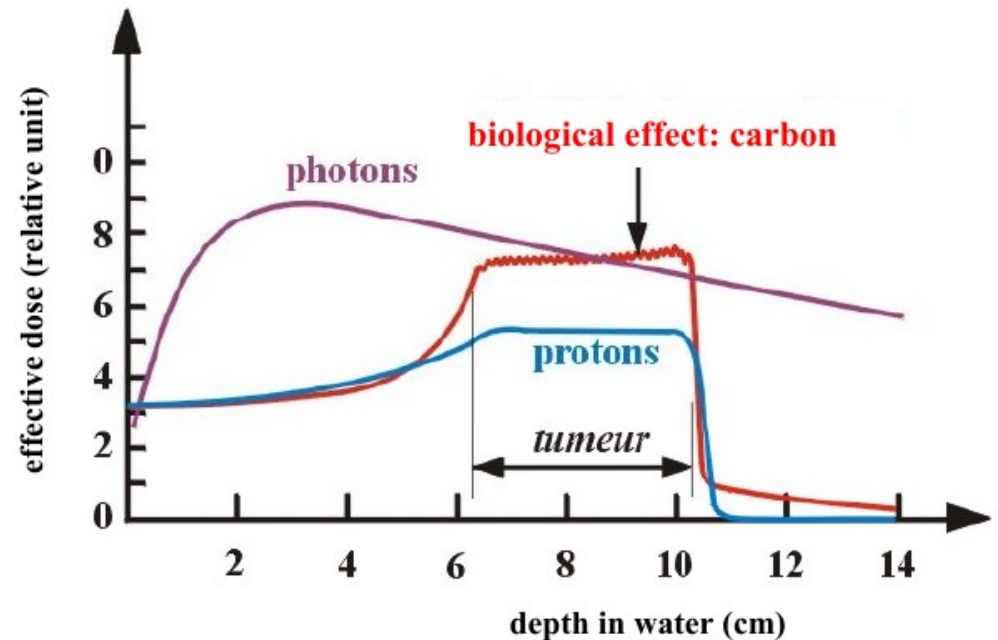

### 3D conformal irradiation

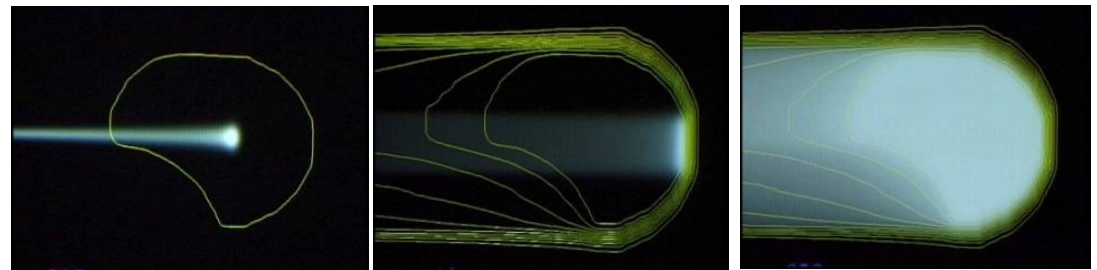

**Where cyclotrons  
come from**



# Cyclotron (1/5)



1939

For his invention of the cyclotron

- 1929-1930, Ernest O. Lawrence inspired by Wideroe & Ising ideas invents (the principle of) the cyclotron : having read Wideroe's paper, he speculated on the use of a magnetic field to bring the particle back to a *single* accelerating gap next to acceleration.

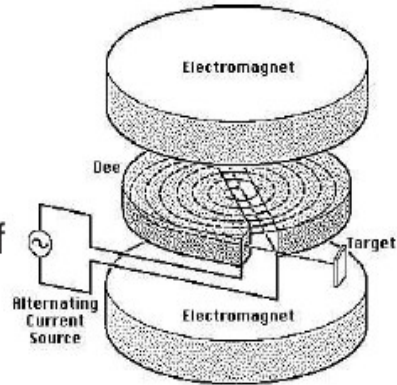

- Doing so he found that the revolution frequency in uniform B is constant : the "cyclotron angular frequency",  $\omega_0 = qB/m$
- That allows RF gap voltage at constant frequency,  $f_{RF} = qB / 2\pi m$ .

- 1931, Stanley Livingston, Berkeley, demonstration with 5-inch cyclotron by acceleration of hydrogen ions up to 80 KeV (about 40 turns up to  $r \approx 4.5$  cm).
- 1932,  $\phi 30$  cm cyclotron built by Lawrence produces protons at 1.25 MeV and breaks atoms *a few weeks after Cockcroft-Walton's Li + p*
- 1934, Berkeley, E.O. Lawrence builds a 27-inch cyclotron, accelerates protons to 3 MeV and D to 5 MeV
- 1939, E. O. Lawrence receives the Nobel Prize "for the invention and development of the cyclotron and for results obtained with it, especially with regard to artificial radioactive elements".

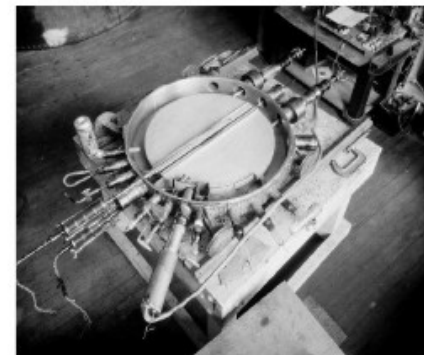
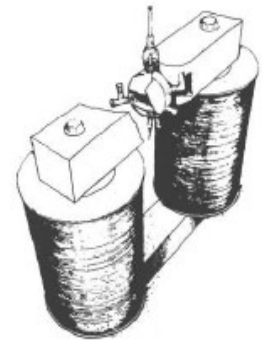

The device is inserted in the gap of an electromagnet.

- That was just the beginning of a lasting story, yet...

# Cyclotron (2/5) - classical

With  $B$  constant in time and uniform in space, as particles gain energy from the rf system, they stay in synchronism, but spiral outward in  $r$ .

- Non-relativistic cyclotron

- orbit :  $r = v/\omega_0 = mv/qB$

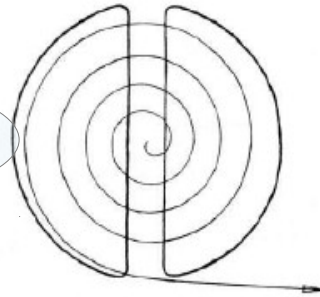

- focusing (1) :

$$F_z = qvB_r \approx qv \frac{\partial B_r}{\partial z} z \equiv qv \frac{\partial B_z}{\partial r} z$$

$$\ddot{z} - \frac{qv}{m} \frac{\partial B_z}{\partial r} z = 0 \rightarrow \omega_z^2 / \omega_0^2 = \nu_z^2 = -\frac{r}{B_z} \frac{\partial B_z}{\partial r} = -k, \quad \nu_z = \sqrt{-k}$$

hence the field index  $k$  needs be negative :  $B_z$  is slowly decreased with radius.

Similarly,  $\nu_r = 1 + k$ . This sets the requirement  $-1 < k < 0$

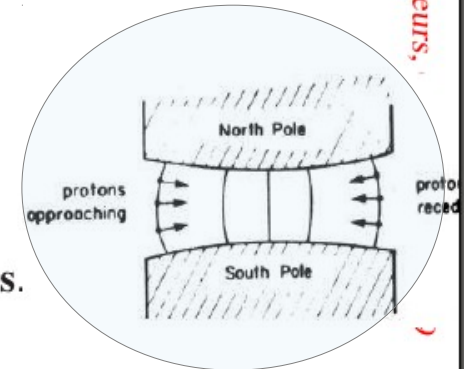

- focusing (2) : is also ensured at lower energy by the electric field.

- isochronism :

The condition for vertical focusing,  $-1 < k < 0$  ( $B$  is not constant), spoils the isochronism.

As a consequence, the phase is not constant (ABCDE path)

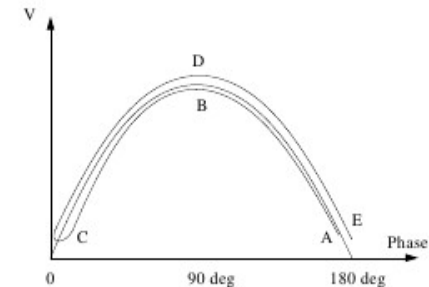

- bunching : particle beam injected into the cyclotron necessarily gets bunched, at the frequency of the RF (the time interval between two bunches is an RF period)

- The classical limit ( $\gamma \approx 1$ ) is  $\sim 25$  MeV for protons, 50 MeV for D and  $\alpha$ , (about 2 – 3% increase in mass), GANIL in Caen accelerates Carbon to about 100 MeV/u...

- That was enough energy to transmute all nuclei... The classical cyclotron allowed discovering oodles of nuclear reactions and isotopes.

Yet, let's keep in mind : transmutation was not the all story

## Cyclotron (3/5) - classical

- Relativistic energies, the bad news :

- The cyclotron resonance  $\omega_0 = qB/\gamma m$ , with  $r = \beta c/\omega_0$  yields  $k = \frac{\beta}{\gamma} \frac{\partial \gamma}{\partial \beta} = \beta^2 \gamma^2$

- so  $k$  cannot satisfy  $-1 < k < 0$ ,

isochronism requires that  $B(r) \propto \gamma$ , which yields vertical defocusing...

- That was the end of the story,  $\sim 25$  MeV protons, etc... :

Hans Bethe (1937) :

**The “encouraging” comment...**

“... it seems useless to build cyclotrons of larger proportions than the existing ones... an accelerating chamber of 37 cm radius will suffice to produce deuterons of 11 MeV energy which is the highest possible...”

Frank Cole : “If you went to graduate school in the 1940s, this inequality ( $1 < k < 0$ ) was the end of the discussion of accelerator theory.”

- Until...



**... smarter !**

## Cyclotron (4/5) - Thomas focusing

- 1938, L.H. Thomas, "The Paths of Ions in the Cyclotron", introduces the "Thomas focusing", based on separate sector bending, namely, "edge-focusing",
- 1954, Kerst, spiral edges increase vertical focusing further  
$$\nu_z = \sqrt{-k + F^2(1 + 2 \tan^2 \xi)}$$
$$F = \text{Flutter} = \frac{\langle B^2 \rangle - \langle B \rangle^2}{\langle B \rangle^2}$$
- That allowed having  $B(r)$  increase in proportion to  $\gamma$ , so to ensure constant RF frequency ( $\omega_0 = qB/\gamma m$ ), while *preserving vertical focusing*.
- Modern cyclotrons still rely on these principles

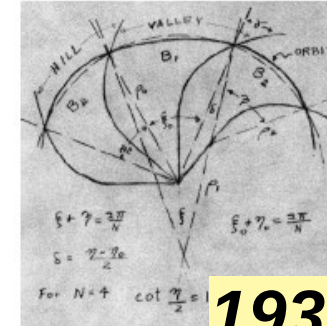

**1930s**

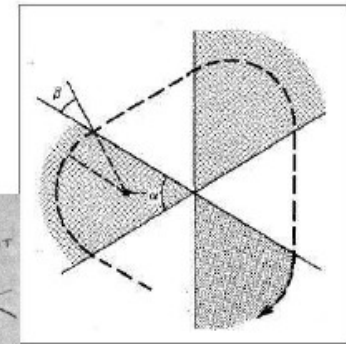

**2000s**

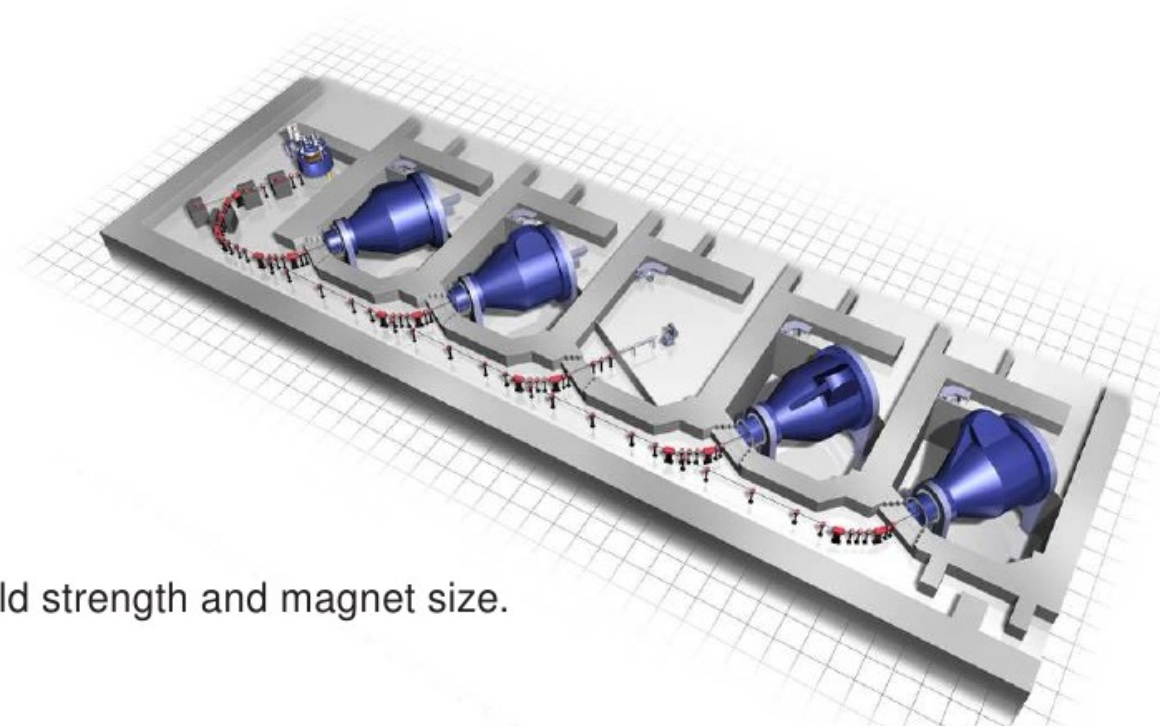

- Cyclotron is limited in energy by its field strength and magnet size.



**Cyclotrons,  
going where  
nowadays ?**

# MORE HIGH POWER ?

\* ACCELERATOR-DRIVEN SUBCRITICAL REACTOR \*  
- BNL -

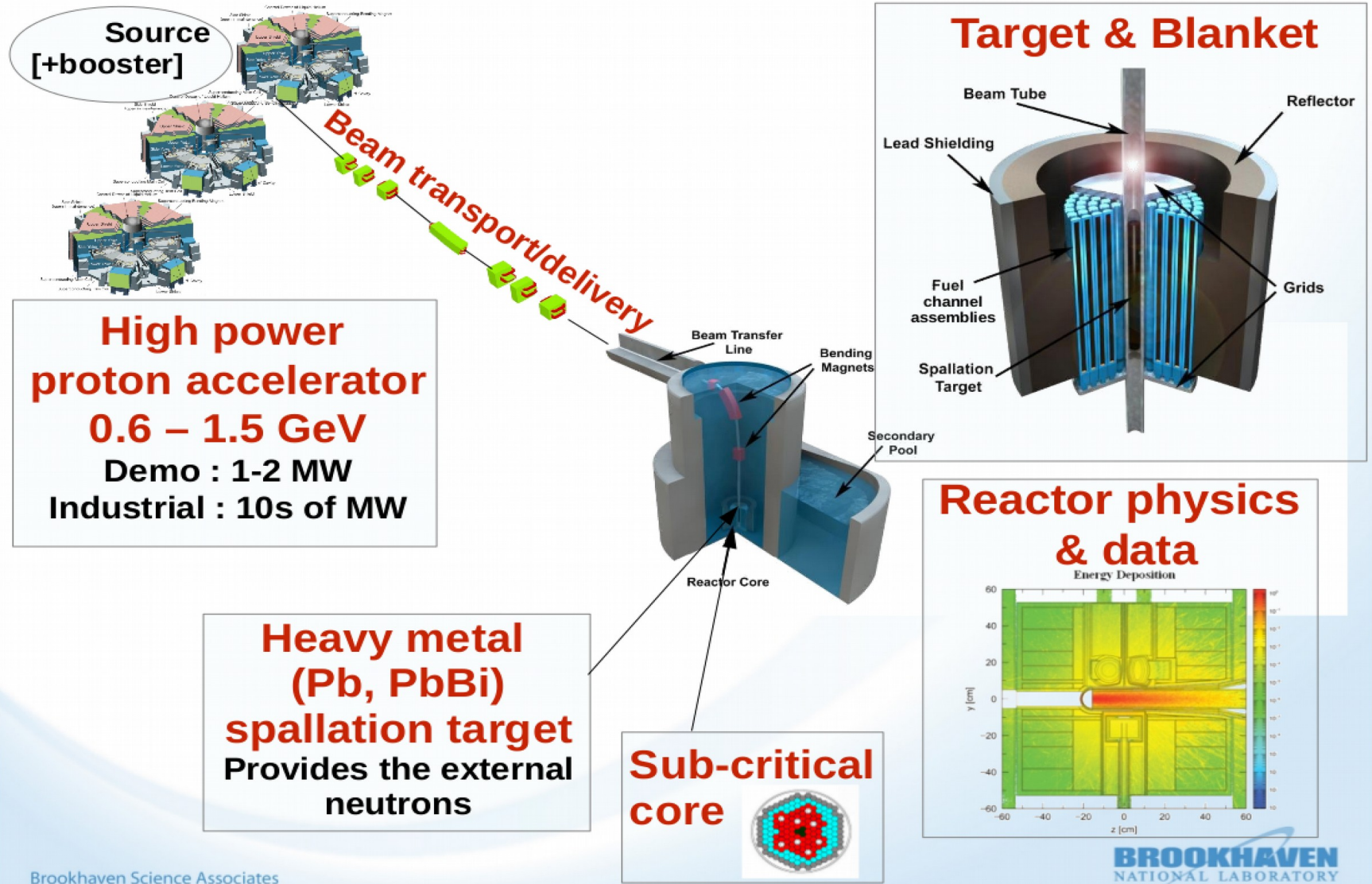

# On-going discussion : which is optimal in the ADS application ?

## Reference : US ADS White Paper (2010)

- **Separate sector cyclotron**

**Paul Scherrer Institute,  
590 MeV, 1.3 MW CW beam  
First beam 1973**



- **Normal conducting proton linear accelerator**

**LANSCCE 800 MeV n science center linac, first beam 1972.  
Ran in 1 mA / MW range in the 1980s,  
120 Hz repetition rate, DC 7.5%.**

- **Superconducting linear accelerator**

**SNS 1 GeV n science linac at ORNL,  
beam power 1.2~1.4 MW.  
Pulsed, DC ~6%. Accelerates H- for  
stripping injection into accumulator ring,  
First beam 2006**





# MEDICAL BEAMS, ISOTOPE PRODUCTION

New, S2C2 technology, MEDICYC, NICE (F)  
250 MeV, super-compact, first beam 2016

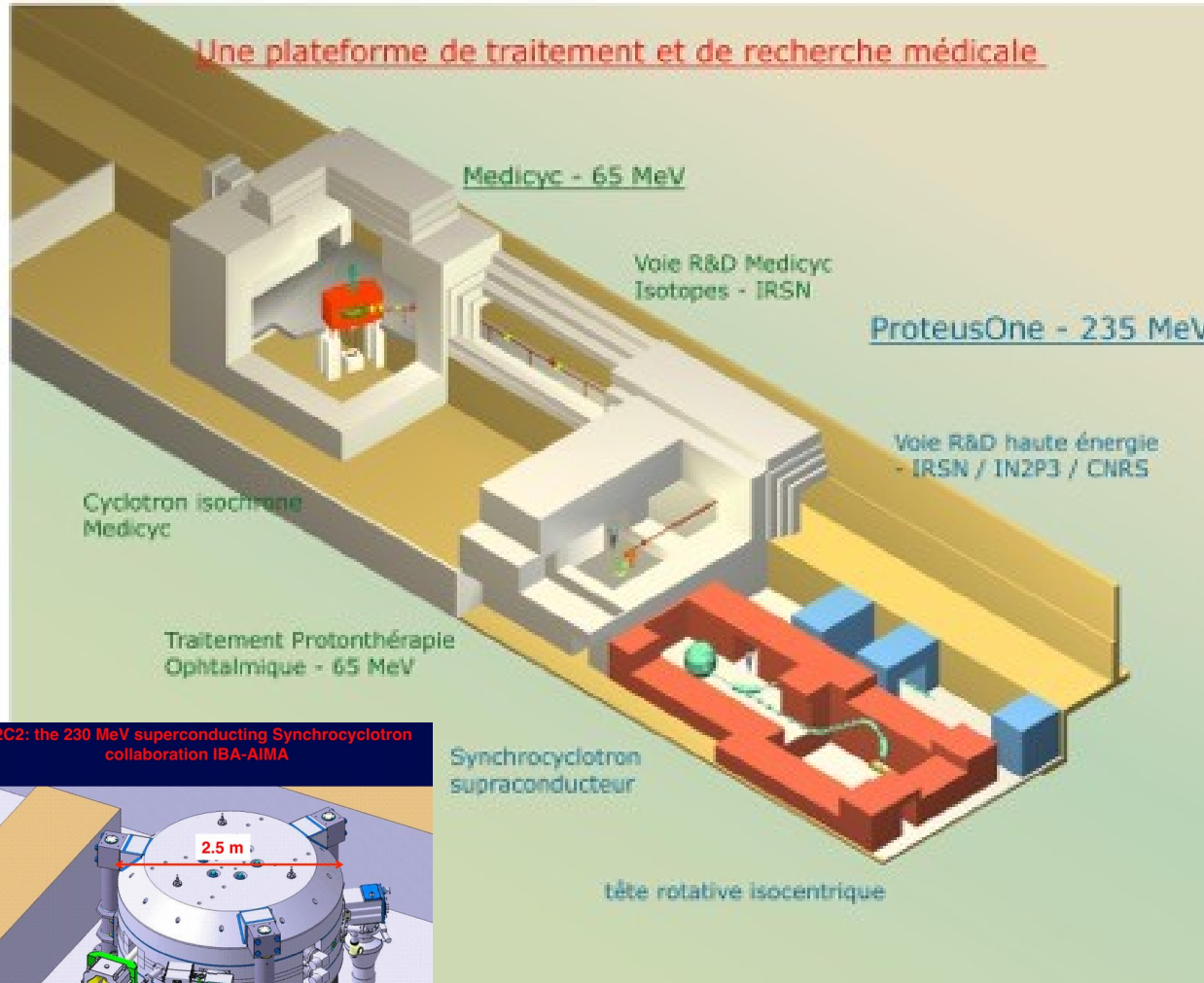

S2C2: the 230 MeV superconducting Synchrocyclotron collaboration IBA-AIMA

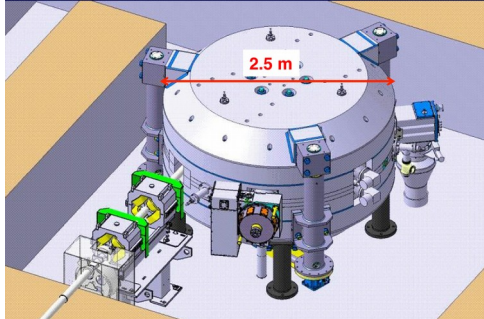

Puebla-telConf-Feb 16th, 2015 P.Mandrillon 17



*(electrostatic accelerators)*

*(betatron)*

*linear accelerators*

*cyclotrons*

*(microtron)*

*(synchro-cyclotron)*

**synchrotron**

*acceleration techniques of the future*

# synchrotron

*Fancy, ~GeV light source style*

## *Basic*

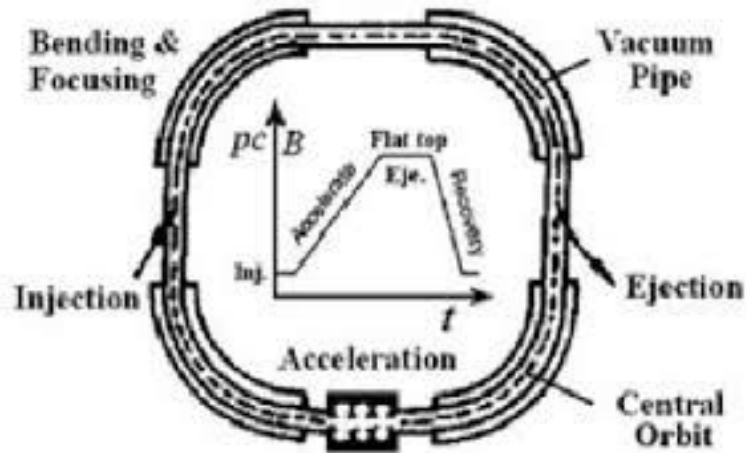

## *Beam focusing + guiding:*

### QUADRUPOLE LENS



+

### BENDING MAGNET

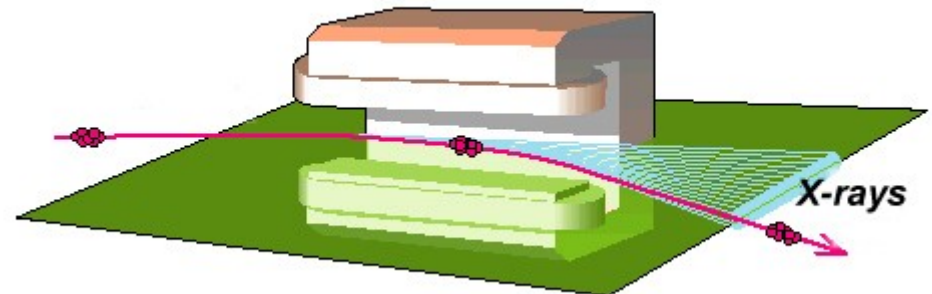

*Synchrotron radiation in bonus!*



# LIGHT SOURCES

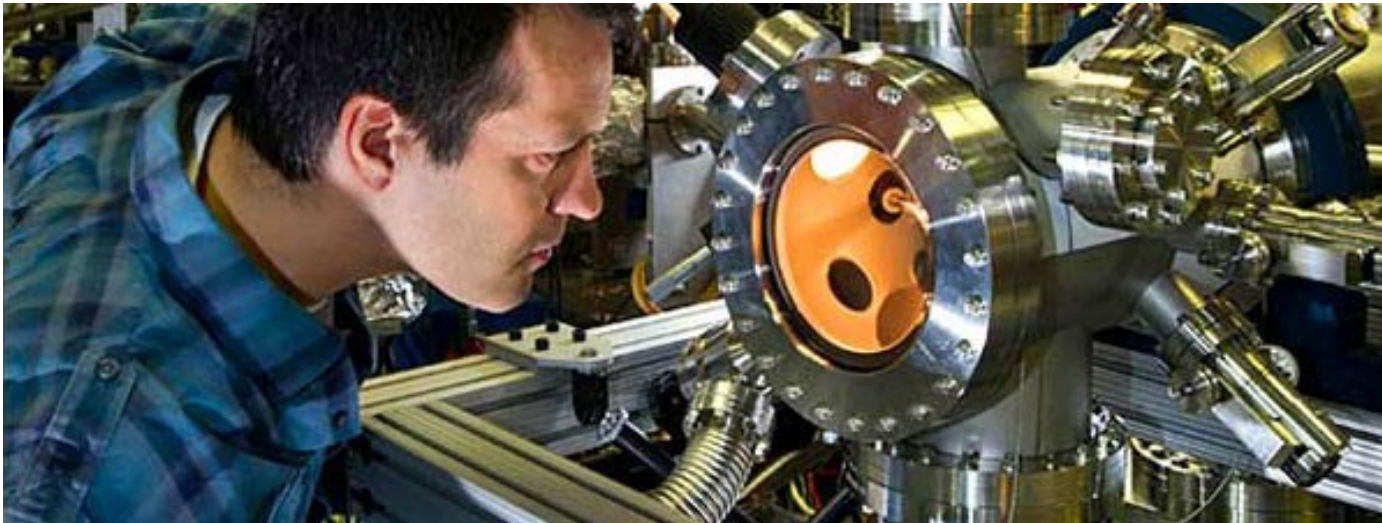

# How this started

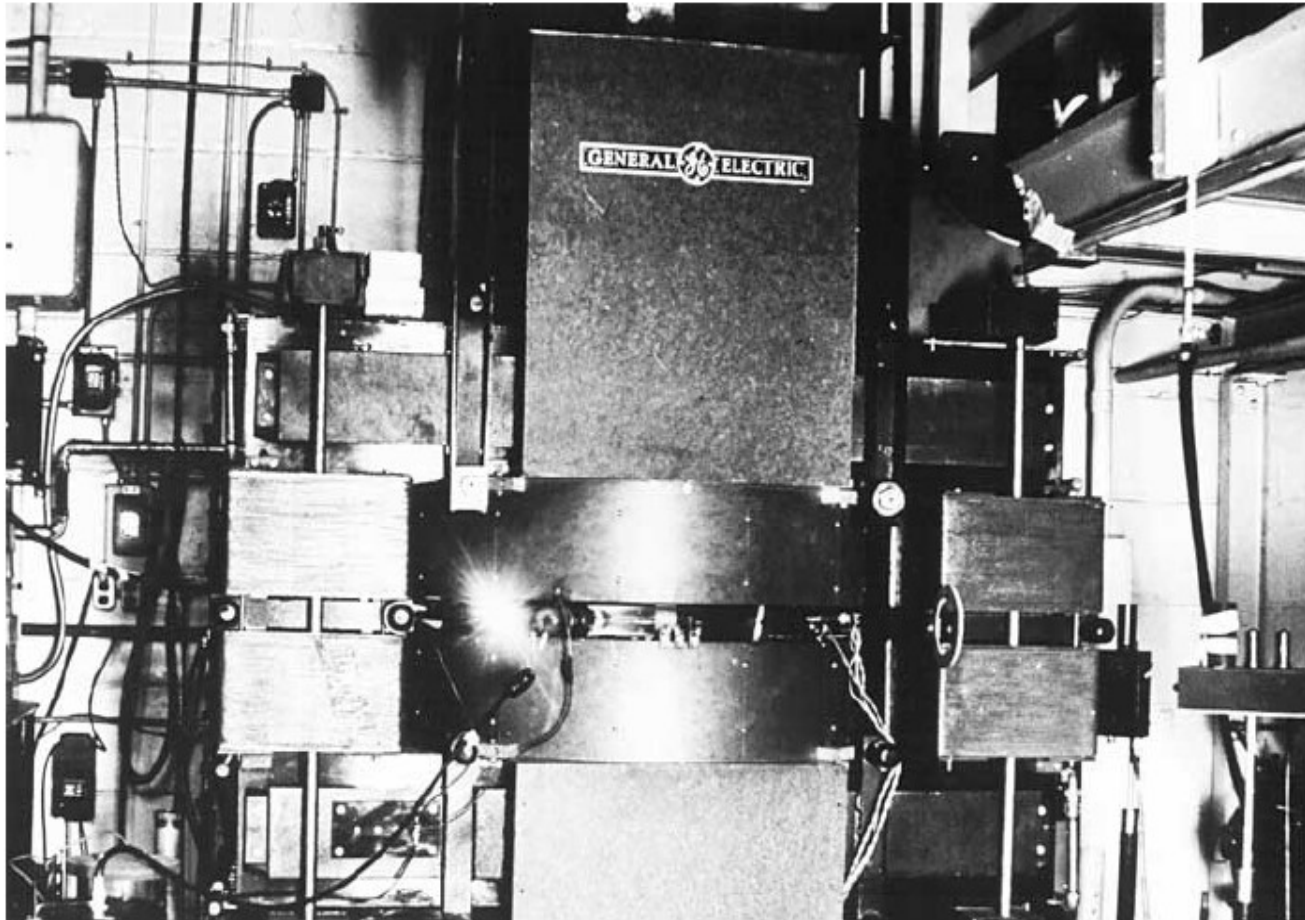

The 300 MeV electron synchrotron built at General Electric Co. in 1940s. The photograph shows the synchrotron radiation emitted from the accelerator.

# NSLS2 3 GeV synchrotron, BNL Started 2015

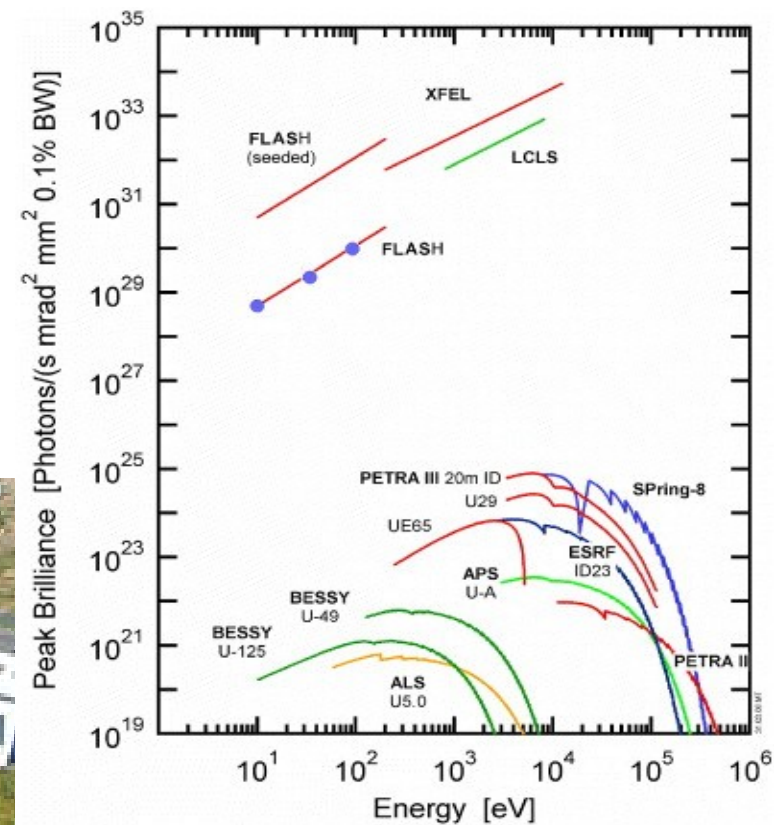



# Nuclear research

**1 of the 2  
LARGE COLLIDERS  
ON THIS PLANET**



# RHIC

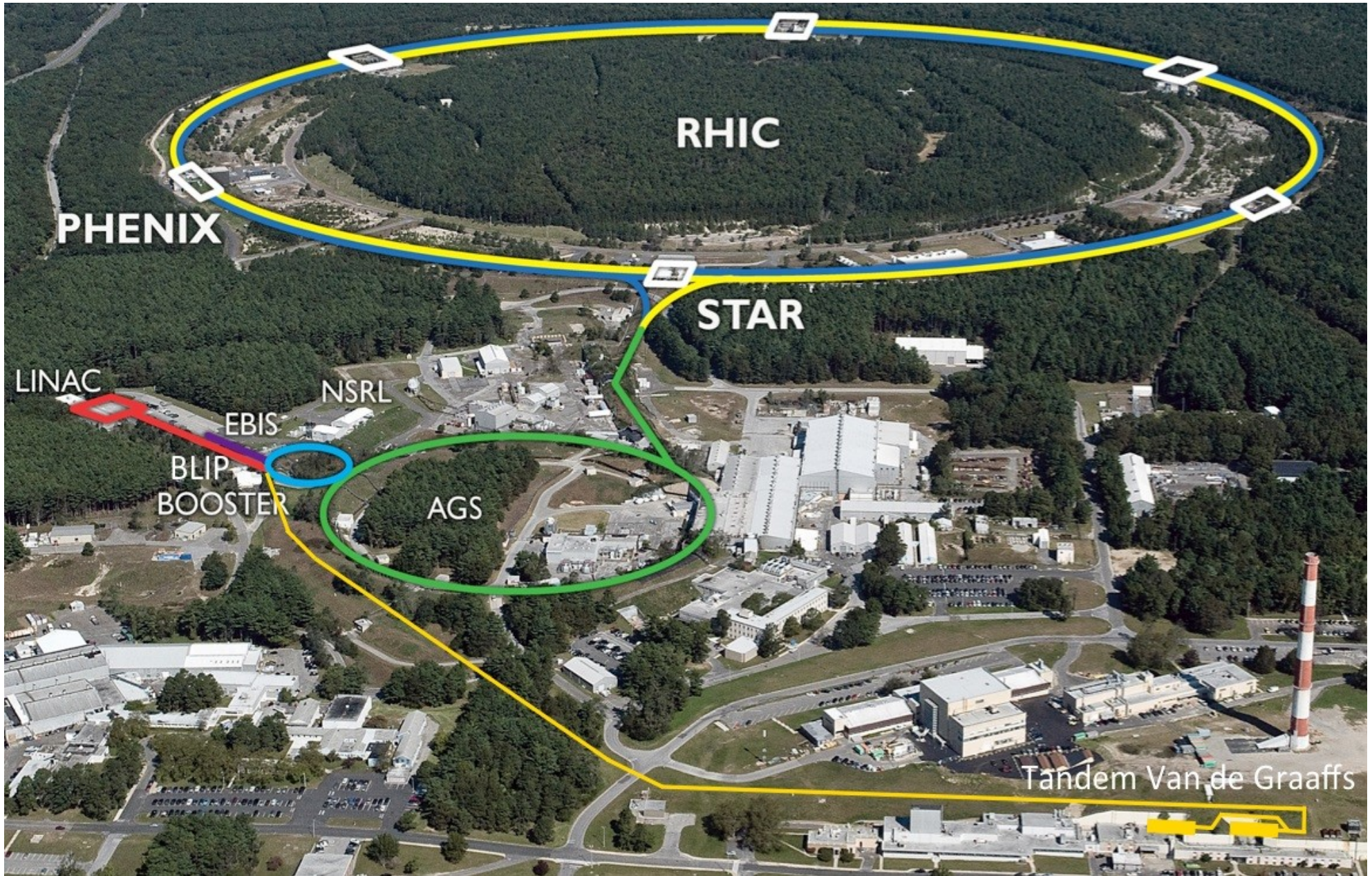



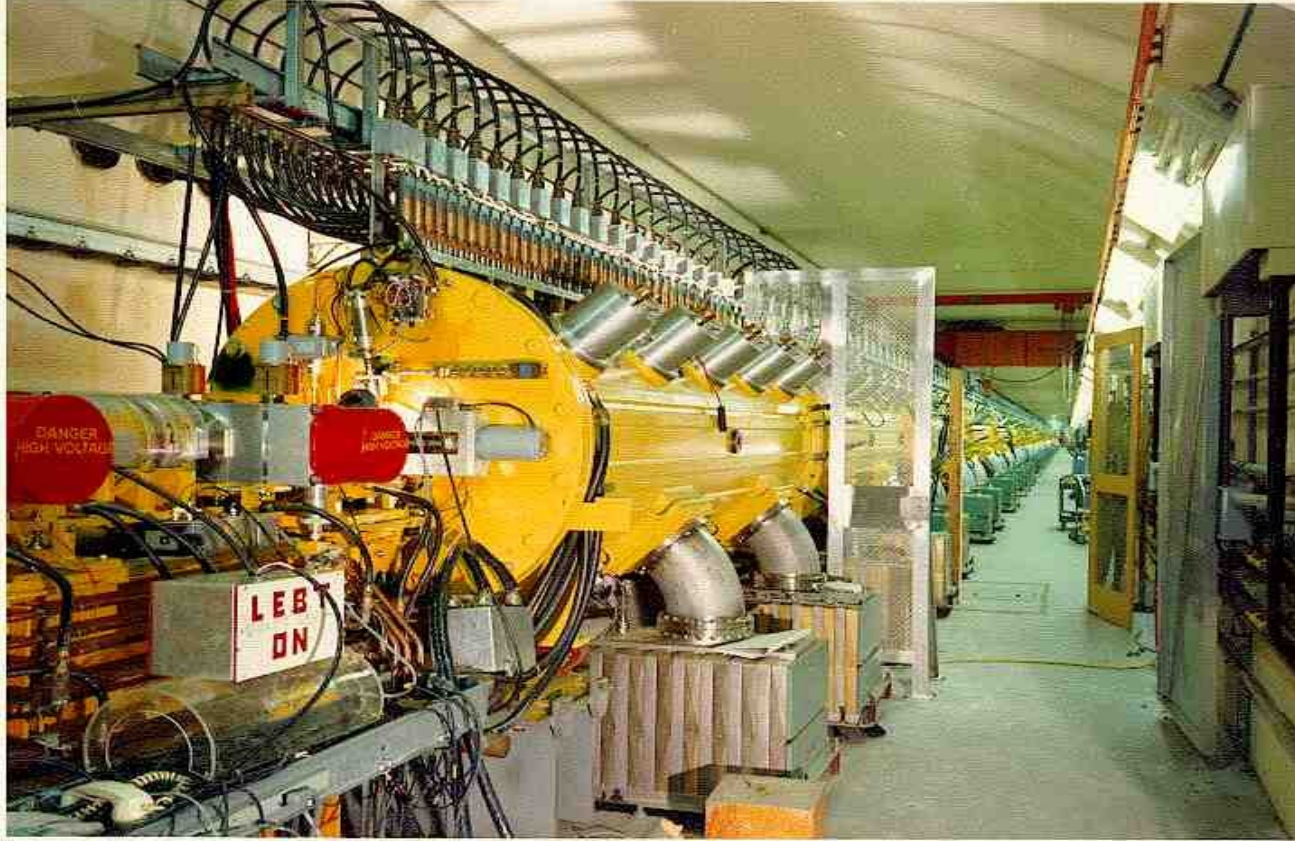



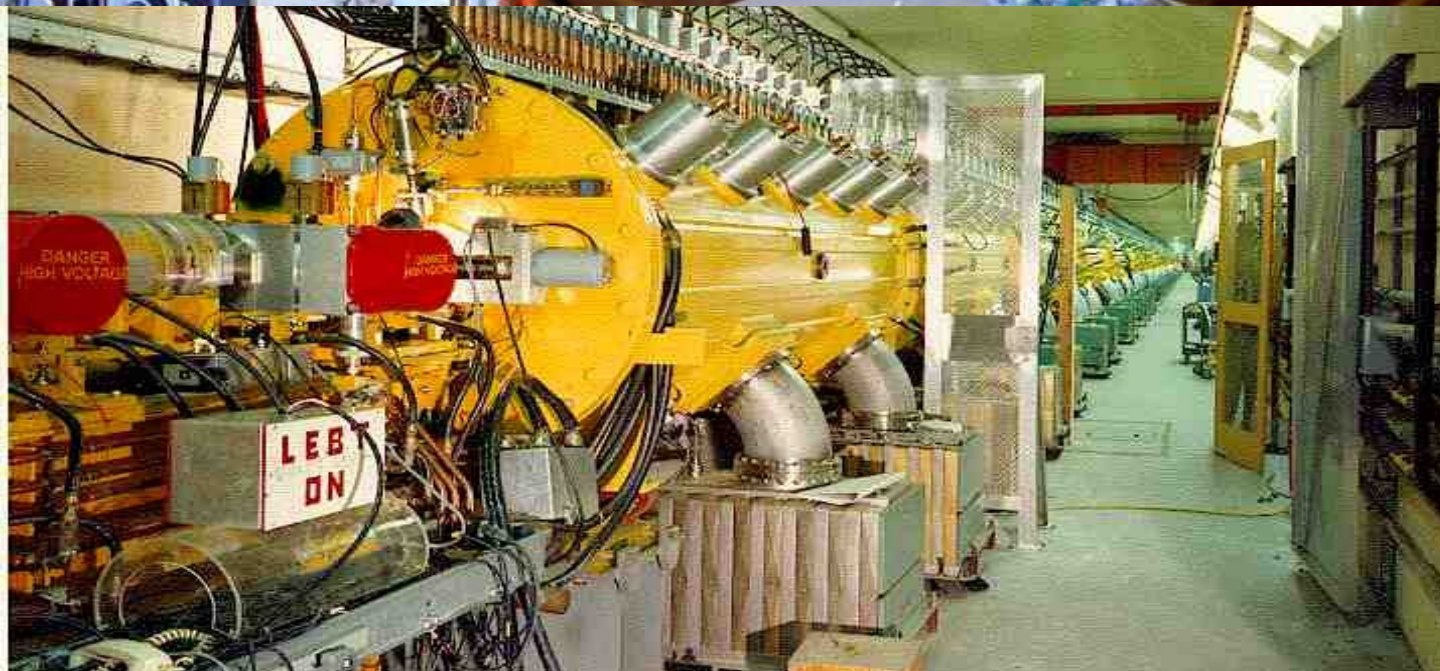



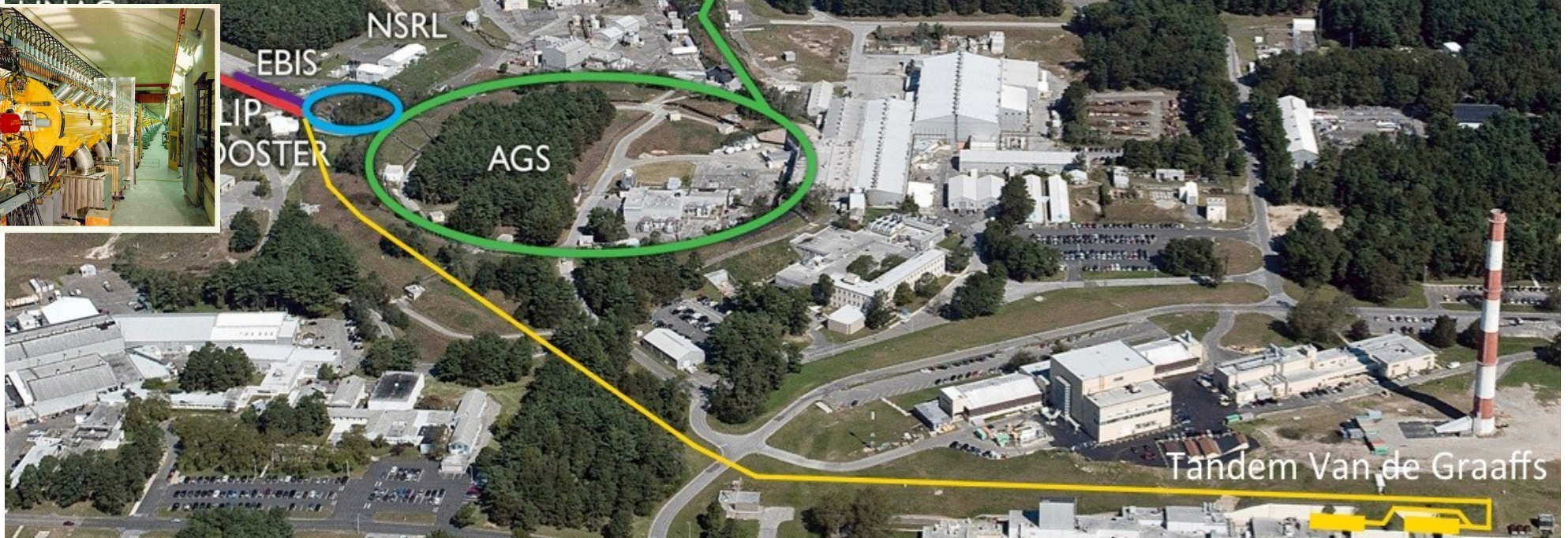
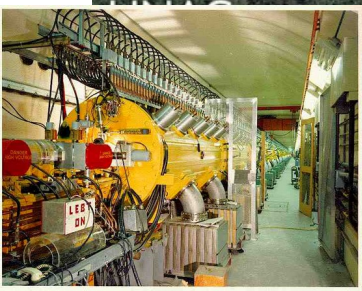
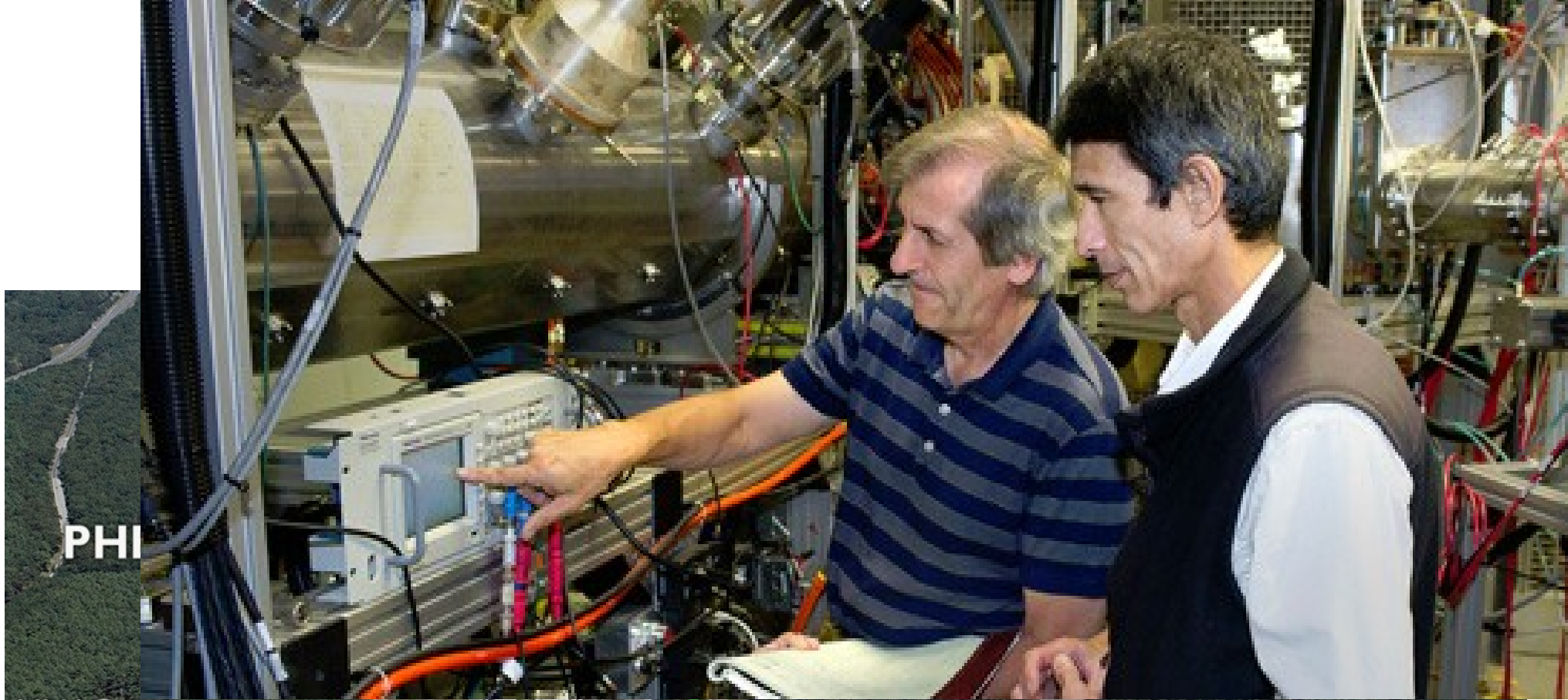





F  
LINA

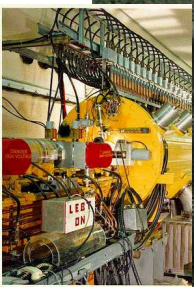

Tandem Van de Graaffs



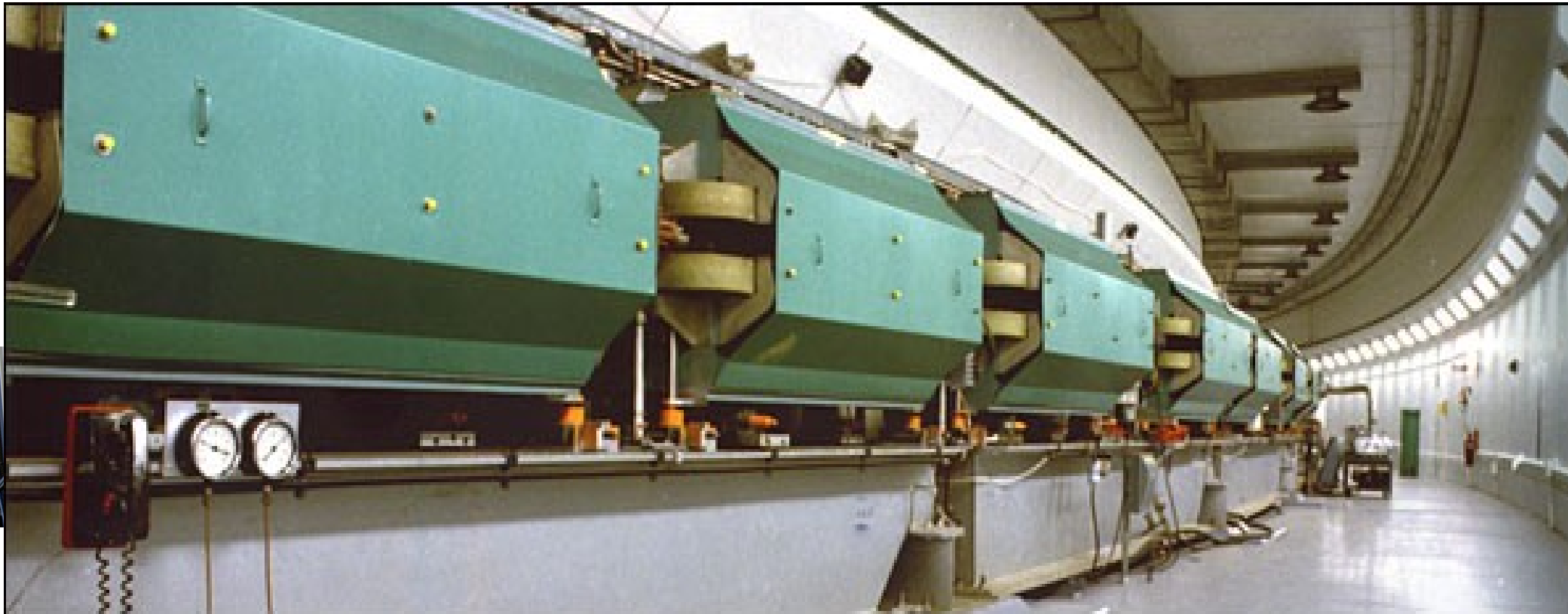



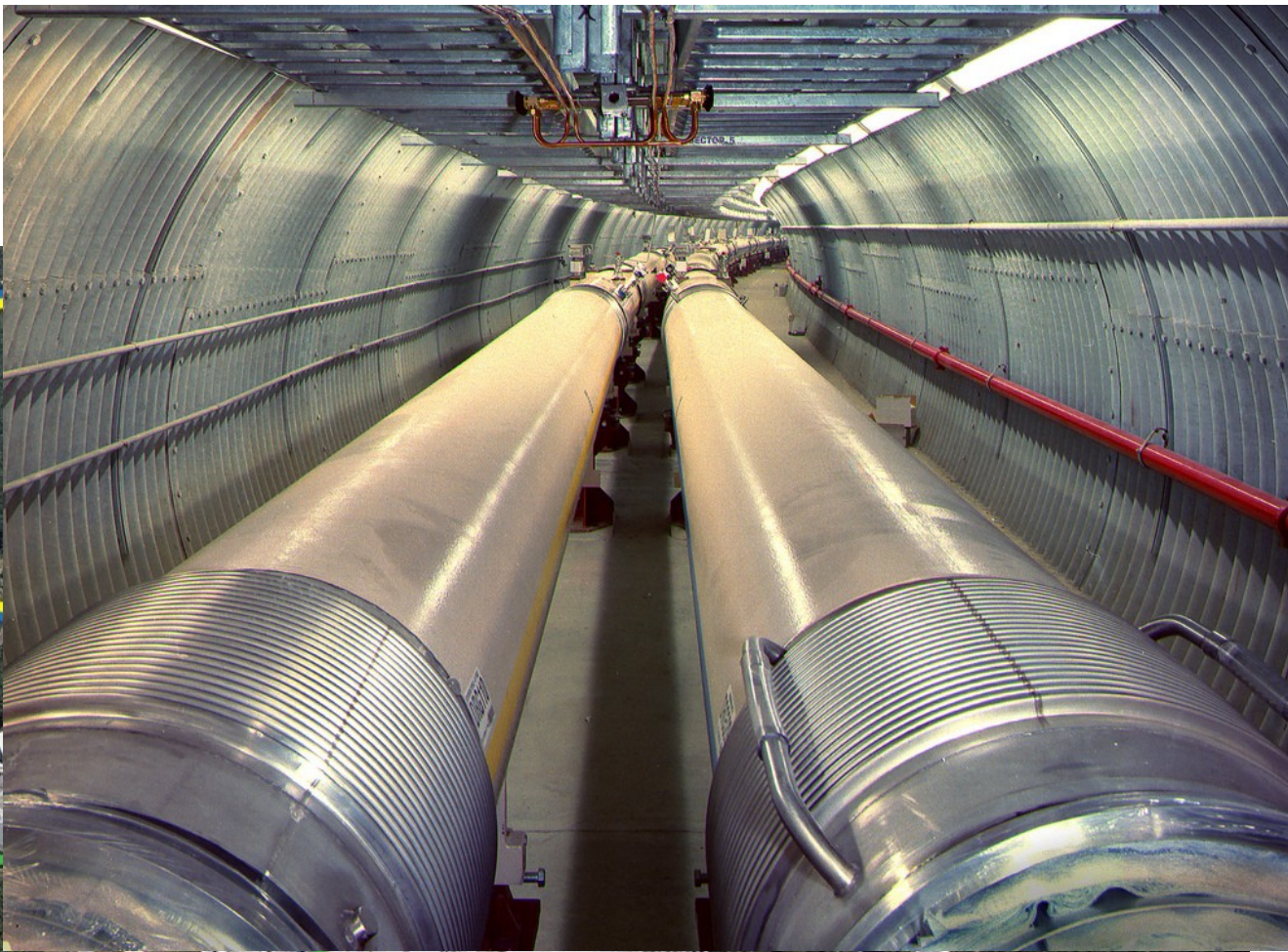
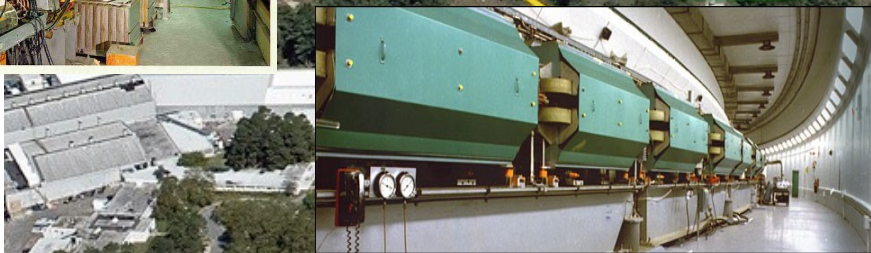
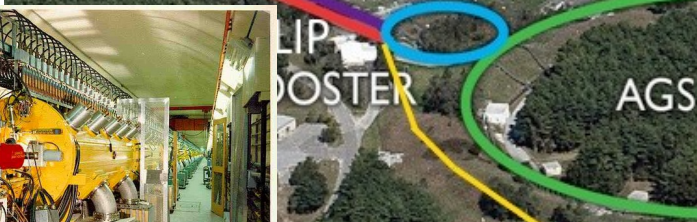

Tandem Van de Graaffs



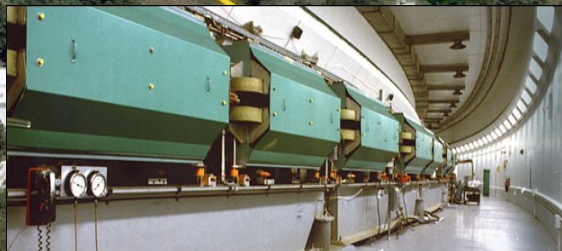
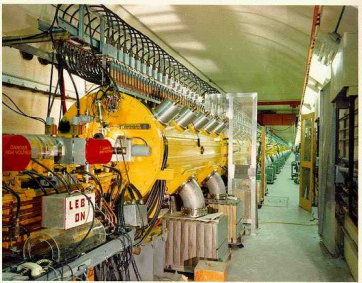
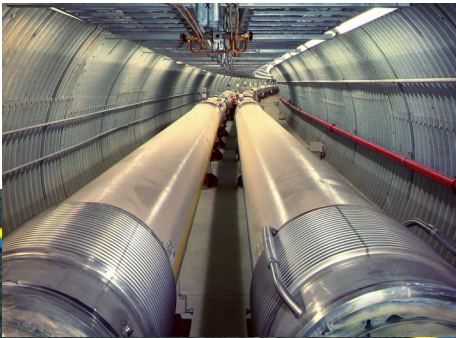
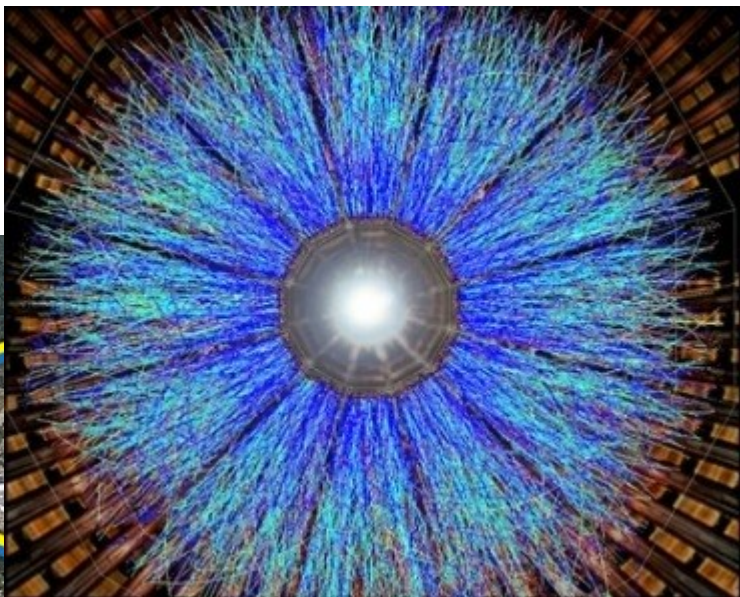
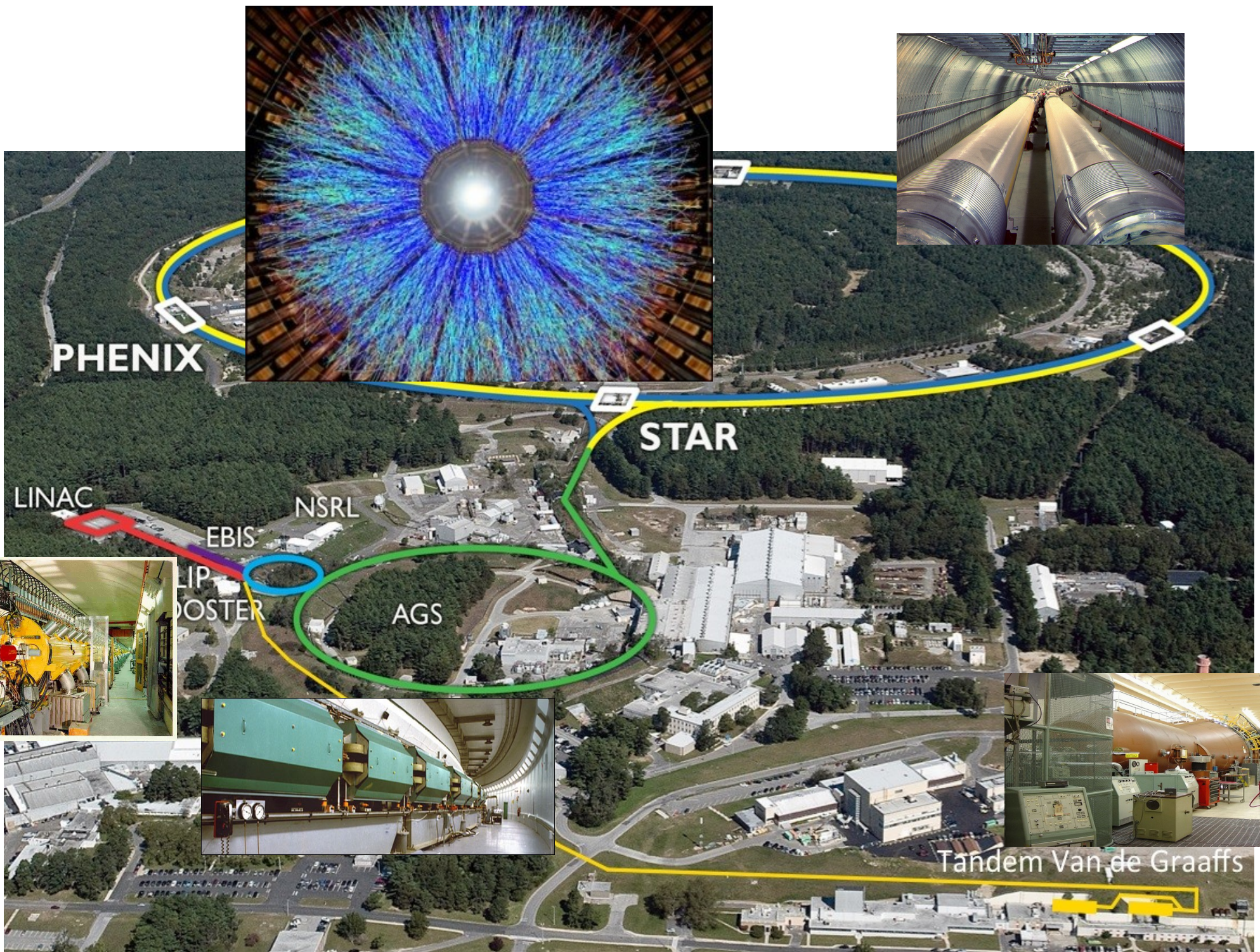

Tandem Van de Graaffs



# HEP

# The largest collider: LHC

Construction started ~2000, first run : 2009

Energy 6.5 TeV per beam, 13 TeV CM

**Discovery of Higgs Boson announced in 2012**

10,000 people from 113  
different countries  
contribute to science at the  
LHC



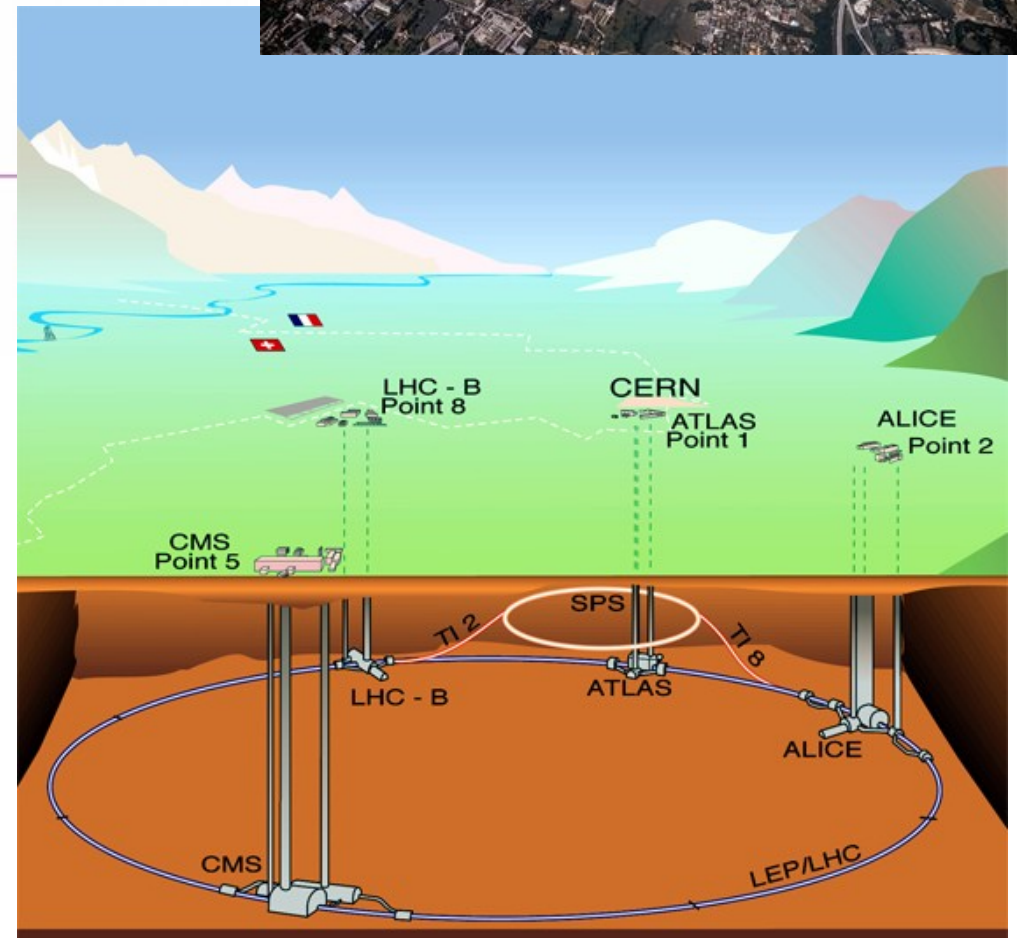
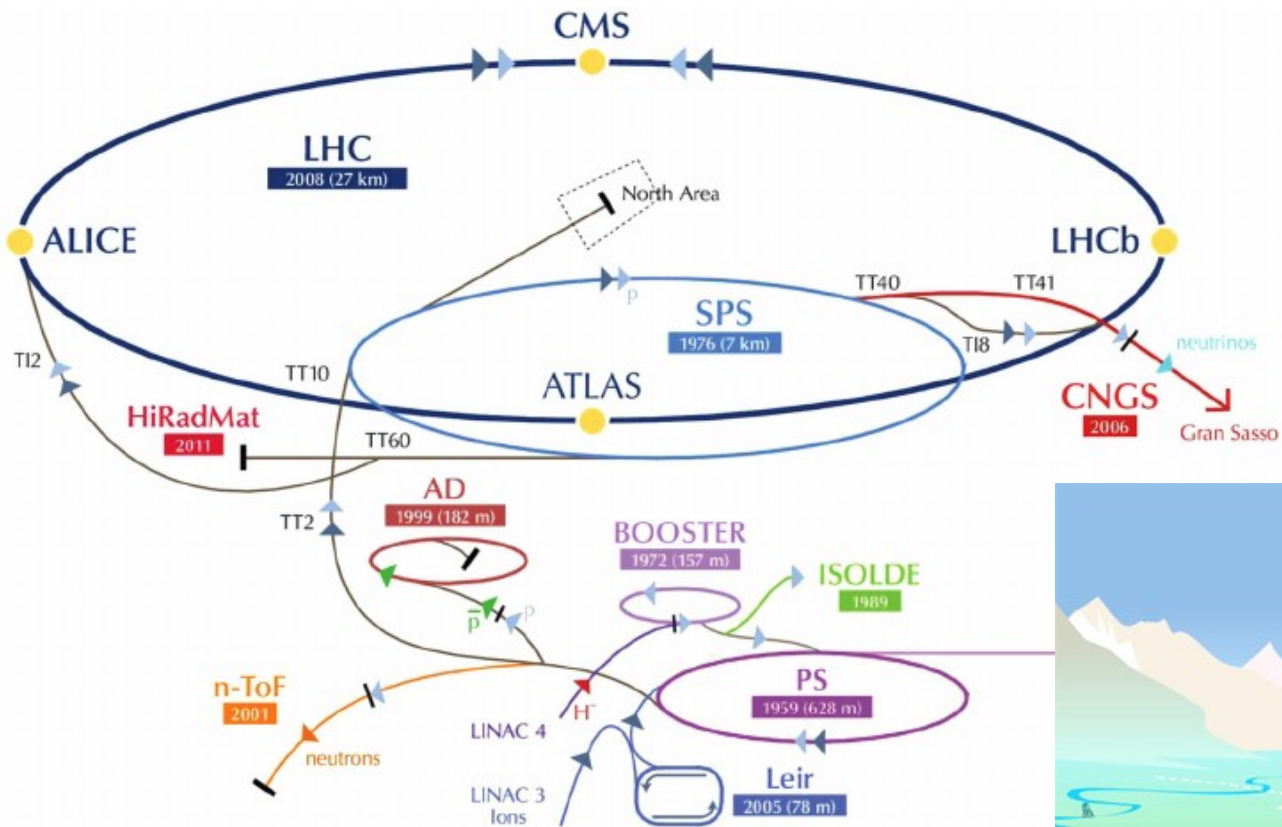

# CERN LHC and injectors



# LHC DIPOLE : STANDARD CROSS-SECTION "2-in-1" design

# Interconnecting magnets

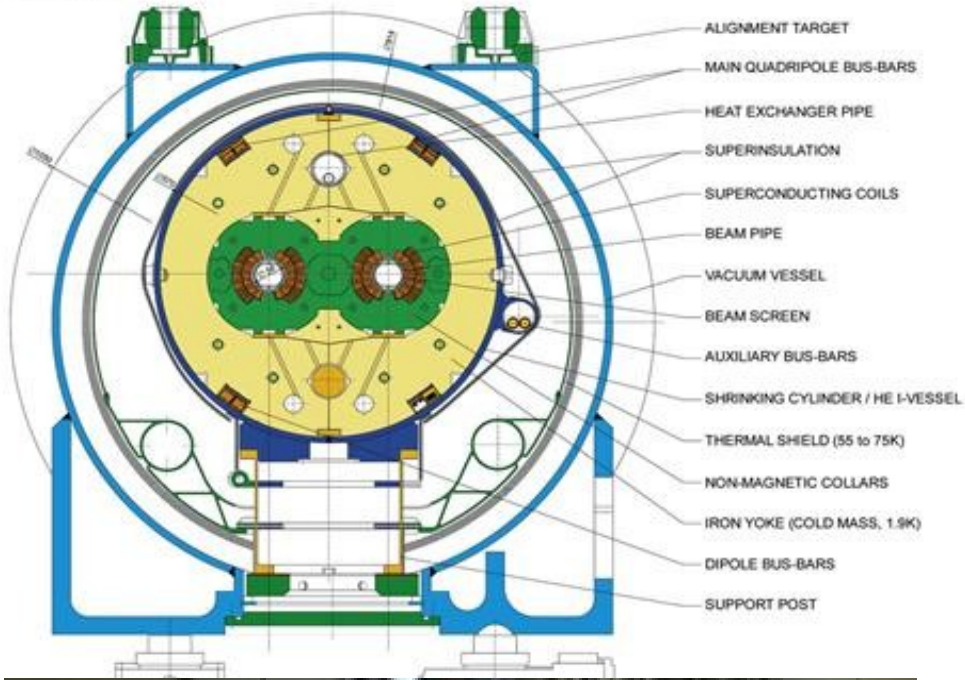



# LHC SUPERCONDUCTING RF CAVITIES

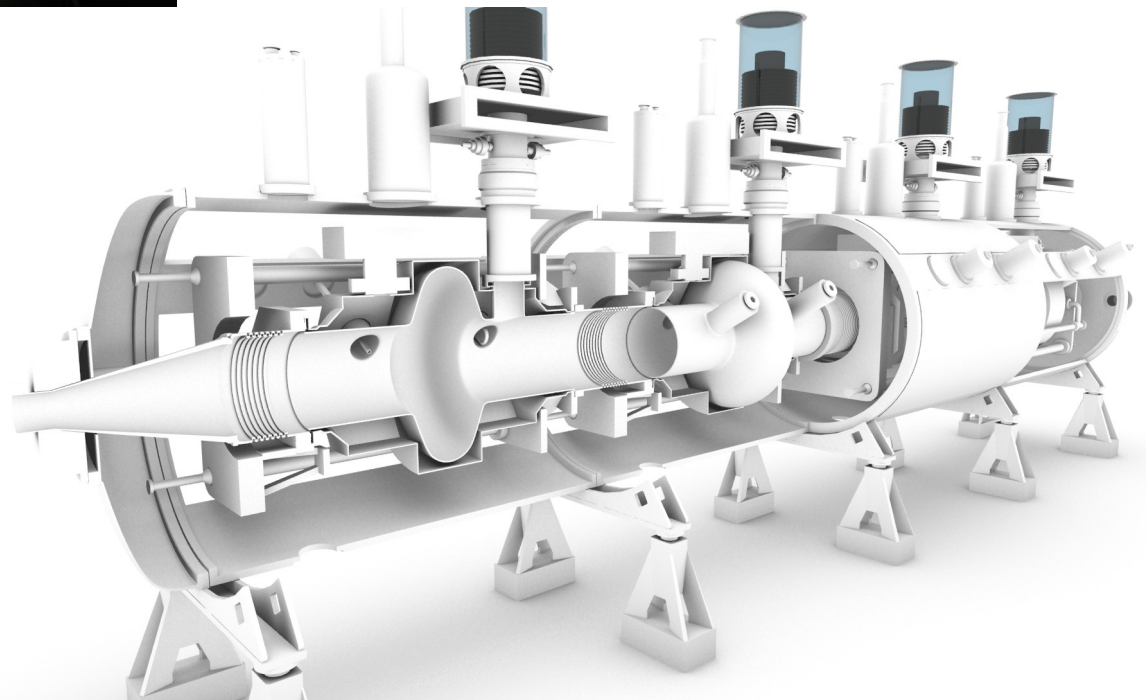



# CONTROL ROOM





# ATLAS DETECTOR

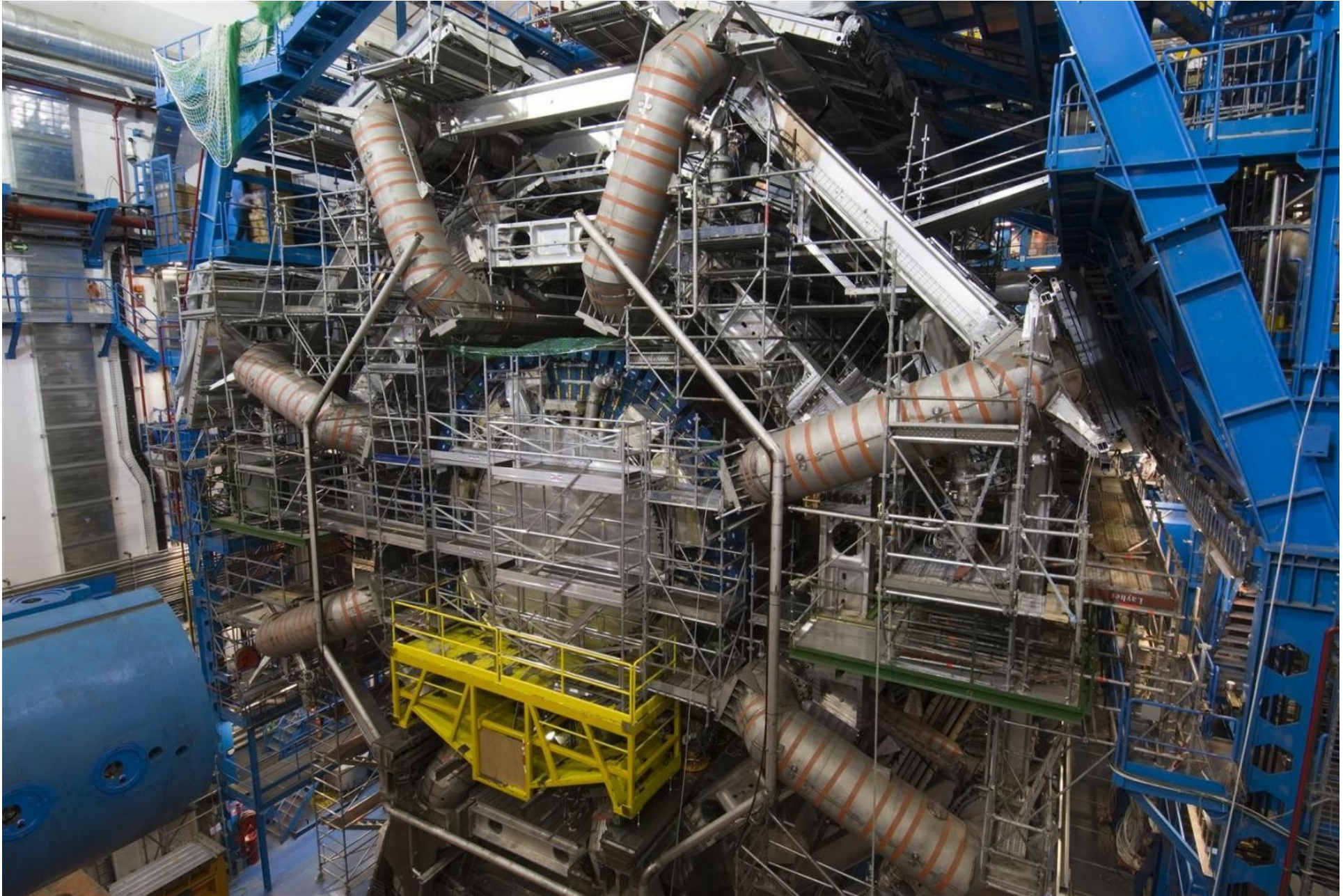



# CMS DETECTOR





**Synchrotrons,  
where from ?**



# 1944-Veksler; 1945-McMillan: discovery of phase stability - “longitudinal focusing”. This is how it works.

## Phase Stability in a Synchrotron

- From the definition of  $\eta$  it is clear that an **increase in momentum** gives
- **below transition** ( $\eta > 0$ ) a **higher revolution frequency** (increase in velocity dominates) while
  - **above transition** ( $\eta < 0$ ) a **lower revolution frequency** ( $v \approx c$  and longer path) where the momentum compaction (generally  $> 0$ ) dominates.

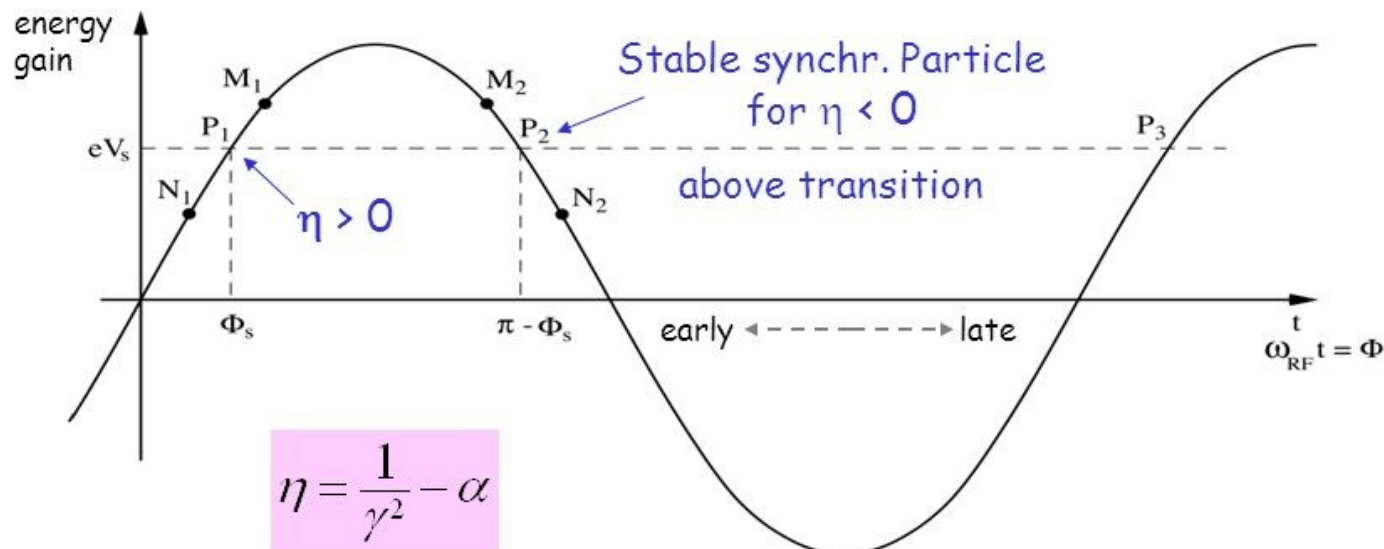

**Cyclotron style “weak focusing” optics, at that time (dipole index  $0 < k < 1$ )**

**1947: First observation of synchrotron light (SR), not fully understood (spectrum etc.) - Julian Schwinger would develop a full theory of SR in a circular accelerator**



**Vacuum chamber of GE synchrotron**

[Ref.:Alamy.com]



**70 MeV synchrtron, GE**

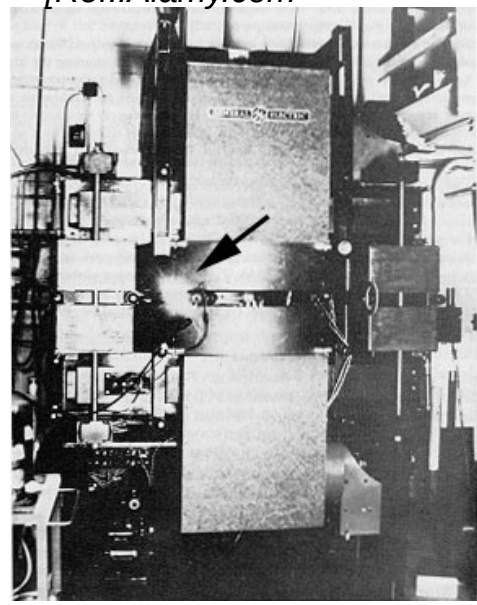

**1946, Aug.: First synchrotron operation, 8 MeV proof-of-principle, by Goward in Woolwich, UK**

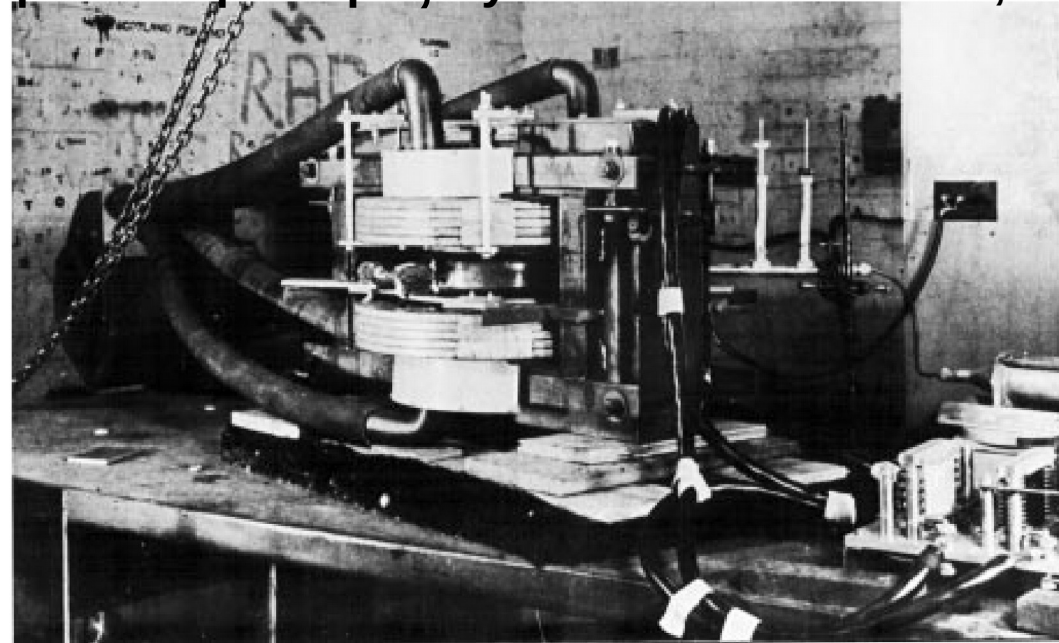

**Fig. 4:** The world's first synchrotron, installed at Malvern. The extra cooling system and RF feed to the resonator may be clearly seen.

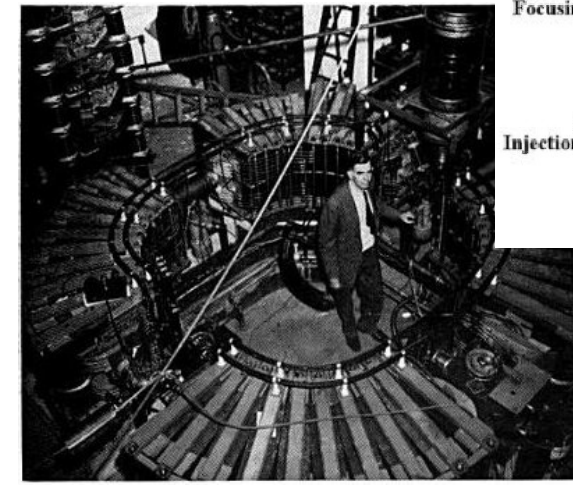

**The first "racetrack" sybnchrotron with straight sections, 300 MeV electron, University of Michigan, 1949.**

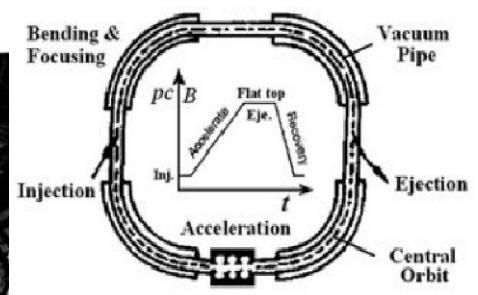



# STRONG FOCUSING : Invented in 1950

Strong index  $|k| \gg 1$  + alternating gradient ( $k < 0, k > 0$ )

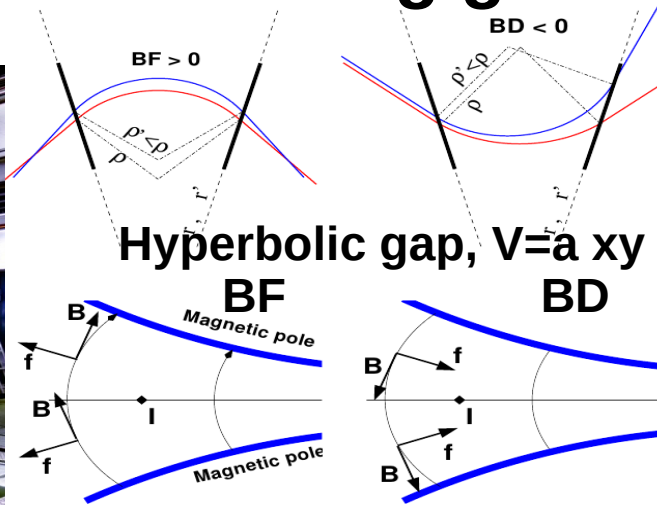
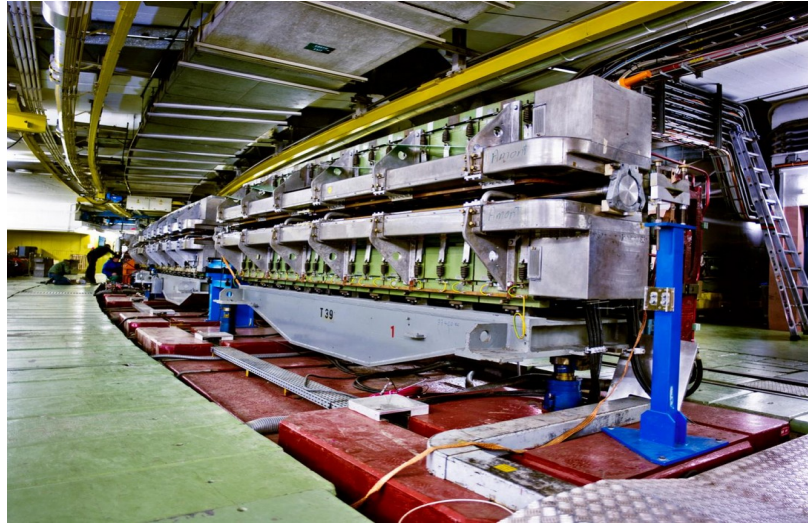

PS (1959), 30 GeV: few cm diameter vacuum chamber



Compare the dipoles:



Cosmotron, 3 GeV:  
1.22m x 0.22m vacuum chamber

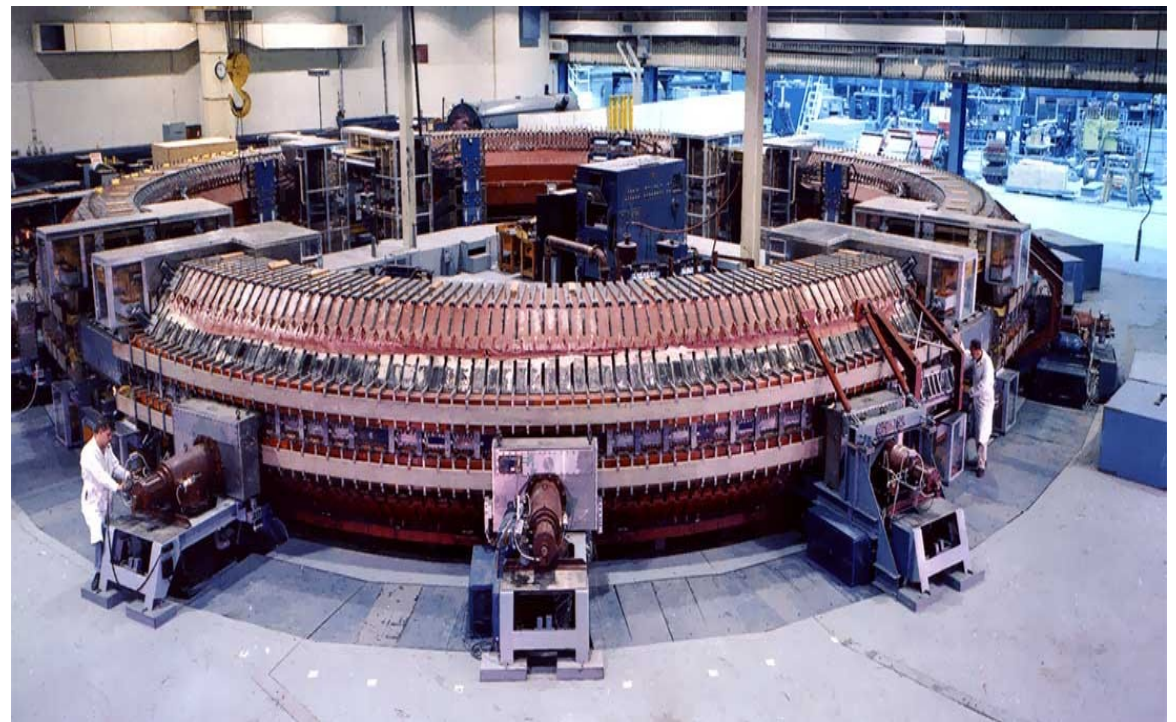

**What's next ?**



# eRHIC e-A collider at BNL

Want to join ?

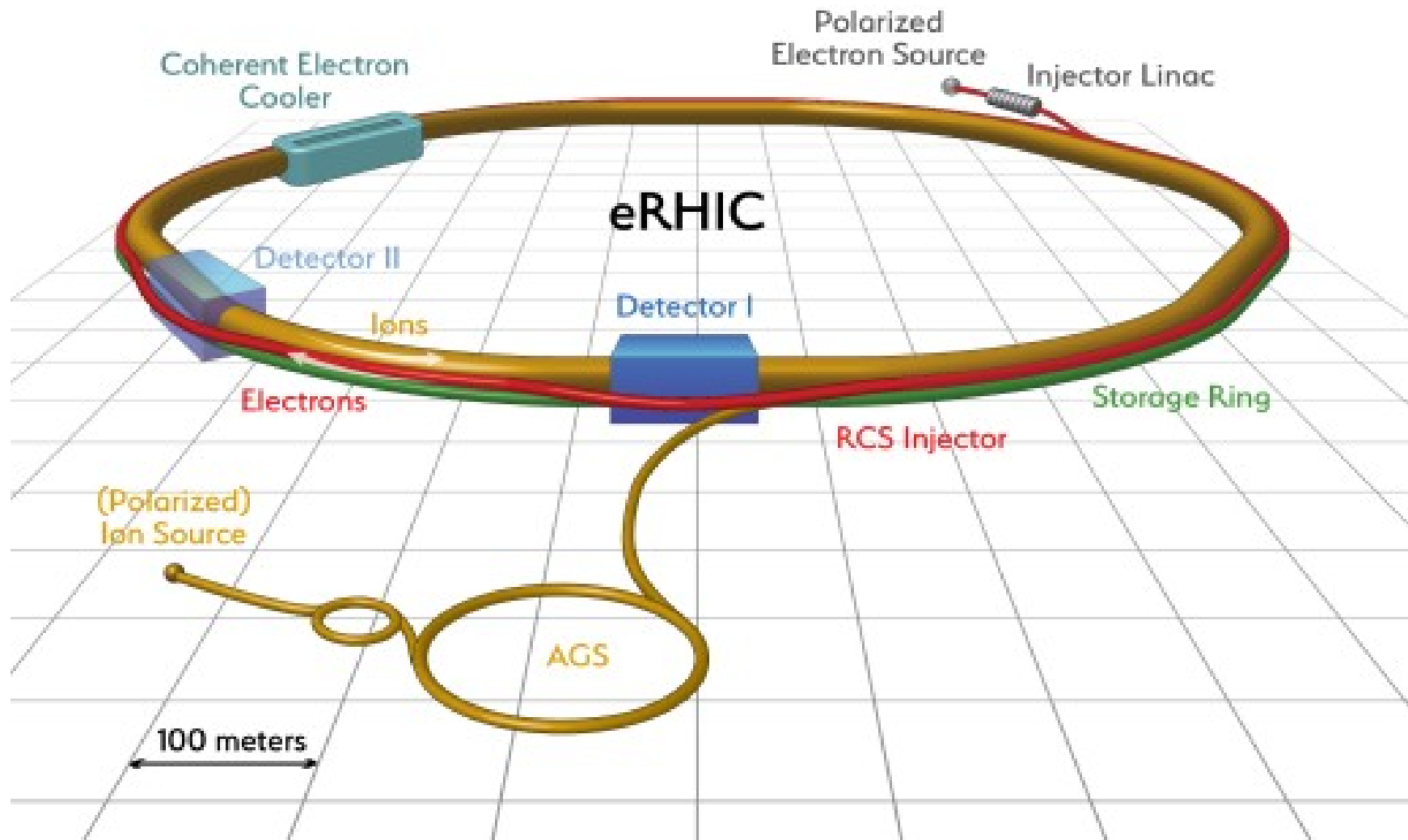

**And then... ?**

**Anything after 27 km long fridge,**

**100 m underground**

**LHC ?**



# The answer is “yes”

## Three-quarter century HEP projects:

CERN's  
FCC-ee + FCC hh collider  
Circumference 100 km.  
exe/125GeV, pxp/100TeV

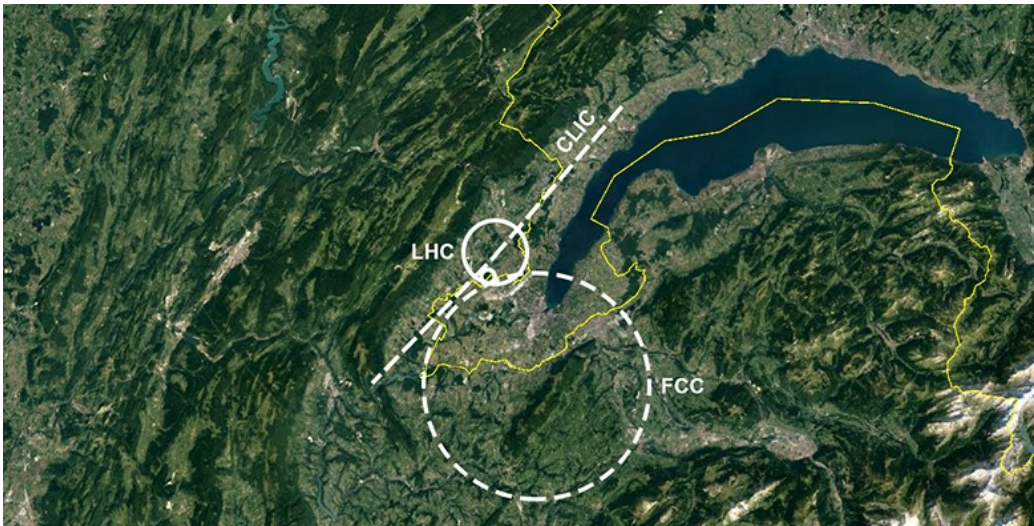
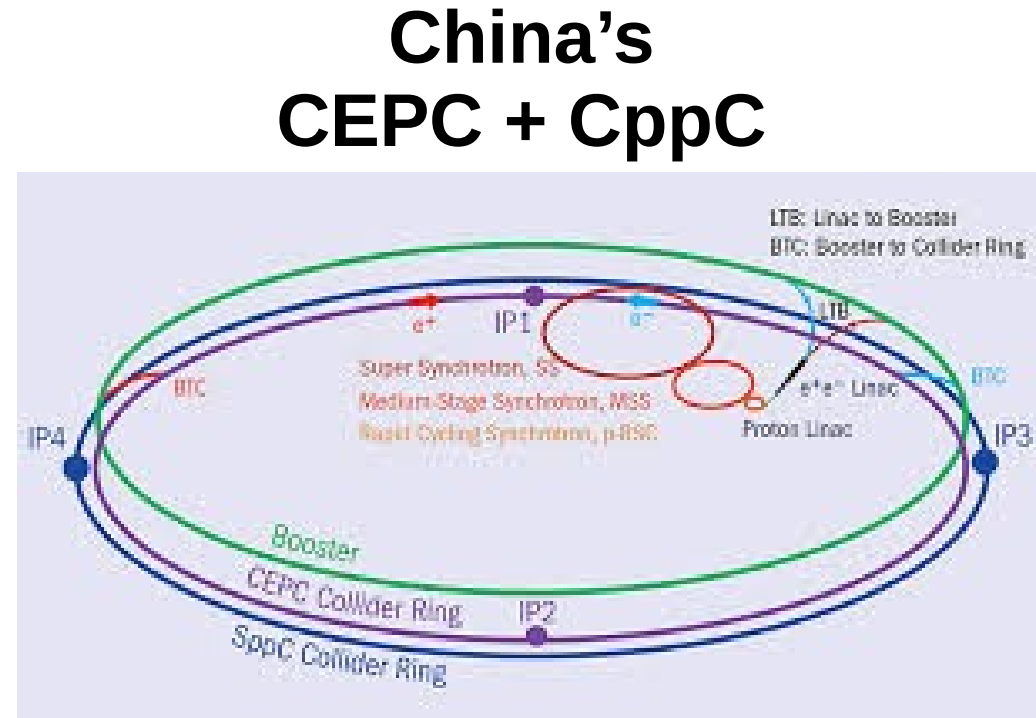

# THANK YOU FOR YOUR ATTENTION

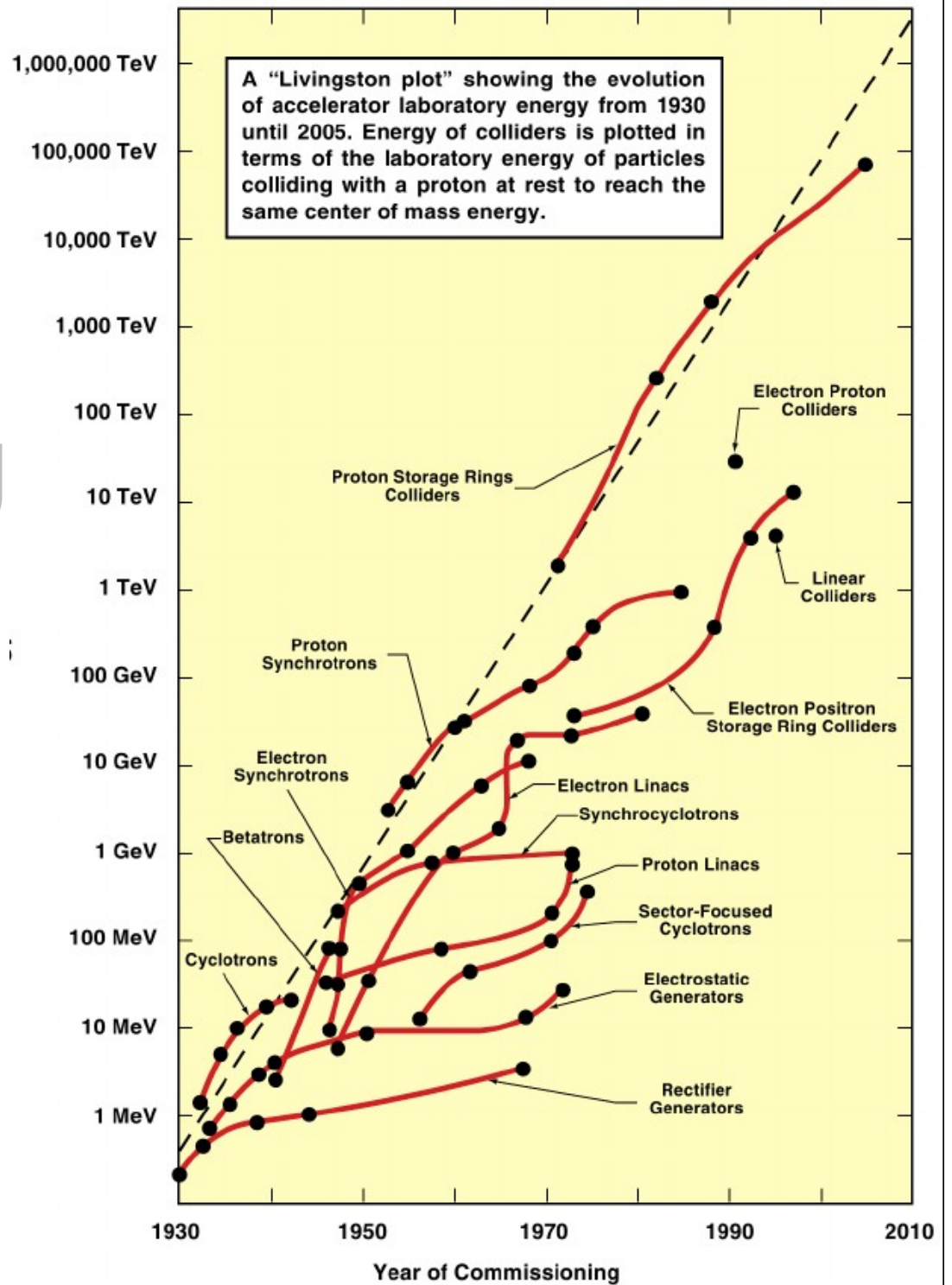



# BACKUP SLIDES

# **ELECTROSTATIC ACCELERATORS**



Electrons (<100 keV) were the first projectiles [PJB] – Wimshurst type machines

- 1895 Lenard, e scattering on gas
- 1913 Franck and Hertz, excite electron shells by e bombardment

## 2 Prehistory

Natural (several MeV)

$\alpha$  particles were the first projectiles atoms

- 1900s Rutherford figures out that  $\alpha$ -particles are He nuclei.
- 1910 Rutherford and Madsen first smash atoms with  $\alpha$ -particles to gain insight in the atom structure from scattering patterns. They detect the presence of a nucleus.
- 1910s Rutherford and Madsen kick out protons from various elements by that very method
- 1930s Bothe and Becker, Joliot-Curie family, Chadwick knock out neutrons by bombarding Be nuclei :  $\alpha + {}^9\text{Be} \rightarrow {}^{13}\text{C} + n$ .

Chadwick convincingly shows that the emerging particles were neutrons.

### Cosmic rays

- 1900s, Presence of radiation observed, using electroscopes and electrometers, even away from any radioactive source.
- 1932 Anderson discovers positron, predicted by Dirac
- 1937 Anderson and Neddermeyer discover a particle with  $220\times$  the electron mass, from cosmic ray snaps: the muon
- 1947 Lattes, Occhialini, Powell discover charged pions (today's  $\bar{u}d$  and  $\bar{d}u$  quark pairs)
- 1940s Discoveries of strange particles:  $K^\pm, K_0, \Lambda, \Sigma^+$  (hadrons with one strange quark)

• The difficulty of these paths was that one had no control over the projectiles, their energies, their rate was rather scarce

- 1928: Gamov predicts tunneling: few 100keV H+ would suffice to penetrate nucleus
- Hence the interest of accelerators for creating new particles. Milliampers of MeV particles from accelerators is equivalent to thousand-Curie radioactivity.

- 1928: Cockcroft and Walton start designing an 800 keV H+ generator, encouraged by Rutherford.

### 3 Electrostatic accelerators

#### A BRIEF INTRODUCTION

- Creating strong electrostatic potential : simplest and most obvious method.  
This is a way to communicate energy to charged particles, by virtue of

$$\vec{F} = -q \text{grad}V, \quad W = qV$$

- There was a broad context of development of high voltage generators :
  - Whimshurst wheel (1880s - 10s kV, few tens  $\mu\text{Amp}$ ), Marx generator (1924 - a variant of a voltage-multiplier), Tesla coil (induction high voltage) ...
  - Two methods succeeded : Crockcroft-Walton voltage multiplier, Van de Graaff electrostatic generator.
- Limitation on potential achievable for particle acceleration resides in
  - ohmic losses in apparatus structure - proportional to potential
  - current from ionized gas - limited by saturation
  - corona discharge - the major cause





John Douglas Cockcroft  
Ernest Walton



1951

Pioneer work on the transmutation of atomic nuclei by artificially accelerated atomic particles.

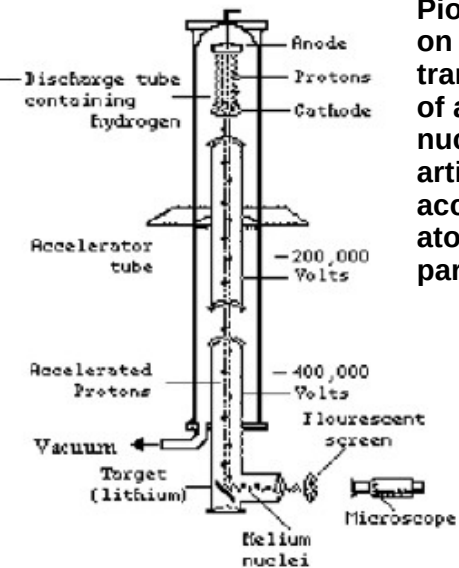

A scheme of C-W's 2-gap accelerator column.  
Potential for Li decay experiment was  $\sim 700$  kV

## Cockcroft-Walton (1/3)

- A particular type of “voltage multiplier” (also known as “Greinacher multiplier”, earlier proposed by Heinrich Greinacher, Swiss, 1919), coupled to accelerating gaps, at Cavendish Lab., 1932 :
- interest of *accelerator method* proven by allowing first artificial nuclear transmutation,  ${}^7_3\text{Li} + p \rightarrow 2 \times \alpha + 17 \text{ MeV}$
- Only 20 years later, 1951, did they get the Nobel prize “for their pioneer work on the transmutation of atomic nuclei by artificially accelerated atomic particles”.

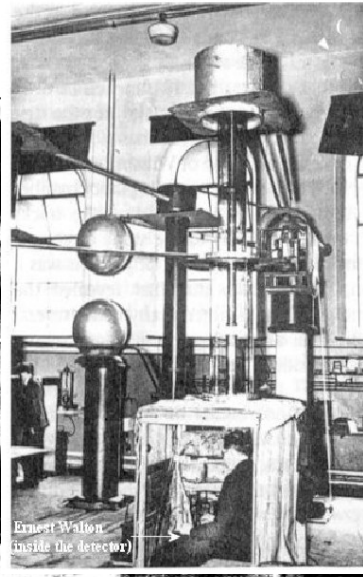

Ernest Walton (inside the detector)

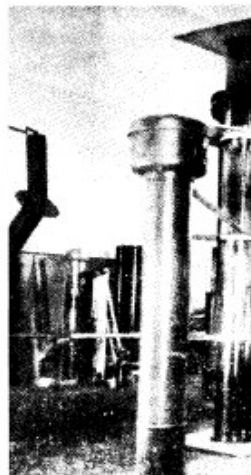
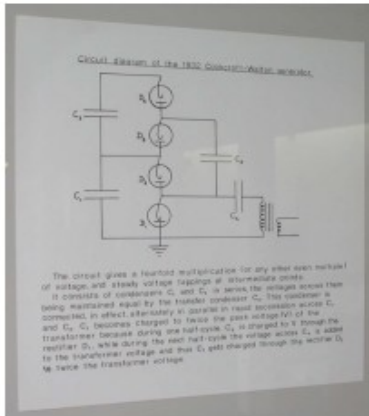

Voltage-multiplier circuitry and installation.

$\approx 700$  kV from a 200 kV transformer were obtained,  
 $\sim 10 \mu\text{A}$  proton beam.

Penetration probability  $1.8 \cdot 10^{-7}$  at 700 kV  $\xrightarrow{10 \mu\text{A}}$   $10^7$  events/s.

## Cockcroft-Walton (2/3), principle

The figure below shows principle assembly of (modern-style) Cockcroft-Walton voltage multiplier driven by AC voltage supply (left) and typical multi-electrode accelerator column (right).

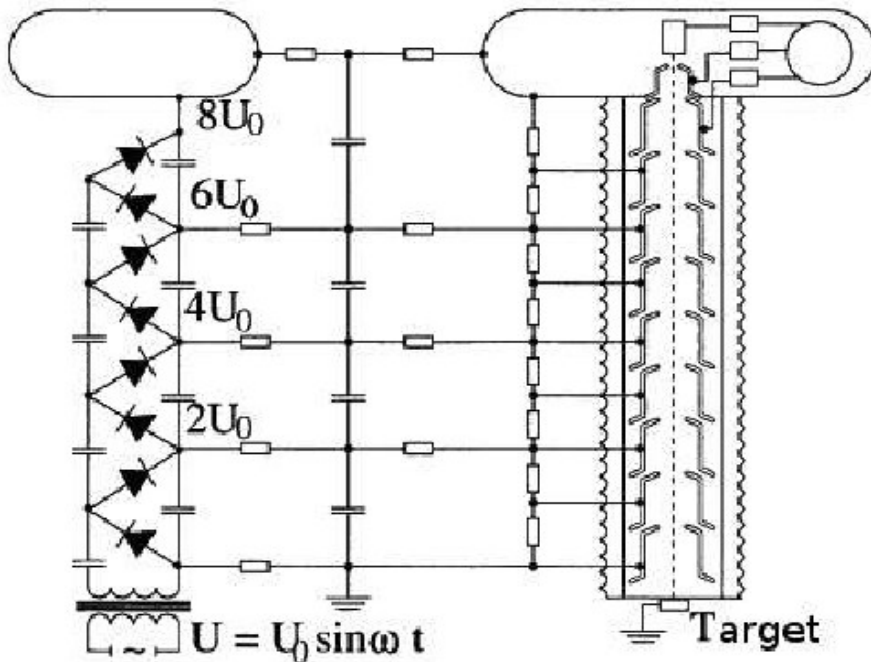

Nowadays technologies allow up to  $U_{total} \sim 5$  MVolts, several tens mA DC (>100 kW beam).

Principles :

The maximum voltage is  $2 \times n \times U_0$ , plus a correction for current induced loss :

$$U_{total} = 2 \times n \times U_0 - \frac{2\pi I}{\omega C} \times f(n)$$

$C$  = value of a capacitor

$n$  = number of stages

$I$  = ohmic loss + beam

$f \sim n^3$  polynomial dependence  $\Rightarrow$  limitation on  $n$  : voltage drop with  $I$  grows fast with the number of stages

It shows that large  $C$  and large  $\omega$  reduce the effect of  $I$  on  $U_{total}$ .

Accelerator application : stability  $\frac{\delta U_{tot}}{U_{tot}} \approx \frac{2\pi n^3}{RC\omega} \approx \text{few}\%$

Focusing : "cylindrical lens" principles

**Exercise :**

Take impedance  $R \sim G\Omega$ , capacity  $C \sim nF$ .

What is the order of magnitude of generator frequency  $\omega/2\pi$  for  $\frac{\delta U_{tot}}{U_{tot}} \sim 1\%$ .

**Response : kHz range.**



## Cockcroft-Walton (3/3)

- Cockcroft-Walton voltage multiplier is one amongst various other types of voltage multipliers
- A technique convenient in accelerator installations, still in use today in number of laboratories, at the front end of the injection chain.

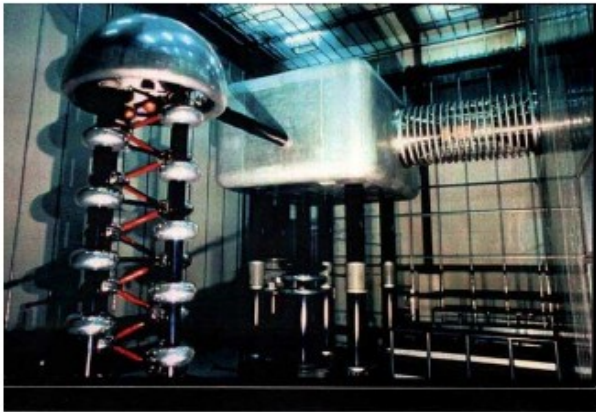

A modern version :  
the 810 kV, 30 mA Cockcroft-Walton  
injector at the PSI Mega-Watt cyclotron,  
using a voltage multiplier.

Exercise : value of  $n$  ,  $U_0$  ?

Resp. :  $n=5$  ,  $U_0 \sim 80$  kV



Some more easy kVs...

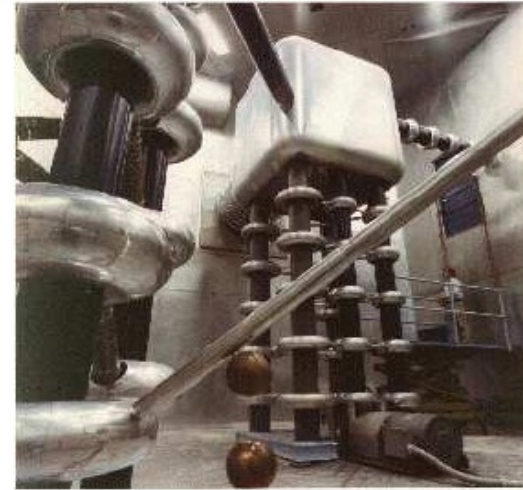

FermiLab injector (source, C-W and transfer lines  
are doubled for minimal down-time).  
H-, 20 keV DC beam, accelerated to 750 keV prior  
to bunching and injection into a DTL.

And a trend, replacement by RFQ :

*"[...] to reduce the maintenance requirements of the 750-keV pre-accelerator system, the replacement of the present Cockcroft-Walton accelerators with a single RFQ accelerator is proposed."*  
(December 2008)

# Van de Graaff (1/2)

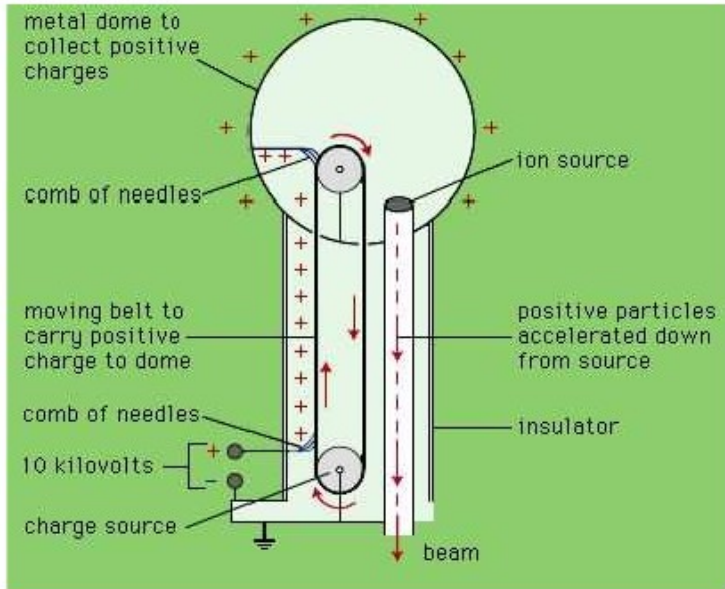

Van de Graaff electrostatic generator, principle : + or - charges, as brought by the insulating belt, are stored at the outer surface of the bulbe. Sharp points of combs are close to, but not touching, the belt, charges are transported from and to the belt by corona effect. Potential is used to accelerate particles.

- The Van de Graaff generator is simple, easy to regulate, capable of producing high voltages and therefore high accelerations of electrons or ions (compared at that time to Cockcroft-Walton).
- It is preferred when low ripple (low energy spread) is important at megavolt potentials.
- Intensity limited to ~mA.
- Effects limiting maximum achievable voltage are, size !, leakage, insulation, shape of electrodes...



In the company of its developer...

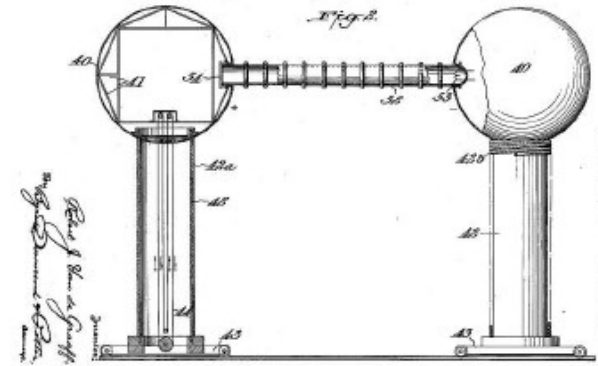

Patent figure, Dec. 1931.

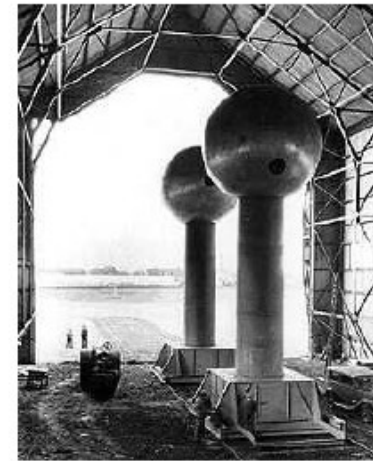

A 2 x 3.5 MV specimen, 1933.



## Van de Graaff (2/2), Tandem

- There are nowadays hundreds of Van de Graaff accelerators over the world.
- Often under the form of “tandem Van de Graaff” : doubles available energy, and gas pressurised (isolating gas SF6, freon, several  $10^5$ Pa) : limit corona effects, reduce size, source and target at ground potential.

In the “Pelletron” (1960’s), a pellet chain replaces the belt and induction devices replace the needle combs (yields better stability, reliability...)

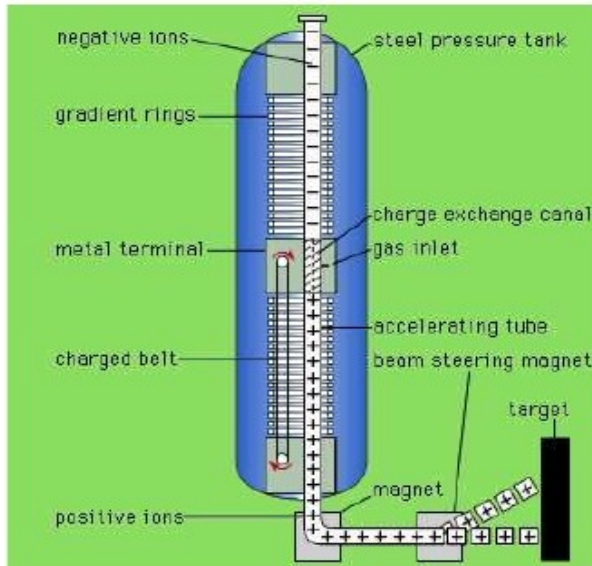

Two-stage - “tandem” - pressurized Van de Graaff.



One of the two (face-to-face) stages of the 15 MV Tandem-Van de Graaff at BNL. Can accelerate 40 different types of ions.



The tandem Van de Graaff at Western Michigan University, used for basic research, student training...



20 MV tandem VdG at Tandar Lab., Argentina (above), a smaller ancestor in earlier times (below).

