

An introduction to beam optics

- We will address in this lecture the theory of the guiding and focusing of charged particles in accelerator structures. We will start discussing the methods of “Beam Optics” by introducing the basic tools needed in that domain :

- (i) We will investigate how particle motion in electrostatic fields and magnetostatic fields is governed by the fundamental laws of dynamics

- and how approximations of these into convenient mathematical tools will make our lives sometimes simpler

- (ii) We will introduce the basic “optical elements” used in accelerator structures as beam lines, circular accelerators, spectrometers, etc., which ensure guiding, focusing and other beam manipulations.

- Then, we will “visit” : discuss, understand, some typical examples of such optical assemblies.

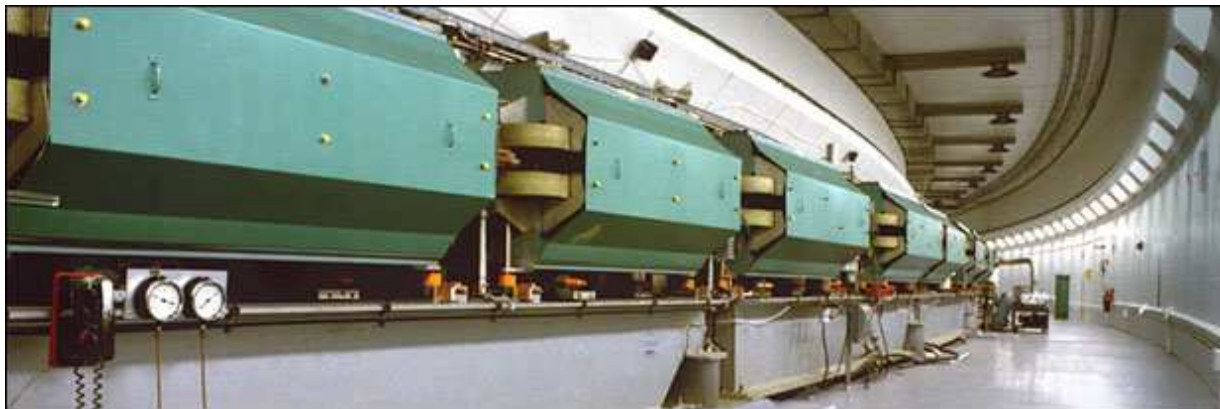

Contents

1	Some elementary principles of beam optics	3
2	Motion of a charged particle in electric or magnetic fields	11
3	An introduction to guiding and focusing optical elements	40
3.1	Magnetic quadrupole	41
3.2	Electrostatic quadrupole	60
3.3	Relative efficiency of magnetic and electrostatic quadrupoles	63
3.4	Skew quadrupole	64
3.5	Non-linear magnetic multipoles	65
3.6	Dipole electromagnet - “bending magnet”	71
3.7	Electrostatic cylindrical lenses	83
3.8	Electrostatic prism	92
3.9	Combined $\vec{E} + \vec{B}$ optical elements	93
3.10	Combined $\vec{E} + \vec{B}$ optical elements	94
4	Treatment of charged particle motion in optical ensembles	95
4.1	General development of mid-plane symmetry fields	95
5	Notions of phase space, emittance	109
5.1	Phase space	109
5.2	The beam matrix, beam transport	119
6	A tour of optical systems	129
6.1	Energy loss spectrometer	129
6.2	A high resolution mass separator (HRS)	137
7	Solutions to the exercises	142

1 Some elementary principles of beam optics

- **Optical systems in the Gauss approximation are assemblies of usually simple optical elements, within which rays - “particle trajectories” in the case of charged particles optics - are governed by generally simple geometrical rules.**
- **Beam optics very often deal with a limited of optical element species as, for instance :**

Ex. 1 - Drift space :

This is the simplest optical element one can imagine : a portion of space where the particle drifts freely, subject to no external force. The particle follows a straight line.

(Note that, in doing that assumption, we neglected the mutual interaction between particles, see “Space charge” lectures)

$$\begin{cases} x_f = x_i + L \tan(\theta) = x_i + x'_i L \\ x'_f = x'_i \end{cases}$$

$L = s_f - s_i$ and we have noted $x' = \frac{dx}{ds} = \tan \theta$.

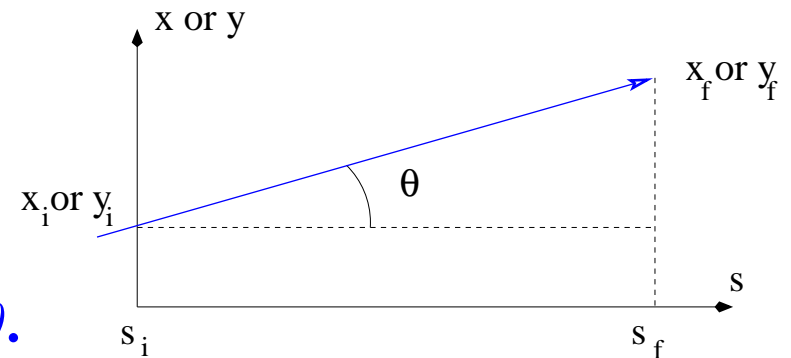

- **“Transverse coordinates” : we will note/use x, x', y, y' ,**
- **“Longitudinal coordinate” : s ,**
see “JUAS Nomenclature” leaflet as to the nomenclature.

The transport of the particle from s_i to s_f can be treated using a “transfer matrix”

“Matrix transport” allows to move the particle from an initial state (x_i, x'_i) to a final state (x_f, x'_f) :

$$\begin{Bmatrix} x \\ x' \end{Bmatrix}_f = \begin{bmatrix} 1 & L \\ 0 & 1 \end{bmatrix} \begin{Bmatrix} x \\ x' \end{Bmatrix}_i$$

$$M(s_f \leftarrow s_i) = \begin{bmatrix} 1 & L \\ 0 & 1 \end{bmatrix}$$

is the transfer matrix of the L -long drift.

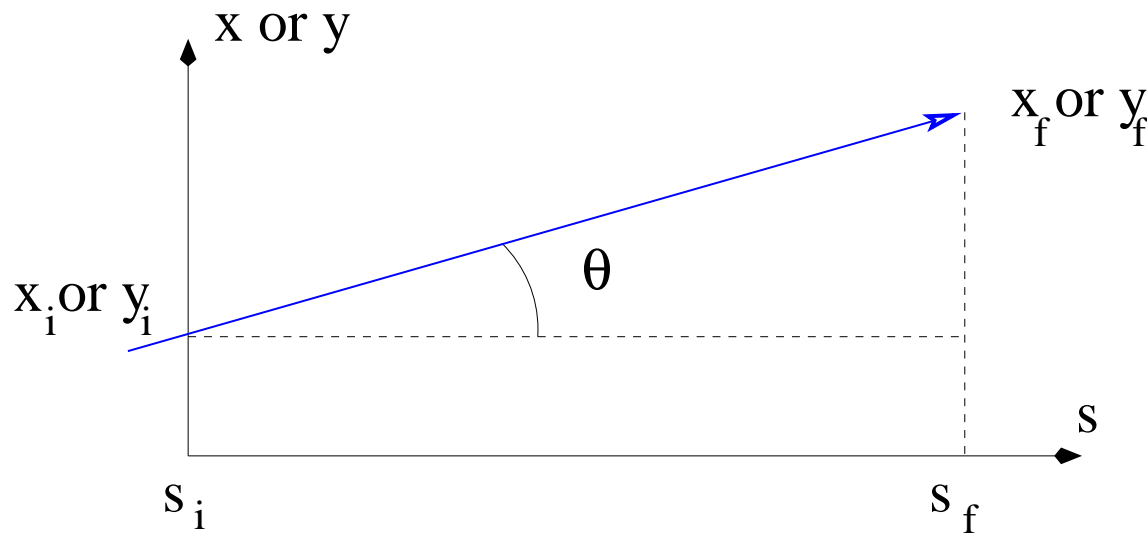

Ex. 2 - Focusing or defocusing lens, often treated in the thin lens approximation :

Defocusing lens

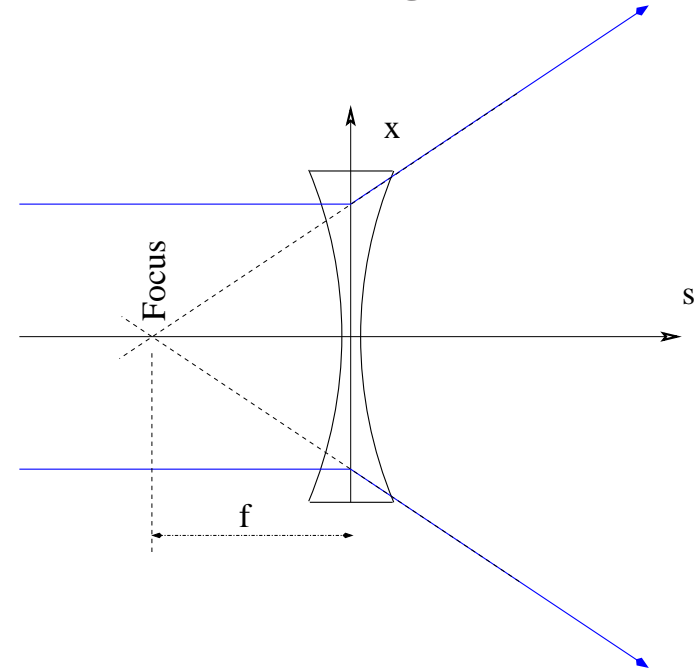
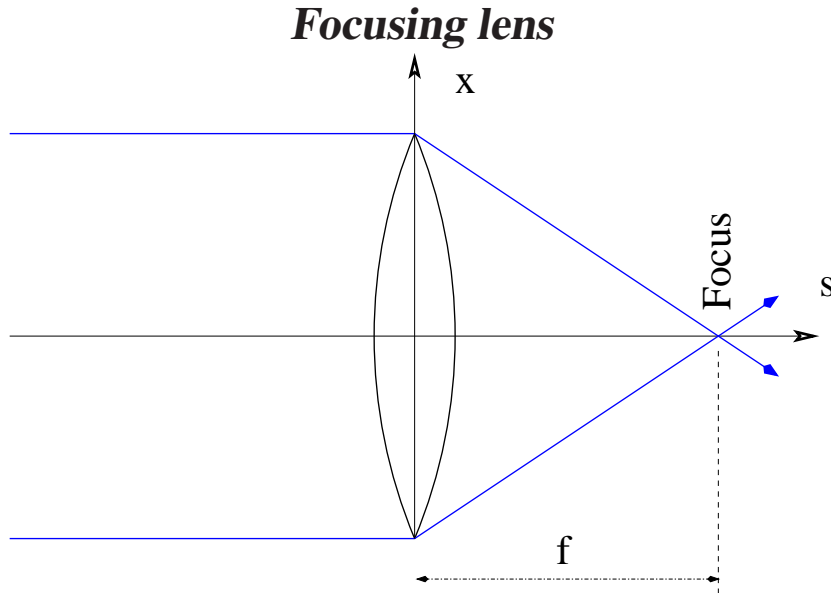

$$\begin{cases} x_f = x_i \\ x'_f - x'_i \propto x_i \end{cases} \rightarrow x'_f - x'_i = k x_i$$

What is k ?

Considering the focusing lens and a ray launched from the left, parallel to the optical axis ($x'_i = 0$),

one gets $x'_f = \tan(\theta) = -(x_f/|f|)$, f is the **focal distance**, $k = -1/|f|$.

In a general manner, given a non-zero incidence, x'_i , the lens causes a “kick”,

$$\Delta x' = x'_f - x'_i = \mp \frac{x_i}{|f|}, \quad (-) \text{ for a focusing lens, } (+) \text{ for a defocusing lens.}$$

Particle transport can be expressed in the matrix form,

$$\begin{Bmatrix} x \\ x' \end{Bmatrix}_f = \begin{bmatrix} 1 & 0 \\ -1/f & 1 \end{bmatrix} \begin{Bmatrix} x \\ x' \end{Bmatrix}_i$$

$$M(s_f \leftarrow s_i) = \begin{bmatrix} 1 & 0 \\ -1/f & 1 \end{bmatrix}$$

$f > 0$, **focusing lens**

$f < 0$, **defocusing lens**

is the transfer matrix of the thin lens.

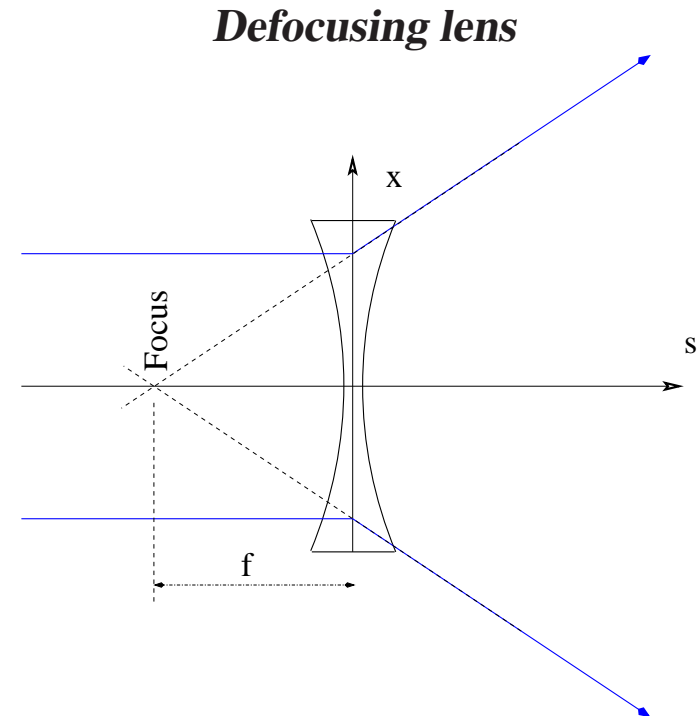
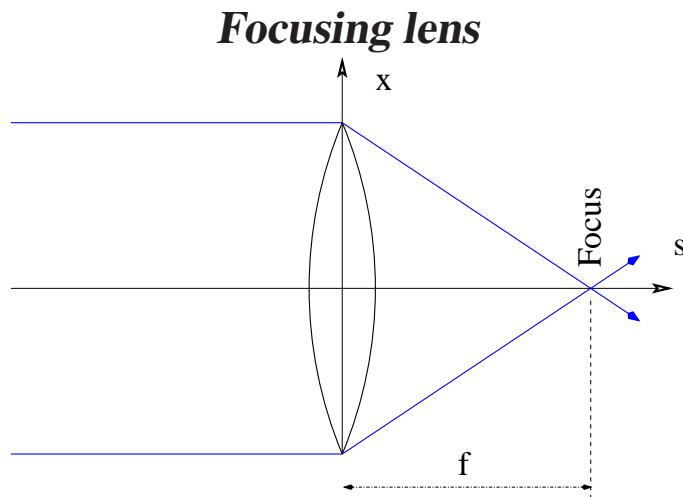

EXERCISE

**A basic brick in beam transport optical systems :
The “FD DOUBLET”**

Consider the following optical series :

First, a focusing lens with focal distance f ; next, a drift of length l ; next a defocusing lens with the same focal distance f .

1/ Calculate the transfer matrix, T , of that assembly.

2/ Verify that the determinant of T is 1. Why 1 ?

3/ What is the distance A from the defocusing lens to the focal point of the system ?

4/ At what condition linking f and l is the system globally converging ?

- **In a general manner, the design**

- **of beam transport lines,**

- **and of circular accelerators as well - including the largest ones !**

in first approximation only require elementary functions as parabola, sine, cosine, hyperbola, exponential.

- **The complexity of optical assemblies arises from the variety of these laws and of their combination :**

- a particle will follow arcs of circles, arcs of parabola, sine trajectories, “pseudo-sine” laws, etc.**

- **As a consequence, a very limited mathematical toolbox makes it is possible to deal with sometimes very complex optical assemblies.**

EXERCISE

Going through a first section, (A) , of an optical assembly, the transport writes

$$\begin{pmatrix} x \\ x' \end{pmatrix}_f = \begin{pmatrix} a & b \\ c & d \end{pmatrix} \begin{pmatrix} x \\ x' \end{pmatrix}_i$$

Going through the rest of the assembly, the optical system traversed, (\tilde{A}) , is just the symmetric of (A) .

1/ Express the transport matrix through (\tilde{A}) .

2/ Calculate the full matrix. What do you observe ?

EXERCISE

We consider an optical series, FLDL, with the two lenses distant l and tuned to the same focusing distance $|f|$.

1/ Calculate the transfer matrix of this FODO cell (use earlier exercise, complete with a drift).

Let us introduce a particular notation for T , namely,

$$T_\mu = I \cos \mu, + J \sin \mu$$

with I the identity matrix and $J = \sqrt{-I} = \begin{pmatrix} \alpha & \beta \\ -\gamma & -\alpha \end{pmatrix}$

2/ Make sure $J^2 = -I$

3/ What is the condition linking α, β, γ so that the determinant of T_μ is 1 ?

4/ Considering the trace of T_μ in the latter notation, and by comparison with the trace of T obtained from 1/, what is the condition linking f and l such that the notation $T_\mu = I \cos \mu, + J \sin \mu$ be valid ?

5/ Show that $(T_\mu)^N = T_\mu(N\mu)$

6/ What does 5/ mean in terms of multi-turn particle transport in a circular accelerator ?

2 Motion of a charged particle in electric or magnetic fields

- Optical rays are deflected, reflected, using dioptric and/or catadioptric systems,
- charged particles are deflected, reflected, *and accelerated too*,
 - using magnetic fields
 - electric fields
 - combinations of both,
 - either static or in addition, in some cases, varying in time.
- Prior to looking in a detailed way at the optical elements proper to charged particle optics, we will first review the basis of the motion of charged particles in magnetic and electric fields.

Notions of dynamics

- The force that acts on a charged particle,

is the Lorentz force : $\vec{F} = q(\vec{E} + \vec{v} \times \vec{B})$

q : charge of the particle (Coulomb, C)

\vec{v} : velocity of the particle (m/s)

\vec{E} : electric field, in Volt/m (V/m)

\vec{B} : magnetic field, in Tesla (T)

- The **ELECTRIC FORCE**, $\vec{F} = q\vec{E}$:

(A) An electric force can be of electrostatic origin :

- No varying fields in that hypothesis, i.e., $\frac{\partial \vec{B}}{\partial t} = 0$ and as a consequence (Maxwell) : $\text{curl } \vec{E} = -\frac{\partial \vec{B}}{\partial t} = 0$

The static field \vec{E} derives from a potential, $\vec{E} = -\text{grad}V(M)$, since $\text{curl}(\text{grad}()) = 0$, the change of V in space is the cause of the existence of \vec{E}

- The electrostatic force $\vec{F} = q\vec{E}$ works :

In the hypothesis where V does not depend on time t , then between points A and B the work by \vec{F} is

$$\mathcal{T} = \int_A^B \vec{F} \cdot d\vec{s} = -q \int_A^B \text{grad}V d\vec{s} = -qV|_A^B = q(V_A - V_B)$$

The work by \vec{F} only depends on initial and final positions A and B, it does not depend on the path followed from A to B.

In particular, on a closed path, $\mathcal{T} = \oint \vec{F} \cdot d\vec{s} = q \underbrace{\int \int \text{curl} \vec{E} d\tau}_{\text{Stoke's theorem}} = 0$

by virtue of $\text{curl grad} \equiv 0$

This has an important consequence :

In a circular accelerator, the beam follows a closed path, thus it is not possible to accelerate particles by means of an electrostatic field, the energy gained from possible electrostatic gaps located between A and B has to be lost (somewhere) in the path from B to A.

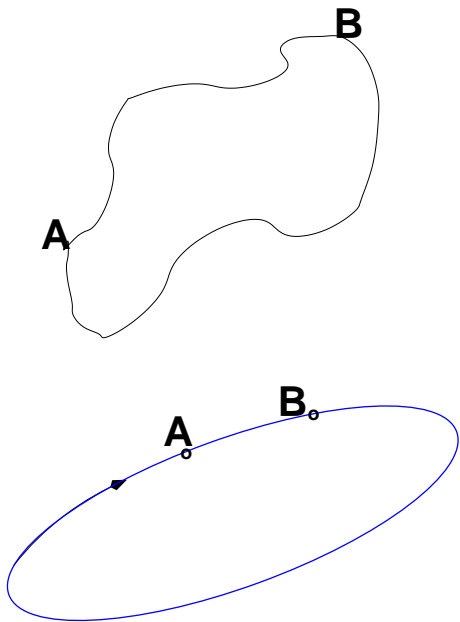

(B) An electrostatic force can be of inductive origin :

The electrostatic field takes its origin in a time varying vector potential, $\vec{E} = -\frac{\partial \vec{A}}{\partial t}$

This stems from Maxwell's equations : \vec{A} , \vec{B} , \vec{E} satisfy $\vec{B} = \text{curl } \vec{A}$, and so $\text{curl } \vec{E} = -\text{curl } \frac{\partial \vec{A}}{\partial t} = -\frac{\partial \text{curl } \vec{A}}{\partial t} = -\frac{\partial \vec{B}}{\partial t}$.

The existence of \vec{E} arises from the time variation of a magnetic flux.

The work of an induction force over a closed path is not necessarily zero.

As a consequence it is possible to accelerate on a circular path using an inductive electric field.

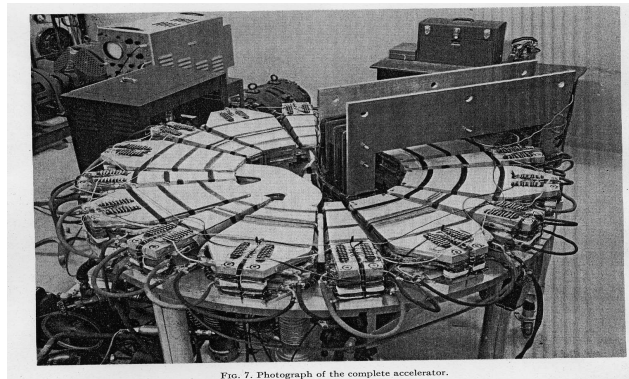

FIG. 7. Photograph of the complete accelerator.

Applications of induction acceleration can be found in :

Slow extraction from circular accelerators using a “betatron yoke”

Induction linacs, for production of high power beams,

Acceleration of muons in the neutrino factory,

“Long bunch” induction acceleration in a synchrotron at KEK PS.

- **The MAGNETIC FORCE :**

- **A manifestation of the magnetic force is the Laplace force on an electrical circuit :**

$$\vec{F} = I d\vec{l} \times \vec{B}$$

- **Another manifestation is the force experienced by charged particle with velocity, \vec{v} :**

$$\vec{F} = q\vec{v} \times \vec{B} ,$$

Under the effect of \vec{F} the charged particle undergoes a deviation, its trajectory is curved.

- **A magnetic force does not work :**

$\vec{F} = q(\vec{v} \times \vec{B})$ entails that \vec{F} is orthogonal to $\vec{v} = d\vec{s}/dt$,
as a consequence, the elementary work $d\mathcal{T}$ over distance $d\vec{s}$ satisfies

$$d\mathcal{T} = \vec{F} \cdot d\vec{s} = \underbrace{\vec{F} \cdot \vec{v}}_{=0} dt \equiv 0$$

An important consequence : magnetic forces cannot change particle energy, they can only change the direction of the velocity vector, i.e., deviate particles.

Two rules that allow inferring how a moving charged particle is deviated by a magnetic field

Both rules yield the orientation of \vec{F} :

- $I\vec{dl}$, \vec{B} and \vec{F} , in that order, form a direct trihedron :

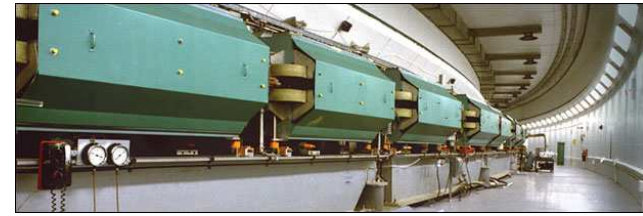

“Horizontally focusing dipole”
“Vertically defocusing dipole”

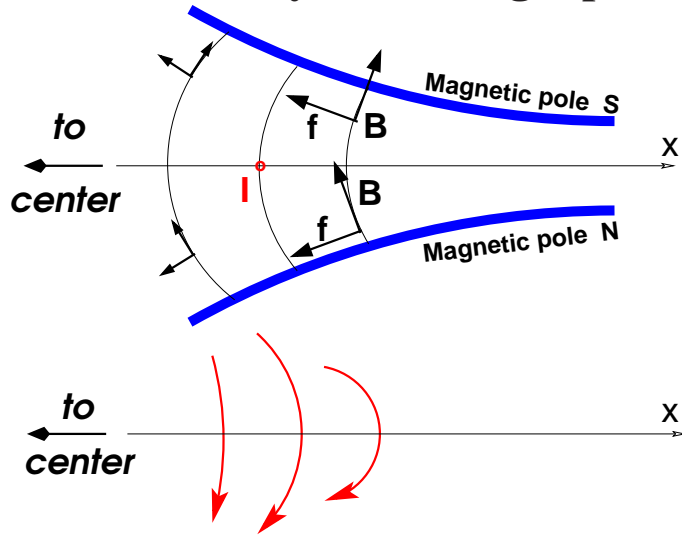

“Horizontally defocusing dipole”
“Vertically focusing dipole”

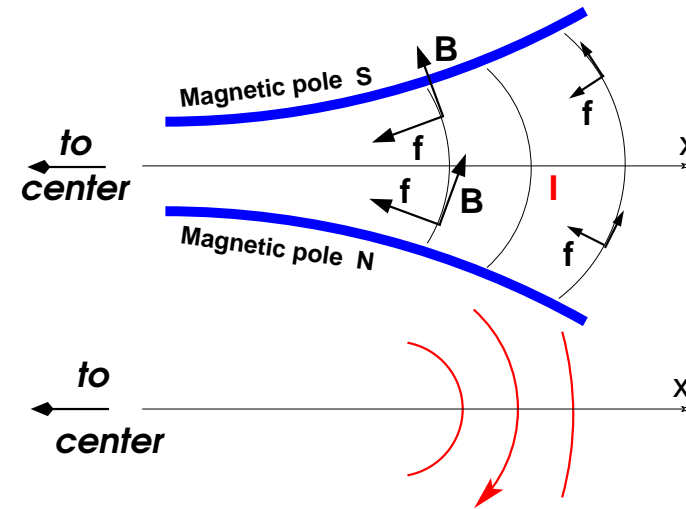

- Rule of the 3 right hand fingers :

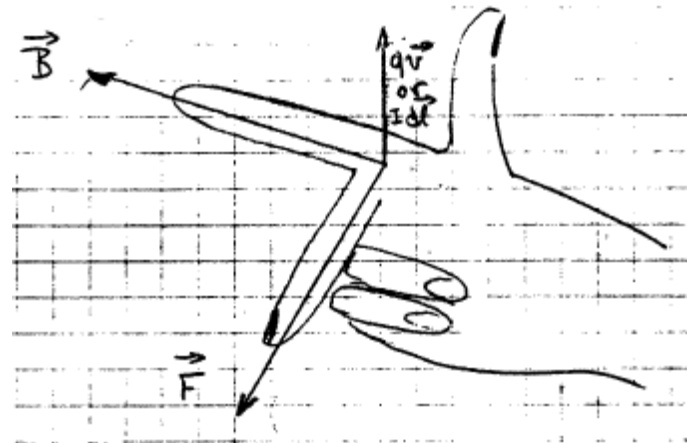

Discussing the fundamental equation of dynamics

Classical mechanics

$$m \frac{d\vec{v}}{dt} = \vec{F}, \text{ } m \text{ is constant}$$

Relativistic mechanics

$$\frac{dm\vec{v}}{dt} = \vec{F}, \quad m \text{ varies with } \vec{v}$$

These two similar forms of the differential equation that governs charged particle motion state that the motion is defined by a second order differential equation.

From a mathematical viewpoint, this has the consequence that the motion is considered as defined by

- the knowledge of the forces that intervene
- the knowledge of the initial state of the particle m : initial position and initial velocity in particular, *initial acceleration or past motion play no role*

Classical mechanics

$$\vec{F} = m \frac{d^2 \vec{M}}{dt^2} = m \frac{d\vec{v}}{dt}$$

which one can write

$$\vec{F} = \frac{dm\vec{v}}{dt} = \frac{d\vec{p}}{dt}$$

with $\vec{p} = m\vec{v}$ the impulse, or momentum

$$m = \text{constant} = m_0$$

Relativistic mechanics

$$\frac{dm\vec{v}}{dt} = \vec{F},$$

m varies with \vec{v}

with $\vec{p} = m\vec{v}$ the impulse, or momentum

$$m = m_0 / \sqrt{1 - \beta^2}, \text{ with } \beta = v/c$$

Work of the force during the time interval t_1 to t_2

Work of the force during the interval t_1 to t_2

The variation of the kinetic energy is equal to the work of the forces applied.

$$\begin{aligned}
\mathcal{T} &= \int_{t_1}^{t_2} \vec{F}(M, t) \cdot d\vec{M} \text{ with } d\vec{M} = \vec{v}(t) dt \\
&= \int_{t_1}^{t_2} m \frac{d\vec{v}}{dt} \cdot \vec{v} dt \\
&= \frac{m}{2} \int_{t_1}^{t_2} \frac{d}{dt} (v^2) dt \\
&= \frac{m}{2} \int_{t_1}^{t_2} d(v^2) = \frac{m}{2} \times [v^2]_{v_1}^{v_2} \\
&= W_2 - W_1
\end{aligned}$$

$W = \frac{1}{2}mv^2$ is the kinetic energy. No need to define the nature of the force (magnetostatic, inductive...)

The work by \vec{F} is

$$\mathcal{T} = W_2 - W_1 = \frac{1}{2}m(v_2^2 - v_1^2)$$

$v \ll c$
←

$$\begin{aligned}
\mathcal{T} &= \int_{t_1}^{t_2} \vec{F}(M, t) \cdot d\vec{M} \text{ with } d\vec{M} = \vec{v}(t) dt \\
&= \int_{t_1}^{t_2} \frac{d}{dt} \left\{ \frac{m_0 \vec{v}}{\sqrt{1 - v^2/c^2}} \right\} \cdot \vec{v} dt \\
&= \int_{t_1}^{t_2} \left(\frac{m_0 \vec{v} \cdot d\vec{v}}{\sqrt{1 - v^2/c^2}} + \frac{m_0 \frac{v^2}{c^2} \vec{v} \cdot d\vec{v}}{(1 - v^2/c^2)^{3/2}} \right) \\
&= \int_{t_1}^{t_2} \frac{m_0 c^2 \vec{v} \cdot d\vec{v}}{(1 - v^2/c^2)^{3/2} c^2} = \int_{t_1}^{t_2} d \left\{ \frac{m_0 c^2}{\sqrt{1 - v^2/c^2}} \right\} \\
&= \int_{t_1}^{t_2} d(mc^2) = (m_2 - m_1)c^2
\end{aligned}$$

An energy is associated with the mass m ,
 $E = mc^2$,
hence a “rest energy” $E_0 = m_0c^2$.

The kinetic energy is defined by $W = E - E_0$

The work by \vec{F} is $\mathcal{T} = E_2 - E_1 = W_2 - W_1$

EXERCISE**Show that**

$$\mathcal{T}_{12} = W_2 - W_1 = (m_2 - m_1)c^2 \xrightarrow{v \ll c} \frac{1}{2}m_0(v_2^2 - v_1^2)$$

Deviation of a charged particle in a uniform electric field

- The Lorentz force equation : $\vec{F} = q(\vec{E} + \vec{v} \times \vec{B})$ is reduced to

$$\boxed{\vec{F} = q\vec{E}}$$

We simplify the problem by taking \vec{p}_0 orthogonal to \vec{E} .

We simplify the mathematics (without loss of generality) by taking $\vec{E} // (x)$.

and, at t_0 : $\vec{p}_0 // (s)$

Thus : $\frac{d\vec{p}}{dt} = q\vec{E} \Rightarrow$

$$\left| \begin{array}{l} \frac{d\vec{p}_s}{dt} = 0 \\ \frac{d\vec{p}_x}{dt} = q E_x \\ \frac{d\vec{p}_y}{dt} = 0 \end{array} \right. \quad \text{hence, by integration} \quad \left| \begin{array}{l} \vec{p}_s = p_{s0} \\ \vec{p}_x = qE_x t + p_{x0} = qE_x t \\ \vec{p}_y = p_{y0} = 0 \end{array} \right.$$

We consider the usual frame (s, x, y) .
We take \vec{E} oriented parallel to (x) .

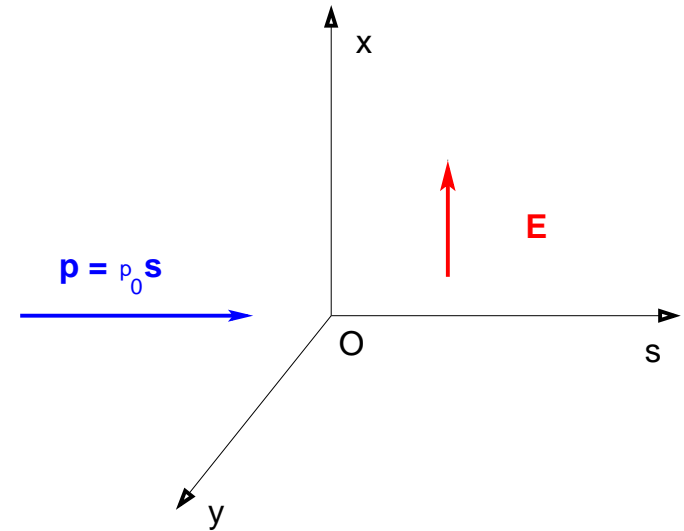

Integration of these equations of motion is not a simple task :

Let's first introduce, $\vec{p} = m\vec{v}$

$$\text{with } m = \frac{m_0}{\sqrt{1 - \beta^2}} = \frac{m_0}{\sqrt{1 - \frac{v^2}{c^2}}} = \frac{m_0}{\sqrt{1 - \frac{v_s^2 + v_x^2 + v_y^2}{c^2}}}$$

The integration is complicated by the entangling of the variables, s, x, y : in any equation all three

$$\frac{ds}{dt}, \frac{dx}{dt}, \frac{dy}{dt}$$

appear.

Two steps allow removing this difficulty :

a/ The energy satisfies $E^2 = E_0^2 + p^2 c^2 = (m_0 c^2)^2 + p^2 c^2$

with $E_0 = m_0 c^2$ the rest energy

and with p the momentum, $p^2 = p_s^2 + p_x^2 + p_y^2 = p_{s0}^2 + (qE_x t)^2$

yielding the time dependence, $E^2(t) = E_0^2 + p_{s0}^2 c^2 + (qE_x t)^2 c^2$

and $E^2(t) = E_i^2 + (qE_x t)^2 c^2$, with E_i the total energy at $t = 0$

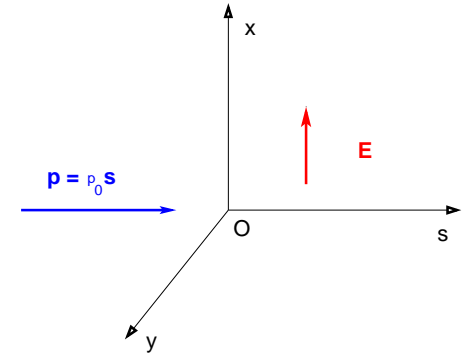

b/ $\vec{p} = m\vec{v}$ can be written $\vec{v} = \frac{1}{m}\vec{p} = \frac{c^2}{E}\vec{p}$,

given that E and \vec{p} are known at all time (\vec{p} results from the first integration, above)

One thus knows the velocity at all time :

$$\left| \begin{array}{l} \frac{ds}{dt} \equiv v_s = \frac{p_{s0} c^2}{\sqrt{E_i^2 + (qE_x ct)^2}} \quad (1) \\ \frac{dx}{dt} \equiv v_x = \frac{qE_x t c^2}{\sqrt{E_i^2 + (qE_x ct)^2}} \quad (2) \\ \frac{dy}{dt} \equiv v_y = 0 \quad (3) \end{array} \right.$$

Note an unexpected property : the equation (1) above tells that the longitudinal velocity v_s decreases with time $t \Rightarrow$ a transverse acceleration has the effect of decelerating longitudinally !

On the other hand v_x increases with time, yet with a limit : **which limit ?**

- **Slope of the trajectory**

At this step, we can calculate the slope of the trajectory.

As a matter of fact, the study of particle motion, and the design of accelerators and beam lines requires the knowledge of the slope of trajectories, $\frac{dx}{ds}$, $\frac{dy}{ds}$.

$$\frac{dx}{ds} = \frac{\frac{dx}{dt}}{\frac{ds}{dt}} = \frac{\frac{qE_x t c^2}{\sqrt{E_i^2 + (qE_x c t)^2}}}{\frac{p_{s0} c^2}{\sqrt{E_i^2 + (qE_x c t)^2}}} = \frac{qE_x t c^2}{p_{s0} c^2} = C^{ste} \times t$$

The slope increases proportionally with time t .

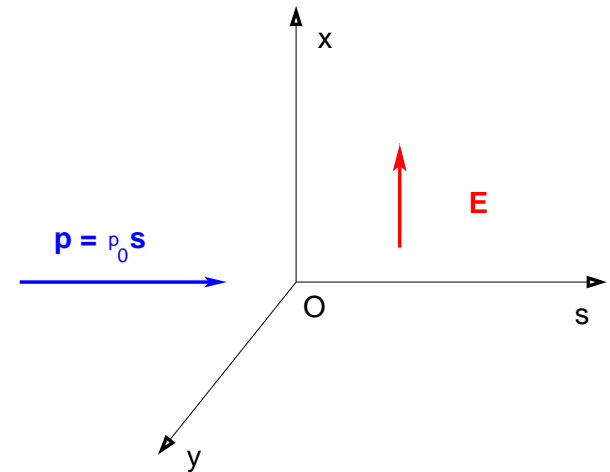

EXERCISE

$$v_x = \frac{qE_x t c^2}{\sqrt{E_i^2 + (qE_x c t)^2}}$$

Show that $v_x \xrightarrow{t \rightarrow \infty} \pm c$

- Integration of the velocity equations

We start from the expression derived earlier for v_s , v_x , v_y and proceed further :

$$\left\{ \begin{array}{l} ds = v_s dt = \frac{p_{s0} c^2 dt}{\sqrt{E_i^2 + (qE_x ct)^2}} = \frac{p_{s0} c}{qE_x} \frac{dt}{\sqrt{a^2 + t^2}}, \quad \text{with } a = \frac{E_i}{qE_x c} \\ dx = v_x dt = c \frac{t dt}{\sqrt{a^2 + t^2}} \\ dy = v_y dt = 0 \end{array} \right. \quad (3)$$

In order to simplify further the equations, we assume $s = x = y = 0$ at time $t = 0$,

On the other hand, one has

$$\int \frac{dt}{\sqrt{a^2 + t^2}} = A \sinh \frac{t}{a}, \quad \int \frac{t dt}{\sqrt{a^2 + t^2}} = \sqrt{a^2 + t^2}$$

so that

$$\left\{ \begin{array}{l} s = \frac{p_{s0} c}{qE_x} \int_0^t \frac{dt}{\sqrt{a^2 + t^2}} = \frac{p_{s0} c}{qE_x} \int_0^t \left[A \sinh \frac{t}{a} \right] = \frac{p_{s0} c}{qE_x} A \sinh \frac{qE_x ct}{E_i} \\ x = c \int_0^t \frac{t dt}{\sqrt{a^2 + t^2}} = c \left[\sqrt{a^2 + t^2} \right]_0^t = c \left[\sqrt{a^2 + t^2} - a \right] = \frac{1}{qE_x} \left[\sqrt{E_i^2 + (qE_x ct)^2} - E_i \right] \\ y = 0 \quad \text{(the trajectory stays in the (Oxs) plane !)} \end{array} \right.$$

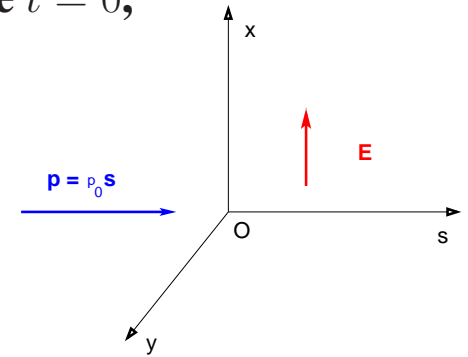

- Trajectory

Its equation can be obtained by removing time between the equations for s and for x :

from our earlier $s = \frac{p_{s0}c}{qE_x} A \sinh \frac{qE_x ct}{E_i}$ one gets

$$qE_x ct = E_i \sinh \frac{qE_x s}{p_{s0}c}$$

which, given the earlier $x = \frac{1}{qE_x} \left[\sqrt{E_i^2 + (qE_x ct)^2} - E_i \right]$ thus yields

$$x = \frac{1}{qE_x} \left[\sqrt{E_i^2 + E_i^2 \sinh^2 \frac{qE_x s}{p_{s0}c}} - E_i \right] = \frac{E_i}{qE_x} \left[\sqrt{1 + \sinh^2 \frac{qE_x s}{p_{s0}c}} - 1 \right]$$

Using in addition $\cosh^2 u + \sinh^2 u = 1$, one then gets

$$x = \frac{E_i}{qE_x} \left(\cosh \frac{qE_x s}{p_{s0}c} - 1 \right)$$

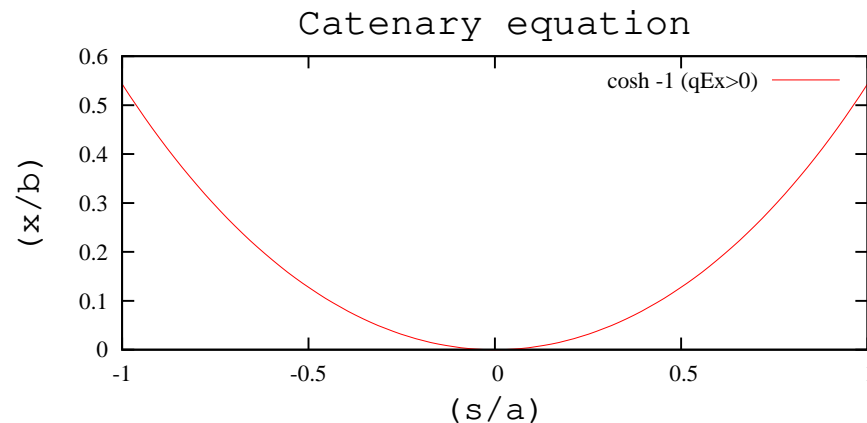

EXERCISE

Show that in the “classical mechanics” case, *id est*, $v \ll c$, the trajectory is a parabola.

Hint : derive the equation of that parabola from the “relativistic mechanics” one,

$$x = \frac{E_i}{qE_x} \left(\cosh \frac{qE_x s}{p_{s0}c} - 1 \right)$$

Deviation of a charged particle in a uniform magnetic field

- The Lorentz force equation : $\vec{F} = q(\vec{E} + \vec{v} \times \vec{B})$ is reduced to $\boxed{\vec{F} = q \vec{v} \times \vec{B}}$

- Remember that the fundamental relation of dynamics yields,

$$m_0 \frac{d\vec{v}}{dt} = q \vec{v} \times \vec{B} \text{ in “classical mechanics” } (v \ll c).$$

- $\frac{dm\vec{v}}{dt} = q \vec{v} \times \vec{B}$ in “relativistic mechanics” (when v is no longer negligible compared to velocity of light).

- Remember also that \vec{B} does not work, it cannot induce a change in energy, the velocity and the mass are constant :

Lorentz relativistic factor $\gamma = 1/\sqrt{1 - v^2/c^2} = \text{constant}$.

The relativistic mass $m = \gamma m_0$ is constant.

As a consequence, both classical and relativistic equations can be written under the form

$$\boxed{m \frac{d\vec{v}}{dt} = q \vec{v} \times \vec{B}}$$

- Only basic considerations will be introduced in the present chapter, we will have many occasions to sophisticate things further later during the lecture :
so, for the moment, we simplify the problem by taking \vec{v}_0 orthogonal to \vec{B} .

- We simplify the notations, without loss in the generality, by taking \vec{B} “vertical” : $\vec{B} // (y)$.

As a consequence the initial velocity is contained in the “bending plane”, which often happens to be the “horizontal plane”, $\vec{v}_0 \in (Osx)$.

- Projection of $m \frac{d\vec{v}}{dt} = q \vec{v} \times \vec{B}$ onto the axes yields

$$m \begin{vmatrix} \frac{d^2 s}{dt^2} \\ \frac{d^2 x}{dt^2} \\ \frac{d^2 y}{dt^2} \end{vmatrix} = q \begin{vmatrix} \dot{s} \\ \dot{x} \\ \dot{y} \end{vmatrix} \times \begin{vmatrix} 0 \\ 0 \\ B_y \end{vmatrix} = q \begin{vmatrix} \dot{x} B_y \\ -\dot{s} B_y \\ 0 \end{vmatrix} \quad (\text{we introduced } \frac{d(\cdot)}{dt} = \dot{(\cdot)})$$

We consider the usual frame, a direct triadra (s, x, y) .
We take \vec{B} oriented parallel to (y) .

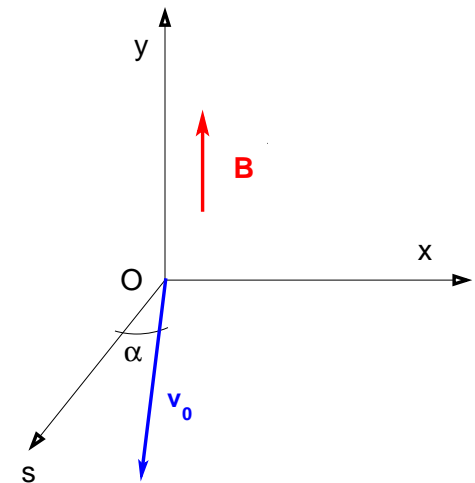

Let's now introduce the “precession frequency”

$$\omega = \frac{qB_y}{m}$$

we then get :

$$\left| \begin{array}{l} \frac{d^2 s}{dt^2} = \omega \dot{x} \quad (1) \\ \frac{d^2 x}{dt^2} = -\omega \dot{s} \quad (2) \\ \frac{d^2 y}{dt^2} = 0 \quad (3) \end{array} \right.$$

Note :

ω is also known as the “cyclotron frequency” i.e., the angular velocity $\frac{d\theta}{dt}$ of a particle in a cyclotron accelerator.

Note that ω does not depend on the radius of the circular trajectory : same period $T = 2\pi/\omega$ to perform one turn ($\theta = 2\pi$), whatever the radius $r = mv / qB$. Just, r is larger if v is larger, ω and $T = 2\pi/\omega$ remain unchanged.

EXERCISE

A magnet is designed for a proton with velocity $0.2c$ to perform precession at a rate of 10^{-6} second per turn.

What magnetic field value is needed ?

What is the radius of the proton orbit in that field ?

1st integration Equations (1)-(3) cannot be solved independently, they are coupled : \dot{x} appears in Eq. (1) whereas \dot{s} appears in Eq. (2).

However a first integration is possible and will allow uncoupling the variables :

$$\frac{dv}{dt} = \begin{cases} \frac{d^2 s}{dt^2} = \omega \dot{x} & (1) \\ \frac{d^2 x}{dt^2} = -\omega \dot{s} & (2) \\ \frac{d^2 y}{dt^2} = 0 & (3) \end{cases} \Rightarrow \begin{cases} \dot{s} - \dot{s}_0 = \omega(x - x_0) \\ \dot{x} - \dot{x}_0 = -\omega(s - s_0) \\ \dot{y} - \dot{y}_0 = 0 \end{cases}$$

We now introduce the initial conditions : $s_0 = 0, x_0 = 0, \dot{y}_0 = 0,$
and thus get the first integrals

$$\begin{cases} \dot{s} = \dot{s}_0 + \omega x & (1') \\ \dot{x} = \dot{x}_0 - \omega s & (2') \\ \dot{y} = 0 & (3') \end{cases}$$

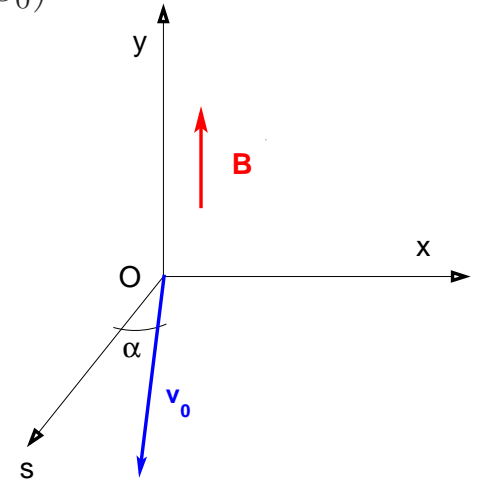

Re-introducing these first integrals into Eqs. (1)-(3) then gives

$$\begin{cases} \frac{d^2 s}{dt^2} = \omega(\dot{x}_0 - \omega s) & i.e., & \frac{d^2 s}{dt^2} + \omega^2 s = \omega \dot{x}_0 & (1'') \\ \frac{d^2 x}{dt^2} = -\omega(\dot{s}_0 + \omega x) & i.e., & \frac{d^2 x}{dt^2} + \omega^2 x = -\omega \dot{s}_0 & (2'') \\ \frac{d^2 y}{dt^2} = 0 & & & (3'') \end{cases}$$

Solving (3'')

Integration of differential equation (3'') is straightforward :

$$\frac{d^2y}{dt^2} = 0 \Rightarrow \frac{dy}{dt} = \dot{y}_0, \quad y = \dot{y}_0 t + y_0$$

Given the initial conditions $\dot{y}_0 = 0, \quad y_0 = 0,$ one gets

$$y=0$$

the motion stays in the (O_{sx}) plane.

Solving the equations of motion (1''), (2'')

$$\left\{ \begin{array}{l} \frac{d^2 s}{dt^2} + \omega^2 s = \omega \dot{x}_0 \quad (1'') \\ \frac{d^2 x}{dt^2} + \omega^2 x = -\omega \dot{s}_0 \quad (2'') \end{array} \right.$$

Integration of (1''), (2'') resorts to the regular techniques for solving a second order differential equation of the form :

$$\frac{d^2 z}{dt^2} + Kz = C, \quad \text{with } C \text{ a constant, } z \text{ stands for either } s \text{ or } x$$

The general solution is the superimposition of the general solution of the homogeneous equation, right hand side zero :

$$\frac{d^2 z}{dt^2} + Kz = 0 \quad (4)$$

with a particular solution of

$$\frac{d^2 z}{dt^2} + Kz = C \quad (5)$$

A mathematical parenthesis :

- **General solution of** $\frac{d^2z}{dt^2} + Kz = 0$:

$$\text{if } K = 0 : z = At + B$$

$$\text{if } K < 0 : z = A \cosh \sqrt{-K}t + B \sinh \sqrt{-K}t$$

$$\text{if } K > 0 : z = A \cos \sqrt{K}t + B \sin \sqrt{K}t$$

- **A and B are integration constants that depend on initial conditions**

- $\left(\begin{array}{l} \cosh \\ \sinh \end{array} (x) = \frac{e^x \pm e^{-x}}{2} \right)$

- **Particular solution of** $\frac{d^2z}{dt^2} + Kz = C$:

$$\text{if } K = 0 : z = C \frac{t^2}{2}$$

$$\text{if } K \neq 0 : z = \frac{C}{K}$$

- **Hence the general solution of** $\frac{d^2z}{dt^2} + Kz = C$:

$$\text{if } K = 0 : z = C \frac{t^2}{2} + At + B$$

$$\text{if } K < 0 : z = A \cosh \sqrt{-K}t + B \sinh \sqrt{-K}t + \frac{C}{K}$$

$$\text{if } K > 0 : z = A \cos \sqrt{K}t + B \sin \sqrt{K}t + \frac{C}{K}$$

EXERCISE

- We consider $\frac{d^2z}{dt^2} + Kz = 0$

Prove that

$$\left| \text{if } K = 0 : z = At + B \quad \mathbf{A \text{ and } B \text{ integration constants}} \right.$$

Prove that

$$\left| \text{if } K > 0 : z = A \cos \sqrt{K}t + B \sin \sqrt{K}t \right.$$

Back now to our earlier system,

$$\left| \begin{array}{l} \frac{d^2 s}{dt^2} + \omega^2 s = \dot{x}_0 \quad (1'') \\ \frac{d^2 x}{dt^2} + \omega^2 x = -\omega \dot{s}_0 \quad (2'') \end{array} \right.$$

Introducing the initial conditions, at $t = 0$: $s_0 = 0, x_0 = 0, \dot{s} = \dot{s}_0, \dot{x} = \dot{x}_0$

we get

$$\left| \begin{array}{l} s = -\frac{\dot{x}_0}{\omega} \cos \omega t + \frac{\dot{s}_0}{\omega} \sin \omega t + \frac{\dot{x}_0}{\omega} \\ x = \frac{\dot{s}_0}{\omega} \cos \omega t + \frac{\dot{x}_0}{\omega} \sin \omega t - \frac{\dot{s}_0}{\omega} \end{array} \right.$$

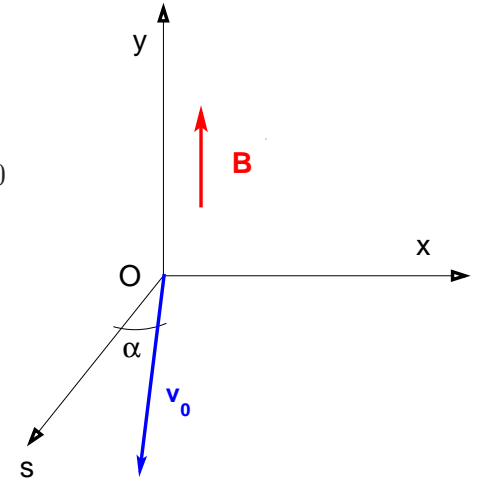

We get the trajectory by eliminating the time t between these equations, which yields,

$$\left| \begin{array}{l} \cos \omega t = 1 + \frac{\omega}{\dot{s}_0^2 + \dot{x}_0^2} (\dot{s}_0 x - \dot{x}_0 s) \\ \sin \omega t = \frac{\omega}{\dot{s}_0^2 + \dot{x}_0^2} (\dot{s}_0 s + \dot{x}_0 x) \end{array} \right. \quad \text{which lends itself to } \cos^2 + \sin^2 = 1, \text{ thus yielding}$$

$$\boxed{\left(s - \frac{\dot{x}_0}{\omega} \right)^2 + \left(x + \frac{\dot{s}_0}{\omega} \right)^2 = \frac{\dot{s}_0^2 + \dot{x}_0^2}{\omega^2}}$$

$$\left(s - \frac{\dot{x}_0}{\omega}\right)^2 + \left(x + \frac{\dot{s}_0}{\omega}\right)^2 = \frac{\dot{s}_0^2 + \dot{x}_0^2}{\omega^2}$$

This is the equation of a circle with radius $\rho = \frac{\sqrt{\dot{s}_0^2 + \dot{x}_0^2}}{|\omega|} = \frac{v_0}{|\omega|}$, centered at $s = \frac{\dot{x}_0}{\omega}$, $x = -\frac{\dot{s}_0}{\omega}$.

DISCUSSION

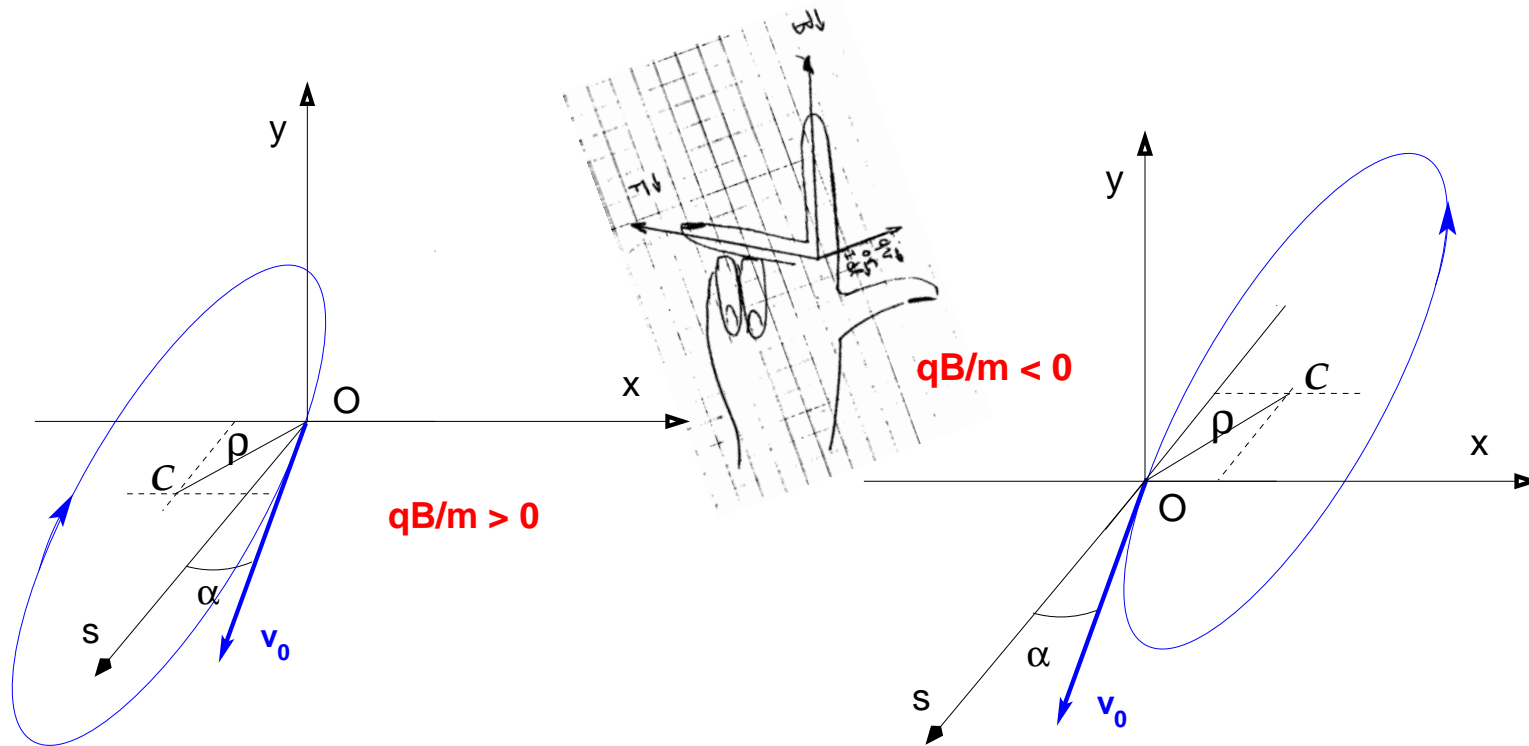

Note : one can write $B\rho = p/q$, given $p = mv$, $v = v_0 = \sqrt{\dot{s}_0^2 + \dot{x}_0^2}$ and $\omega = qB/m$.

We call $B\rho$ the rigidity of the particle.

3 An introduction to guiding and focusing optical elements

Introduction

- **Charged particle beams are guided and focused by means of magnetostatic or electrostatic devices.**

Sometimes both functions of guiding and focusing are combined in a single device.

- **The relative efficiency of electric and magnetic fields scales as follows :**

$$\frac{F_E}{F_B} = \frac{qE}{qvB} = \frac{E[V/m]}{\beta c[m/s]B[T]}$$

With E in \simeq MV/m range at most, B in \simeq Tesla range, thus F_E is orders of magnitude smaller than F_B .

- **As a consequence, only magnetic fields can be efficient in focusing and guiding high energy hadron beams.**

Only at low energy, $\beta < 10^{-1} - 10^{-2}$, are electrostatic devices of interest.

3.1 Magnetic quadrupole

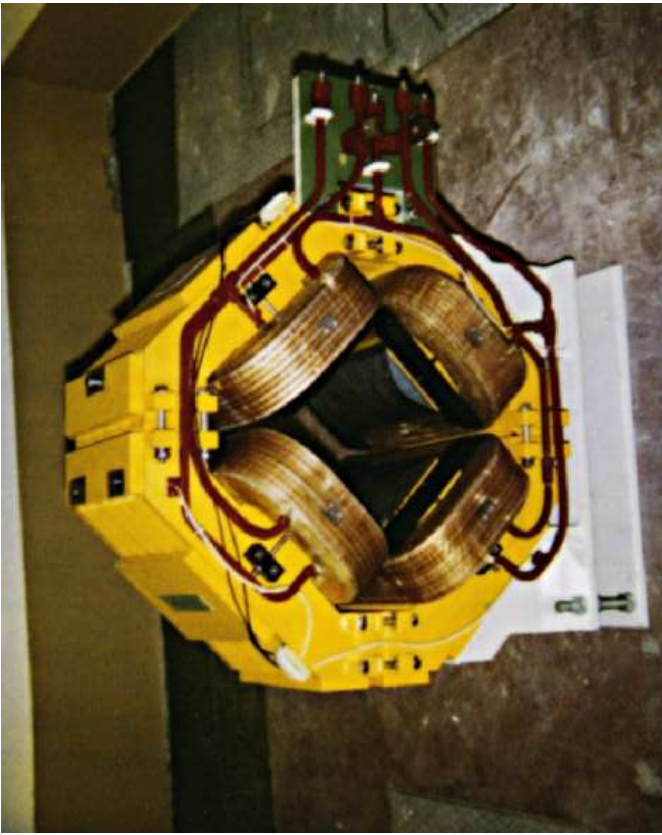

Magnetic quadrupole

A quadrupole is a 4-pole magnetic structure with $\frac{2\pi}{4}$ -symmetry.

Such geometry of the iron and coils assembly realizes a field

$\vec{B}(B_x, B_y, B_s)$ of the form

$$\vec{B} = \begin{cases} B_x = Gy \\ B_y = Gx \\ B_s = 0 \end{cases} \rightarrow \text{in the "ideal" case (no "fringe fields")}$$

That form of the field determines the pole profile, by virtue of Maxwell's equation :

$$\boxed{\text{curl} \vec{B} = \mu_0 \vec{j} = \vec{0}} \quad \text{since in the gap between the poles } \vec{j} \equiv 0.$$

Hence $\vec{B} = +\text{grad}V(x,y)$, $V(x,y)$ the magnetic potential.

As a consequence,

$$\begin{cases} B_x = Gy = +\frac{\partial V}{\partial x} \\ B_y = Gx = +\frac{\partial V}{\partial y} \end{cases} \Rightarrow \boxed{V(x,y) = Gxy}$$

- In the (Oxy) frame the equation of constant- V network is

$$y = \frac{V}{Gx}, \quad (G \text{ is usually referred to as the "field gradient"})$$

This determines a family of rectangular hyperbolae.

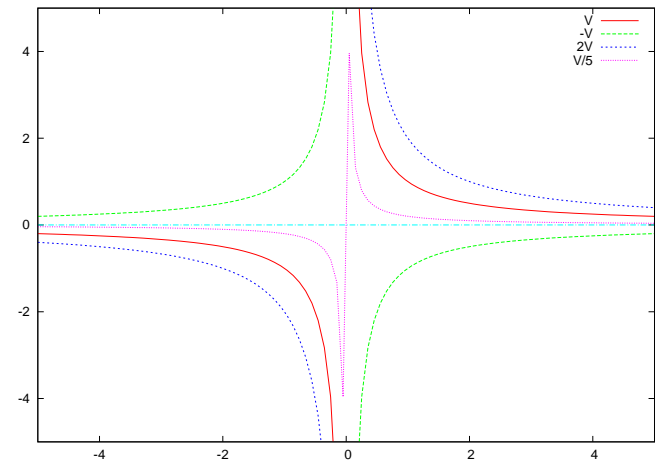
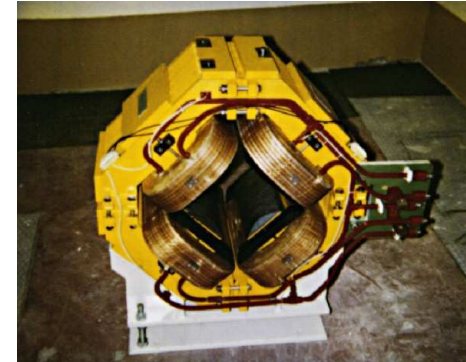

The quadrupole is defined physically by materializing the four branches of the hyperbola.

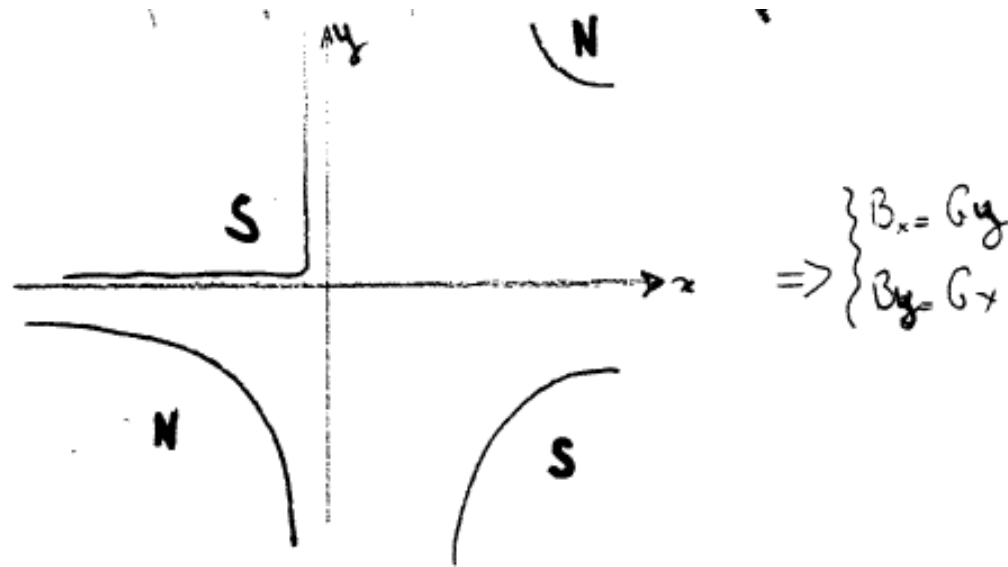

However, generally, a symmetric realization is technologically simple, and allows passage for the particle beam at the center of the quadrupole.

In a practical manner, the hyperbolas are truncated. As a consequence the pole shape is adjusted (departing slightly from an hyperbola) so to ensure constant gradient G in the beam region, the central region in the quadrupole.

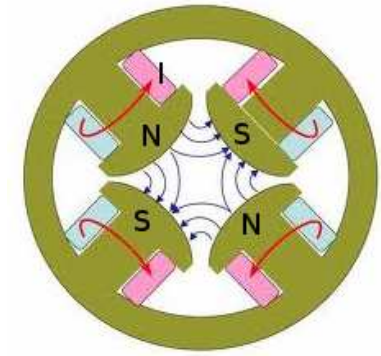
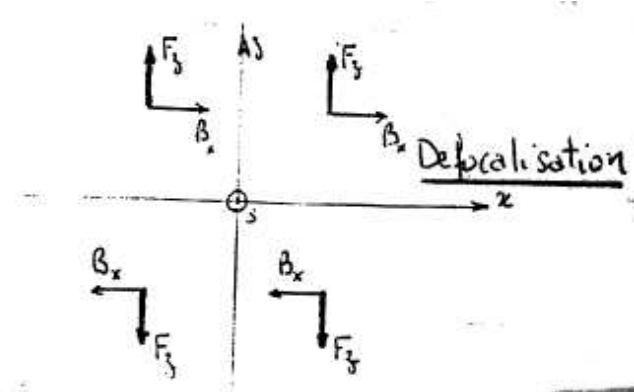
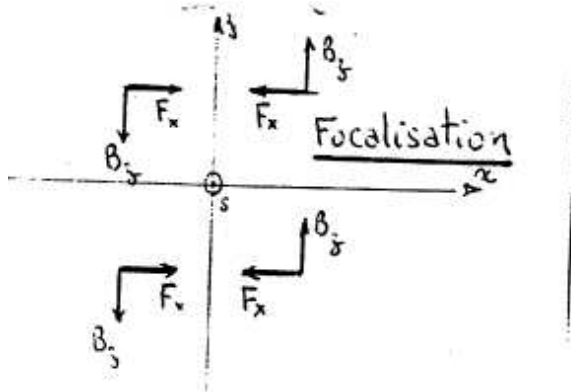

Beam current (e.g., proton velocity) toward us.

Focusing effects :

The horizontal, $F_x = G x$, and vertical, $F_y = G y$, components of the strength

$$\vec{F} = q\vec{v} \times \vec{B}$$

that acts on a moving particle have opposite effects, focusing or defocusing.

The magnetic quadrupole is said to be “focusing in one plane, defocusing in the other”.

Reversing the current in the coils (i.e., changing $\vec{B} \rightarrow -\vec{B}$ in $\vec{F} = q\vec{v} \times \vec{B}$), or reversing the direction of propagation of the beam (i.e., changing $\vec{v} \rightarrow -\vec{v}$ in $\vec{F} = q\vec{v} \times \vec{B}$), will reverse these functions.

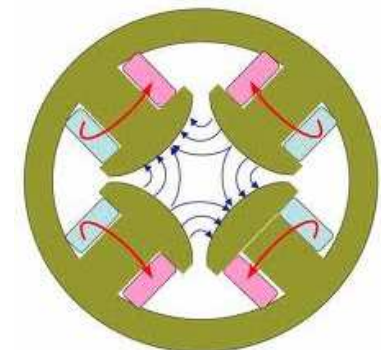

Particle motion in a quadrupole

The equations of motion are obtained in a way similar to what we have seen earlier :

The force law

$$m \frac{d\vec{v}}{dt} = q \vec{v} \times \vec{B}$$

is projected onto the axes, and writes

$$m \frac{d}{dt} \begin{pmatrix} \frac{ds}{dt} \\ \frac{dx}{dt} \\ \frac{dy}{dt} \end{pmatrix} = q \begin{pmatrix} \dot{s} \\ \dot{x} \\ \dot{y} \end{pmatrix} \times \begin{pmatrix} 0 \\ B_x \\ B_y \end{pmatrix} = q \begin{pmatrix} \dot{x}B_y - B_x\dot{y} \\ -\dot{s}B_y \\ \dot{s}B_x \end{pmatrix} \Rightarrow \begin{cases} \frac{d^2x}{dt^2} = -\frac{q}{m}\dot{s}B_y = -\frac{q}{m}vG x \\ \frac{d^2y}{dt^2} = \frac{q}{m}\dot{s}B_x = \frac{q}{m}vG y \end{cases}$$

Here, we have introduced an approximation : we have assumed

$$v = \sqrt{\dot{s}^2 + \dot{x}^2 + \dot{y}^2} = \dot{s} \left(1 + \frac{\dot{x}^2}{\dot{s}^2} + \frac{\dot{y}^2}{\dot{s}^2}\right)^{1/2} = \dot{s} \left(1 + \frac{1}{\dot{s}^2} \left(\frac{dx}{ds} \frac{ds}{dt}\right)^2 + \frac{1}{\dot{s}^2} \left(\frac{dy}{ds} \frac{ds}{dt}\right)^2\right)^{1/2} = \dot{s} (1 + x'^2 + y'^2)^{1/2} \\ \approx \dot{s} \left(1 + \frac{1}{2}x'^2 + \frac{1}{2}y'^2\right) \approx \dot{s},$$

which means that we consider that $\left|\frac{dx}{dt}\right| \ll \left|\frac{ds}{dt}\right|$ and $\left|\frac{dy}{dt}\right| \ll \left|\frac{ds}{dt}\right|$, or equivalently, as to the angles, $\left|\frac{dx}{ds}\right| \ll 1$, $\left|\frac{dy}{ds}\right| \ll 1$.

EXERCISE : Make your own philosophy of that, how can it be figured out that angles are much less than 1 ?

That approximation

$$v = \sqrt{\dot{s}^2 + \dot{x}^2 + \dot{y}^2} \approx \dot{s}$$

to first order in \dot{x} and \dot{y} allows eliminating the time t in the differential equations of the motion, which finally write, **to first order in x and y** :

$$\begin{cases} \frac{d^2x}{ds^2} + \frac{qG}{p} x = 0 \\ \frac{d^2y}{ds^2} - \frac{qG}{p} y = 0 \end{cases}$$

$$K = \frac{qG}{p} = \frac{G}{B\rho} = \frac{\text{quadrupole gradient}}{\text{particle rigidity}} \text{ is the } \underline{\text{quadrupole strength}}.$$

We have calculated earlier the solution of a similar system, which yields, here :

If $K = qG/p = G/B\rho > 0$

i.e., assuming $q > 0$, radially focusing quadrupole, then $G > 0$, $B_y = Gx$ and x have the same sign,

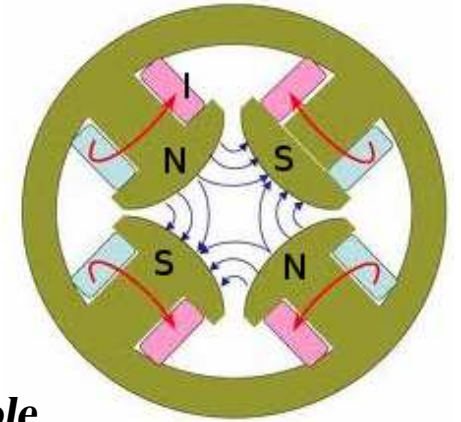

Note : we note $()' = \frac{d}{ds}$ and also $(s - s_0) = L = \text{length of the quadrupole}$

$$\left| \begin{array}{l} x = x_0 \cos \sqrt{K}L + \frac{x'_0}{\sqrt{K}} \sin \sqrt{K}L \\ x' = -x_0 \sqrt{K} \sin \sqrt{K}L + x'_0 \cos \sqrt{K}L \end{array} \right. , \left. \begin{array}{l} y = y_0 \cosh \sqrt{K}L + \frac{y'_0}{\sqrt{K}} \sinh \sqrt{K}L \\ y' = y_0 \sqrt{K} \sinh \sqrt{K}L + y'_0 \cosh \sqrt{K}L \end{array} \right.$$

Hence the transfer matrices :

$$M_x(s \leftarrow s_0) = \begin{bmatrix} \cos \sqrt{K}L & \frac{1}{\sqrt{K}} \sin \sqrt{K}L \\ -\sqrt{K} \sin \sqrt{K}L & \cos \sqrt{K}L \end{bmatrix}, \text{ horizontally focusing lens}$$

$$M_y(s \leftarrow s_0) = \begin{bmatrix} \cosh \sqrt{K}L & \frac{1}{\sqrt{K}} \sinh \sqrt{K}L \\ \sqrt{K} \sinh \sqrt{K}L & \cosh \sqrt{K}L \end{bmatrix}, \text{ vertically defocusing lens.}$$

If $K = qG/p = G/B\rho < 0$

**i.e., assuming $q > 0$, radially defocusing quadrupole,
then $G < 0$, $B_y = Gx$ and x have opposite signs,**

$$\begin{cases} x = x_0 \cosh \sqrt{|K|}L + \frac{x'_0}{\sqrt{|K|}} \sinh \sqrt{|K|}L \\ x' = x_0 \sqrt{|K|} \sinh \sqrt{|K|}L + x'_0 \cosh \sqrt{|K|}L \\ y = y_0 \cos \sqrt{|K|}L + \frac{y'_0}{\sqrt{|K|}} \sin \sqrt{|K|}L \\ y' = -y_0 \sqrt{|K|} \sin \sqrt{|K|}L + y'_0 \cos \sqrt{|K|}L \end{cases}$$

Hence the transfer matrices :

$$M_x(s \leftarrow s_0) = \begin{bmatrix} \cosh \sqrt{|K|}L & \frac{1}{\sqrt{|K|}} \sinh \sqrt{|K|}L \\ \sqrt{|K|} \sinh \sqrt{|K|}L & \cosh \sqrt{|K|}L \end{bmatrix}, \text{ horizontally defocusing lens,}$$

$$M_y(s \leftarrow s_0) = \begin{bmatrix} \cos \sqrt{|K|}L & \frac{1}{\sqrt{|K|}} \sin \sqrt{|K|}L \\ -\sqrt{|K|} \sin \sqrt{|K|}L & \cos \sqrt{|K|}L \end{bmatrix}, \text{ vertically focusing lens.}$$

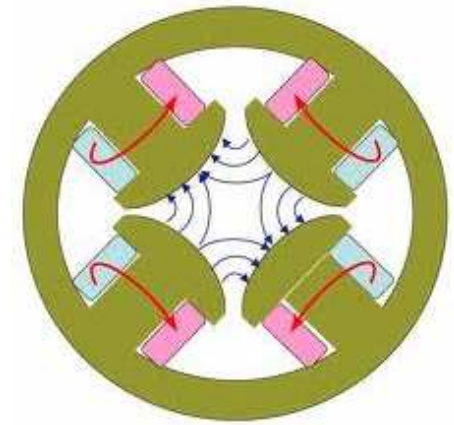

EXERCISE

1/ Using complex algebra, prove that the transfer matrix of a quadrupole can be written under the form

$$M_y(s \leftarrow s_0) = \begin{bmatrix} \cos \sqrt{K}L & \frac{1}{\sqrt{K}} \sin \sqrt{K}L \\ -\sqrt{K} \sin \sqrt{K}L & \cos \sqrt{K}L \end{bmatrix}$$

wether that quadrupole is focusing or defocusing, indifferently.

2/ What if the quadrupole is switched off ?

3/ What is the value of the determinant of a diverging lens ?

A remark concerning the **linear** model

For the transport through a quadrupole lens, we have obtained to the *first order* in x, x', y, y' :

$$M(s \leftarrow s_0) = \begin{bmatrix} \cos \sqrt{K} L & \frac{1}{\sqrt{K}} \sin \sqrt{K} L \\ -\sqrt{K} \sin \sqrt{K} L & \cos \sqrt{K} L \end{bmatrix}$$

This model leans on two approximations :

- **one was explicit :**

$$v = \sqrt{\dot{s}^2 + \dot{x}^2 + \dot{y}^2} = \frac{ds}{dt} (1 + \dot{x}^2/\dot{s}^2 + \dot{y}^2/\dot{s}^2)^{1/2} \approx \frac{ds}{dt}$$

Namely, to first order in dx/ds and dy/ds , $v = \frac{ds}{dt}$,

velocity v is considered to identify with the longitudinal component of the velocity vector.

- the second approximation arises from the technology : the magnetic poles are not perfect hyperbola : they have to be truncated, and they are further adjusted so to ensure $V = Gxy$ in the beam region, a criteria of the so-called “*good-field region*”.

As a consequence, **non-linear components of the magnetic field have been omitted :**

rather than $\left| \begin{array}{l} B_x = Gy \\ B_y = Gx \end{array} \right.$ as in our first order model,

one actually has

$$\left| \begin{array}{l} B_x = Gy + \text{higher order terms in x and y} \\ B_y = Gx + \text{higher order terms in x and y} \end{array} \right.$$

- For instance, as in “combined function” main magnets (CERN PS, BNL AGS) :



From a beam-dynamics practical viewpoint there, higher order term in the development reduce

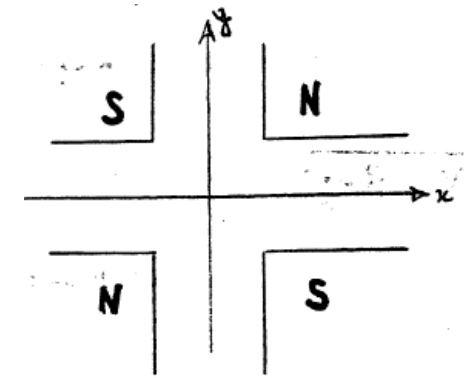

This configuration of the poles causes a superimposition of all multipoles having like symmetry :

Quadrupole :	4×1 pole
dodecapole :	4×3 poles
20-pole :	4×5 pole
etc.	

to a sole weak sextupole component.

The real quadrupole

• It differs from the ideal quadrupole, $V = Gxy$, by two aspects :

- the field in its central region is perturbed, due to the limited extent of the hyperbolic poles,

- the gradient is not constant over the all length of the magnet, see figure.

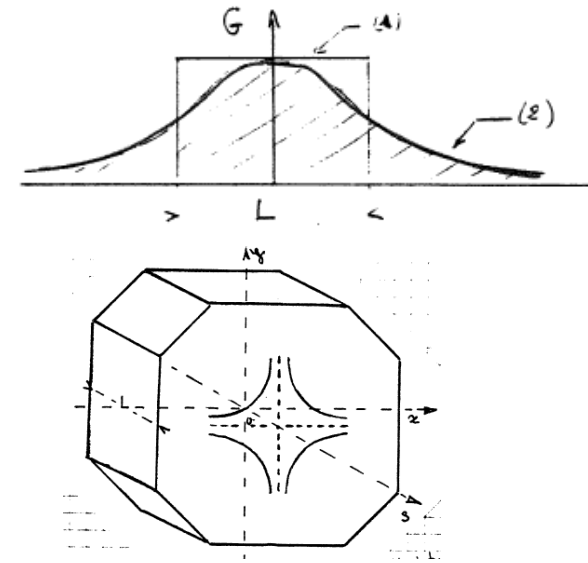

• The real quadrupole with gradient $G(s)$ (curve 2) will yield the same deviation as its “hard edge” model with constant gradient G_0 and length L (curve 1),

namely, it will yield a deviation of : $\Delta \frac{dx}{ds} \approx (-) \frac{q}{p} x \int_{-\infty}^{\infty} G(s) ds$

as long as we note : $\int_{-\infty}^{\infty} G(s) ds = G_0 L$

$$\begin{cases} \frac{d^2 x}{ds^2} + \frac{qG}{p} x = 0 \\ \frac{d^2 y}{ds^2} - \frac{qG}{p} y = 0 \end{cases}$$

• L is called the **gradient length**

• $\frac{G_0}{p/q} = \frac{G_0}{B\rho} = K$ is **the strength** of the quadrupole

• KL is **the integrated strength** of the quadrupole

The thin lens model

- **The thin-lens model is not trivial,**
it is abundantly used for tracking in large machines including colliders as super-B factory, LHC, RHIC
- **In a thick lens the trajectory is progressively deflected at the traversal of the magnet.**
The thin lens model is the limit case where the length

$$L \rightarrow 0$$

(from a practical point of view, this means, $L \ll |f|$),

while maintaining the integrated gradient GL , such to preserve the deviation, which writes

$$\Delta x' = (-) \frac{\int_{-\infty}^{\infty} G(s) ds}{p/q} x = (-) \frac{G_0 L}{B\rho} x = -KL x$$

Note the relationship to the focal distance, as seen in introduction :

$$\Delta x' = \frac{\pm x}{f}, \quad \text{i.e., } KL = -1/f$$

- **Passage to the limit uses Taylor series of the sine and cosine functions :**

$$\cos x = 1 - \frac{x^2}{2} + \dots,$$

$$\sin x = x - \frac{x^3}{6} + \dots$$

$$\cosh x = 1 + \frac{x^2}{2} + \dots,$$

$$\sinh x = x + \frac{x^3}{6} + \dots$$

yielding

$$\begin{bmatrix} \cos \sqrt{K}L & \frac{1}{\sqrt{K}} \sin \sqrt{K}L \\ -\sqrt{K} \sin \sqrt{K}L & \cos \sqrt{K}L \end{bmatrix} = \begin{bmatrix} 1 - KL^2 + \dots & \frac{\sqrt{KL} + \dots}{\sqrt{K}} \\ -\sqrt{K}(\sqrt{KL} + \dots) & 1 - KL^2 \end{bmatrix}$$

$$\xrightarrow{|KL| \ll 1} \begin{bmatrix} 1 & L \\ -KL & 1 \end{bmatrix}$$

$$\xrightarrow{L \rightarrow 0} \begin{bmatrix} 1 & 0 \\ -KL & 1 \end{bmatrix} \quad \begin{array}{l} KL > 0, \text{ focusing lens} \\ KL < 0, \text{ defocusing lens} \end{array}$$

- Using this thin-lens model, a “thick-quadrupole” can be approximated by a upstream-drift/thin-lens/downstream-drift combination,

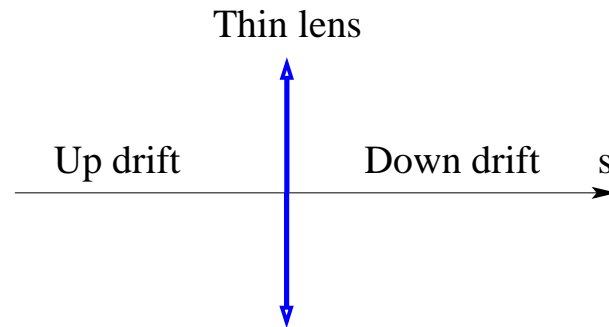

with transfer matrix

$$M = M_{d-drift} \times M_{thin\ lens} \times M_{u-drift}$$

A remark, in complement to the focusing properties of the magnetic quadrupole

- We know how to realize assemblies of lenses, that focus or defocus in both x and y planes :

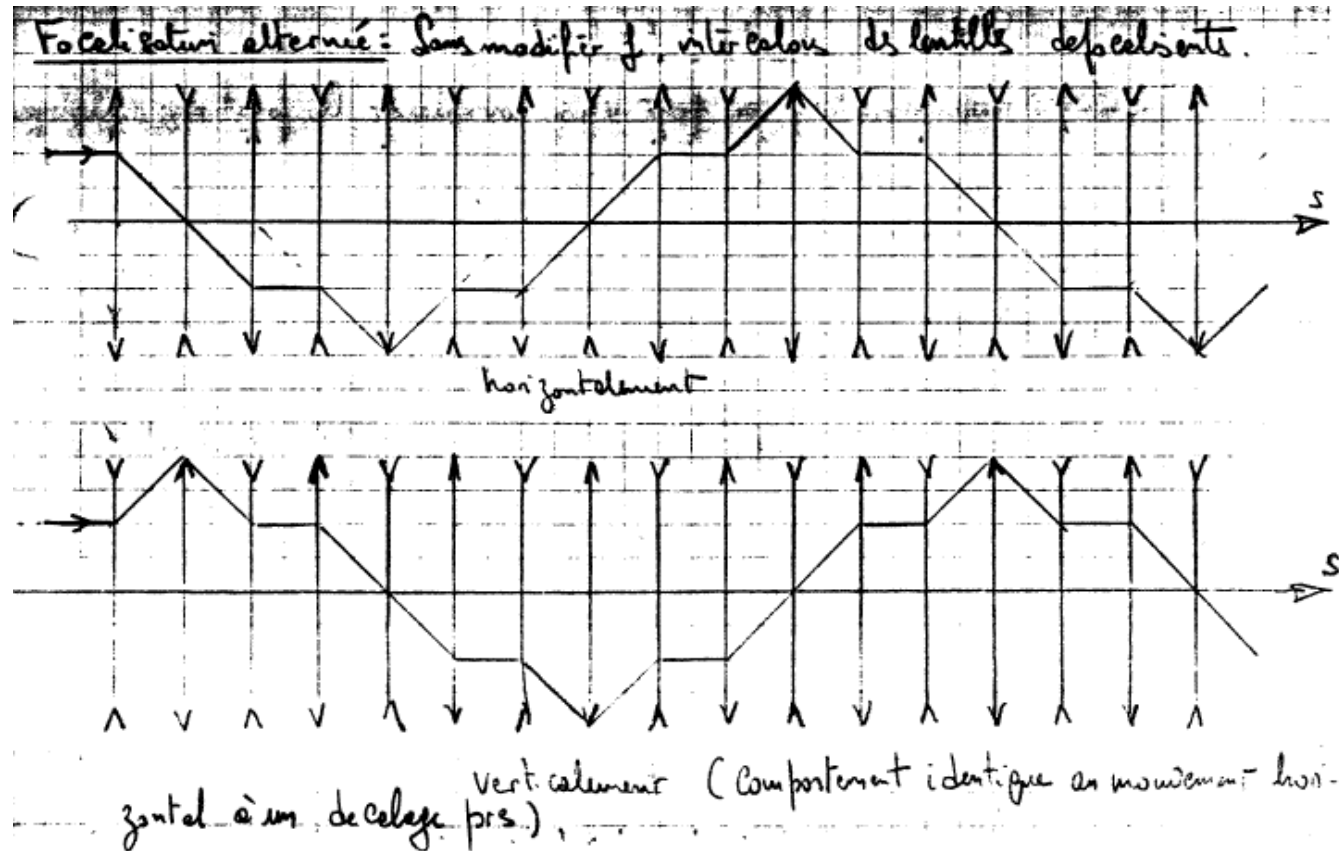

- An optical system maintains its nature, either focusing or defocusing, when attacked backward.

The chromatism of quadrupoles

A quadrupole lens manifests itself by the strength $KL = GL/B\rho$ it applies on a particle that traverses it, and translate into angle kick $\Delta x' = KL\Delta x$.

- Given a gradient $G = \frac{B_{pole-tip}}{r_{pole-tip}}$, it is clear that stiffer particles : particles with greater stiffness $B\rho = \frac{p}{q}$, will be less deflected than particles with smaller stiffness.

This goes as follows. A first integration of our earlier equation

$$\frac{d^2x}{ds^2} + \frac{qG}{p} x = 0$$

yields

$$\Delta \left(\frac{dx}{ds} \right) = \frac{-q}{p} \times \int_{-\infty}^{\infty} G(s) ds = \frac{x}{f} \quad \text{with} \quad f = \frac{p/q}{\int_{-\infty}^{\infty} G(s) ds}$$

- If $f_0 = \frac{p_0/q}{\int_{-\infty}^{\infty} G(s) ds}$ is the focal distance for momentum p_0

and $f = \frac{p/q}{\int_{-\infty}^{\infty} G(s) ds}$ is the focal distance for momentum $p = p_0 + \Delta p$

then the focal distance of the lens undergoes the relative change

$$\frac{f}{f_0} = \frac{p}{p_0} = 1 + \frac{\Delta p}{p_0}$$

- There is an analogy with photon optics : **blue rays (larger refraction index)** are more deflected than **red rays (smaller index)**.

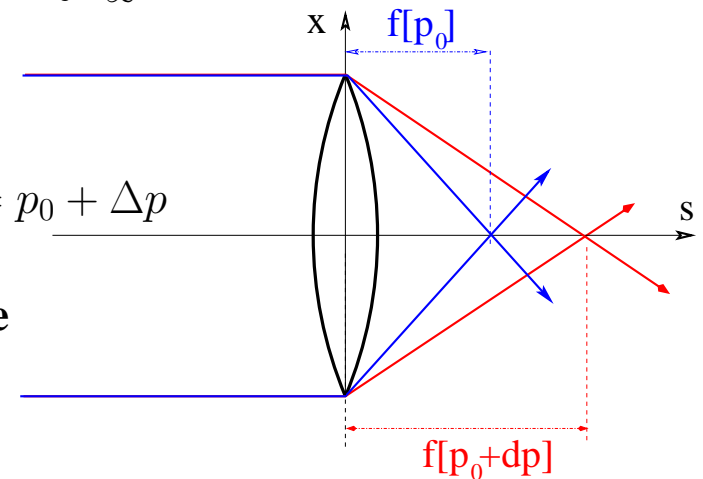

Ampere-turns necessary for obtaining a gradient G

- Hypotheses :

a - We consider a quadrupolar structure with infinite extent in s (this means that we neglect end-fields effects),

b - Magnetic permeability $\mu_r = \infty$ (i.e., no Ampere-turn is spent in the iron, or equivalently, magnetization $H = 0$ in the iron).

- Ampere's theorem tells us that

$$\int_{(C)} \vec{H} \cdot d\vec{l} = NI$$

In the air $H = \frac{B}{\mu_0} = \frac{1}{\mu_0} \sqrt{B_x^2 + B_y^2} = \frac{G}{\mu_0} \sqrt{x^2 + y^2} = \frac{Gr}{\mu_0}$

($\mu_0 = 4\pi 10^{-7}$ V.s/A.m, magnetic permeability of vacuum)

hence, $\int_{gap} H dl = \frac{2G}{\mu_0} \int_0^{pole\ tip} r dr = \frac{G}{\mu_0} r_{pole\ tip}^2$

and

$$NI = \frac{G}{\mu_0} r_{pole\ tip}^2$$

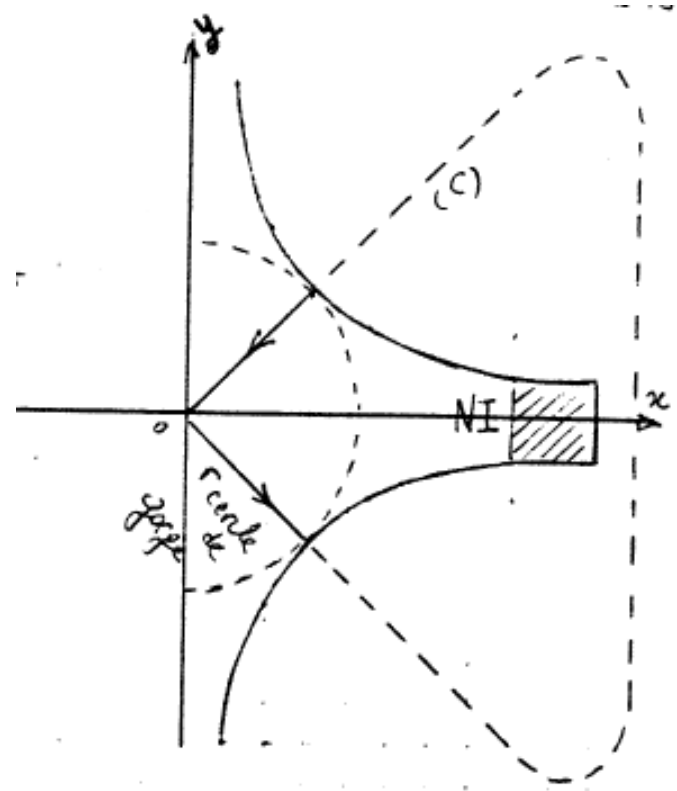

EXERCISE

A 1 MeV proton beam transport line is equipped with a focusing lens, 20 cm long, 10 cm aperture, with 10 meter focal distance.

The power supply provides 1000 A. How many turns is the coil made of ?

Give the field at pole tip, gradient, field strength, and the numerical value of the transfer matrix.

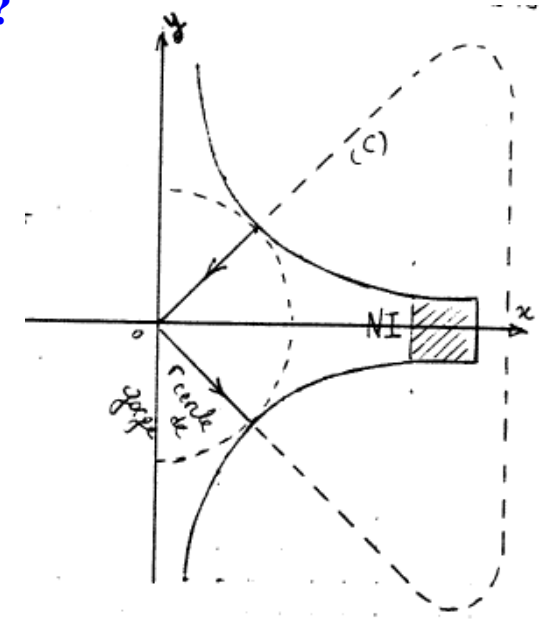

3.2 Electrostatic quadrupole

- Electrostatic quadrupoles can be used to focus low-energy particles.
- Typically, electrostatic fields in the few 100s keV range can be obtained with typically cm-distances between electrodes.
- As a consequence, beams of like energy can be handled.
- The force $\vec{F} = q\vec{E}$ is along \vec{E} , therefore, in order to fulfill the function of focusing along both (x) and (y) axes, the quadrupole should satisfy :

$$\begin{cases} E_x = -Kx \\ E_y = +Ky \end{cases}$$

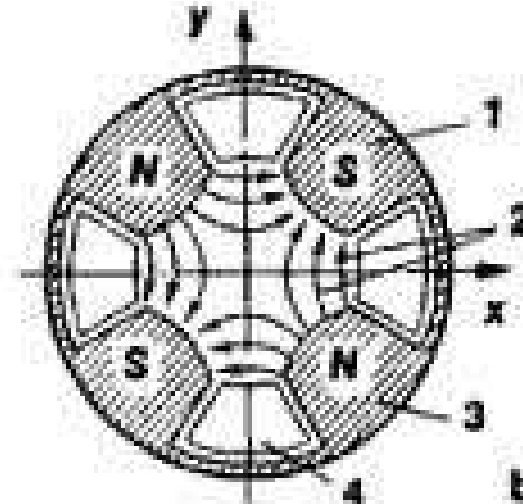
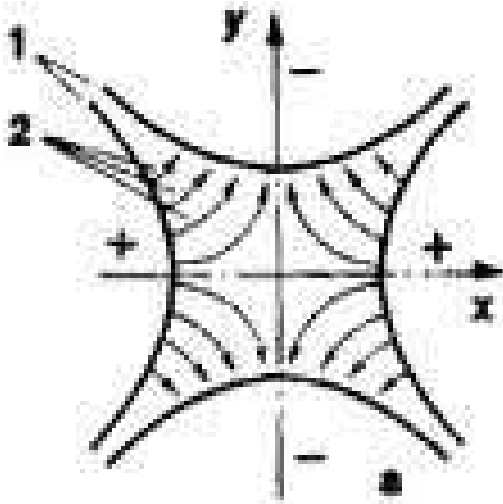

Electrostatic quadrupole

On the other hand, we know from the laws of electrostatics that

$$\vec{E} = -\text{grad}V$$

No magnetic field \vec{B} here, no time-varying \vec{B} , $\text{curl}\vec{E} = -\frac{\partial\vec{B}}{\partial t} = 0$,

\vec{E} derives from a scalar potential, by virtue of $\text{curl}(\text{grad}) = 0$.

- Hence the quadrupole should satisfy, with V the scalar potential :

$$\begin{cases} E_x = -Kx = -\frac{\partial V}{\partial x} \\ E_y = +Ky = -\frac{\partial V}{\partial y} \end{cases}$$

so, the electrostatic potential has to have the form $V = \frac{K}{2}(x^2 - y^2)$.

- The equipotentials satisfy $y = \pm\sqrt{x^2 - \frac{2V}{K}}$ these are rectangular hyperbolas with axes rotated 45° in the (Oxy) frame. In effect, writing

$$\begin{Bmatrix} u \\ v \end{Bmatrix} = \begin{bmatrix} \cos 45^\circ & -\sin 45^\circ \\ \sin 45^\circ & \cos 45^\circ \end{bmatrix} \begin{Bmatrix} x \\ y \end{Bmatrix} = \begin{bmatrix} \frac{\sqrt{2}}{2} & -\frac{\sqrt{2}}{2} \\ \frac{\sqrt{2}}{2} & \frac{\sqrt{2}}{2} \end{bmatrix} \begin{Bmatrix} x \\ y \end{Bmatrix}, \text{ hence } \begin{Bmatrix} x \\ y \end{Bmatrix} = \begin{bmatrix} \frac{\sqrt{2}}{2} & \frac{\sqrt{2}}{2} \\ -\frac{\sqrt{2}}{2} & \frac{\sqrt{2}}{2} \end{bmatrix} \begin{Bmatrix} u \\ v \end{Bmatrix}$$

In this change of axes, $V = \frac{K}{2}(x^2 - y^2)$ transforms to $V = \frac{K}{2}uv$, equation of the right rectangular hyperbola.

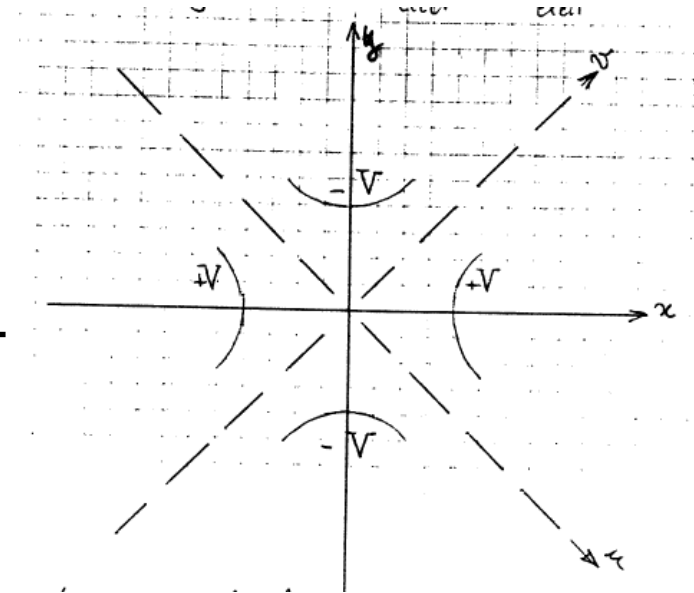

- **To summarize : An electrostatic quadrupole with its electrodes tilted by 45° with respect to the x, y axes realizes the same focusing function as a magnetic quadrupole.**

- **Careful though :**

A charged particle coming from $-\infty$, when reaching the region of an electrostatic element will penetrate a region with changing electrostatic potential.

This change in potential results in acceleration or deceleration of the particle, i.e. in a change in particle velocity, mass, kinetic energy, total energy, rigidity...

This change needs be taken into account in the transport formalism : matrix transport or other.

- **However, very often assumptions are made as :**

- paraxial motion
- negligible longitudinal effects of electric fields
- identical upstream and downstream potential
- etc.

thus allowing use of transport formalism similar to magnetic elements.

- **Main advice :**

One should be cautious about these hypotheses and their validity regarding the electrostatic optical system to be dealt with.

3.3 Relative efficiency of magnetic and electrostatic quadrupoles

From $\vec{F} = q\vec{E} + q\vec{v}\vec{B}$ one draws the equivalence $E = \beta cB$, E in Volt/meter, B in Tesla, $c = 299792458$ m/s

From a technological viewpoint, it is difficult to realize electric fields larger than

$$E_{max} \approx 300000 \text{ V/cm} = 3 \cdot 10^7 \text{ V/m}, \quad 30 \text{ MV/m}$$

For $\beta = 1$, E_{max} corresponds to $B = \frac{E_{max}}{c} = 0.1 \text{ T}$

For $\beta = 0.1$, E_{max} corresponds to $B = \frac{E_{max}}{\beta c} = 1 \text{ T}$

We do know how to realize “warm magnets” providing $B \approx 1.8 \text{ T}$, and even 2 to 3 Tesla in some applications, spectrometers for instance.

Superconductivity allows even more, up to 5 - 10 Tesla.

- $\beta = 0.1$ for proton : kinetic energy $E - M = M/\sqrt{1 - \beta^2} - M \approx \frac{1}{2}mv^2 = 4.7 \text{ MeV}$, rigidity $B\rho = \sqrt{T(T + 2M)} \approx \sqrt{2MT} = 0.3 \text{ T.m}$
- note that $B\rho = 0.3 \text{ T.m}$ using $B = 1 - 0.1 \text{ Tesla}$ means curvature radius 0.3 – 3 meter about convenient from Lab. viewpoint (large ρ means large experimental room, more costly)
- Conclusion : the relative weakness of electrostatic lenses limits their use to “Low Energy Beam Lines” in proton and ion installations.

3.4 Skew quadrupole

A skew quadrupole couples the horizontal (x, x') and vertical (y, y') motions :

- the differential equation for x contains y
- the differential equation for y contains x

RIGHT QUADRUPOLE

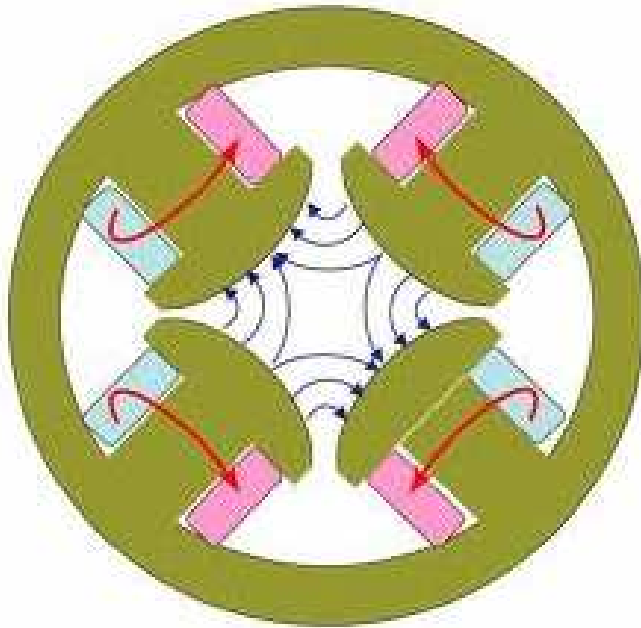

$$\begin{cases} \frac{d^2x}{ds^2} + Kx = 0 \\ \frac{d^2y}{ds^2} - Ky = 0 \end{cases}, \quad \text{non coupled motion.}$$

SKEW QUADRUPOLE

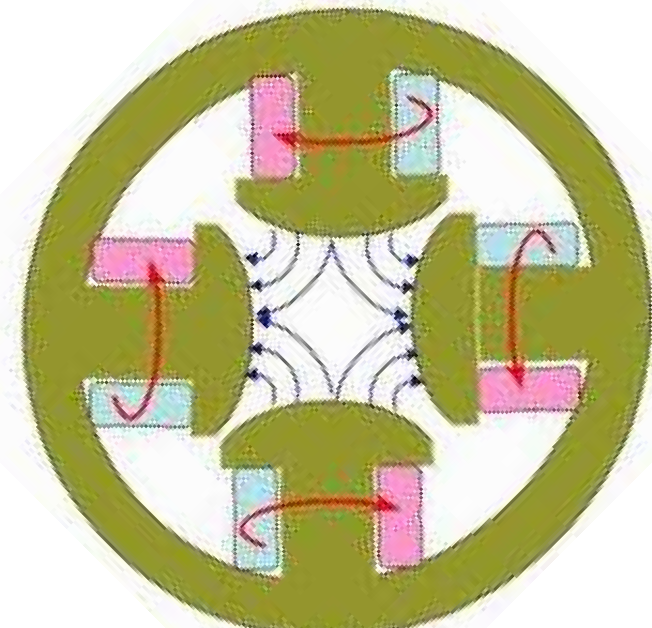

$$\begin{cases} \frac{d^2x}{ds^2} + Ny = 0 \\ \frac{d^2y}{ds^2} - Nx = 0 \end{cases}, \quad \text{coupled motion.}$$

3.5 Non-linear magnetic multipoles

Non-linear lenses are used in transport lines to correct aberrations :

- chromatic aberrations
- geometrical aberrations of second order (introduced by second order terms in x, y in the equation of motion)
- of third and higher order

They may also be used to partially compensate space charge effects

In some cases they may be introduced in a beam line to, on contrary, cause particular distortions to the beam.

In circular accelerators they may be used for the correction of optical defects or as well for the control of various parameters of the accelerator as

- the variation of the wave numbers with energy, with amplitude
- dynamic aperture
- excitation of an extraction resonance,
- compensation of collective effects,
- etc.

Sextupole, 2×3 poles



Sextupole

• **Functions :**

- realize a component B_y proportional to x^2 (**upright sextupole**)
cf. upright quadrupole $\Rightarrow B_y$ proportional to x
- realize a component B_y proportional to y^2 (**skew sextupole**)
cf. skew quadrupole $\Rightarrow B_y$ proportional to y

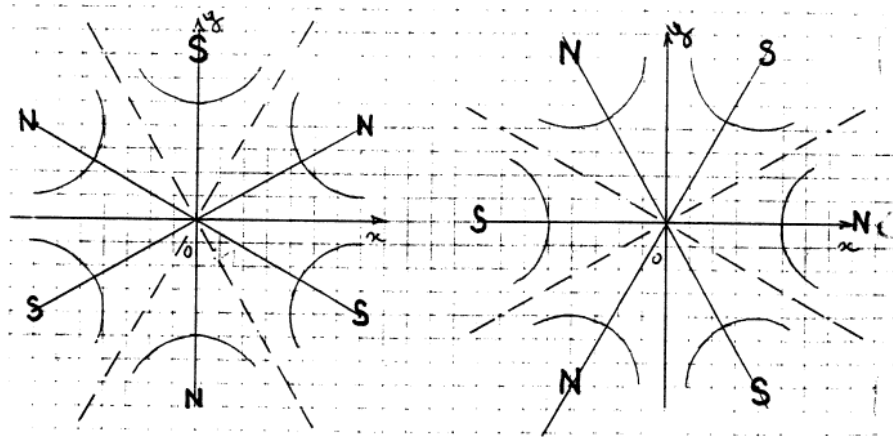

Upright sextupole

$$B_x = 2Hxy$$

$$B_y = H(x^2 - y^2)$$

Pole profile and equipotentials satisfy

$$H(x^2 - y^2/3)y = \text{Cte}$$

Skew sextupole

$$B_x = H(x^2 - y^2)$$

$$B_y = -2Hxy$$

Pole profile and equipotentials satisfy

$$H(x^2/3 - y^2)x = \text{Cte}$$

- **Upright sextupoles** are used to
 - correct chromatic aberrations (introduced by quadrupoles), correct geometrical aberrations
 - modify the momentum dependence of the wave numbers, in a ring (the “chromaticity”)
 - excite resonant extraction (“slow extraction”)
- **Skew sextupoles** are used to correct optical aberrations.

Octupole, 2×4 poles

Functions :

- realize a component B_y proportional to x^3 (upright octupole)
- realize a component B_y proportional to y^3 (skew octupole)

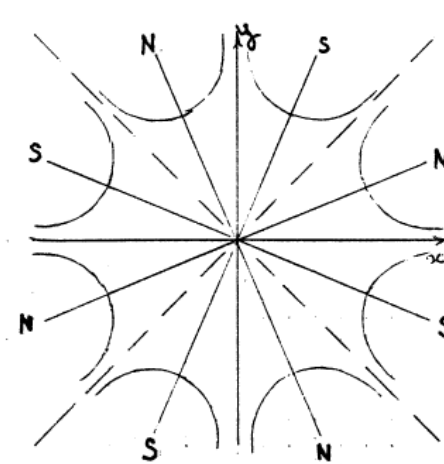

Upright octupole

$$B_x = O(3x^2 - y^2)y$$

$$B_y = O(x^2 - 3y^2)x$$

The pole profile follows the equipotentials

$$O(x^2 - y^2)xy = \text{Cte}$$

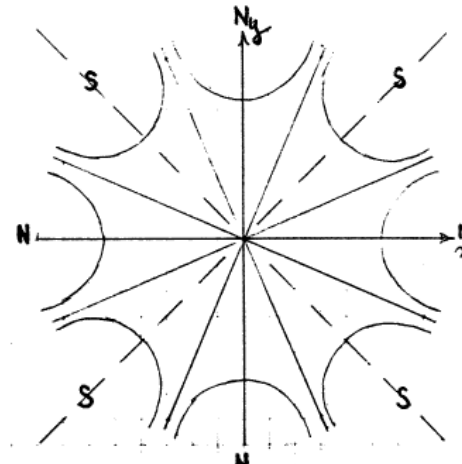

Skew octupole

$$B_x = O(x^2 - 3y^2)x$$

$$B_y = O(3x^2 - y^2)y$$

The pole profile follows the equipotentials

$$O(x^4 - 6x^2y^2 + y^4) = \text{Cte}$$

- **Octupoles are used to**

- correct optical aberrations,
- modify the behavior of the wave numbers as a function of the amplitude of particle motion (an effect in rings known as incoherent dispersion of wave numbers, or “Landau damping”)

An example : beam uniformization using an octupole

This is an example of a particular use of octupole lens in a beam transport line.

The role of the lens is to distort the beam so to get a uniform particle density distribution on some downstream target.

Particle trajectories

Final “phase space”

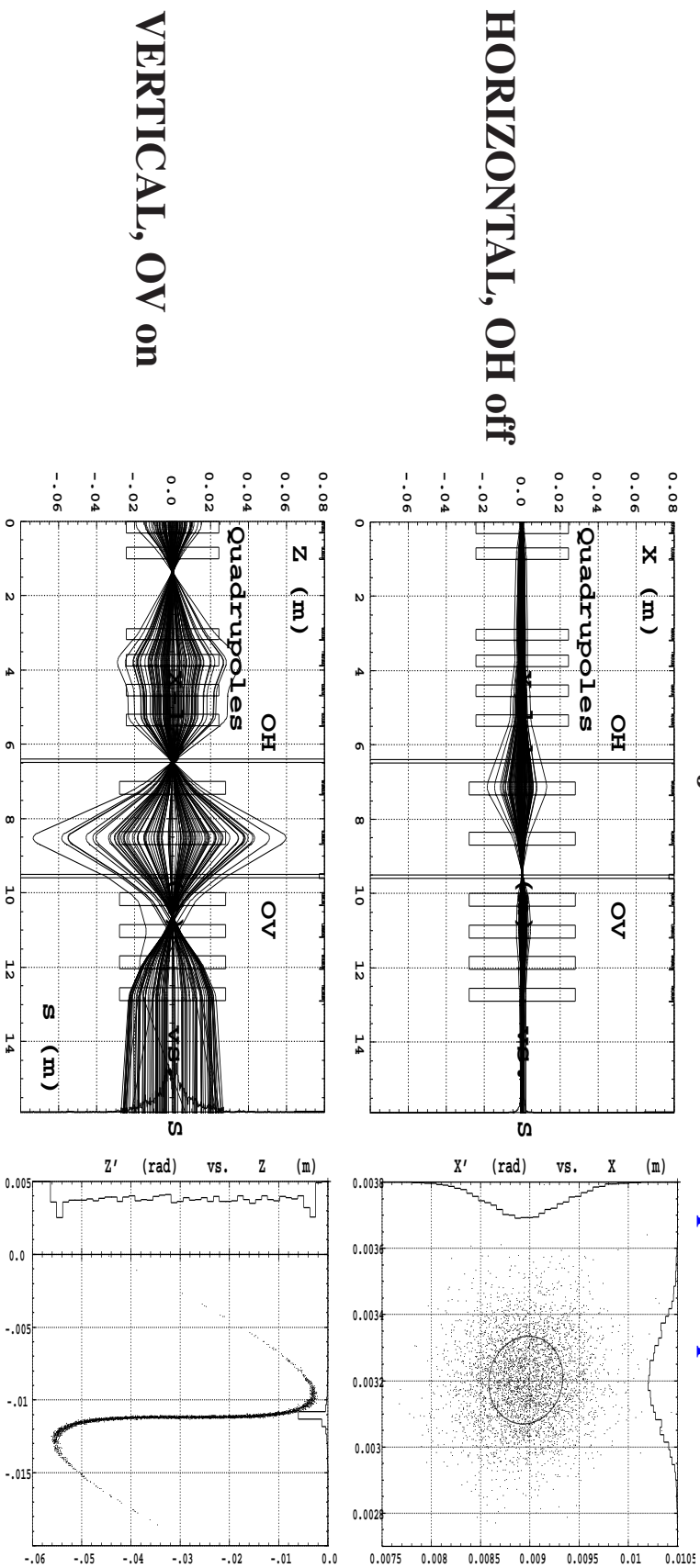

The octupole “integrated strength” OL satisfies $OL =$

$$\frac{1}{12\epsilon_z\beta_{\text{lens}}^2} \frac{\cos^3\phi}{\sin\phi}$$

BOTH OCTUPOLES ON :

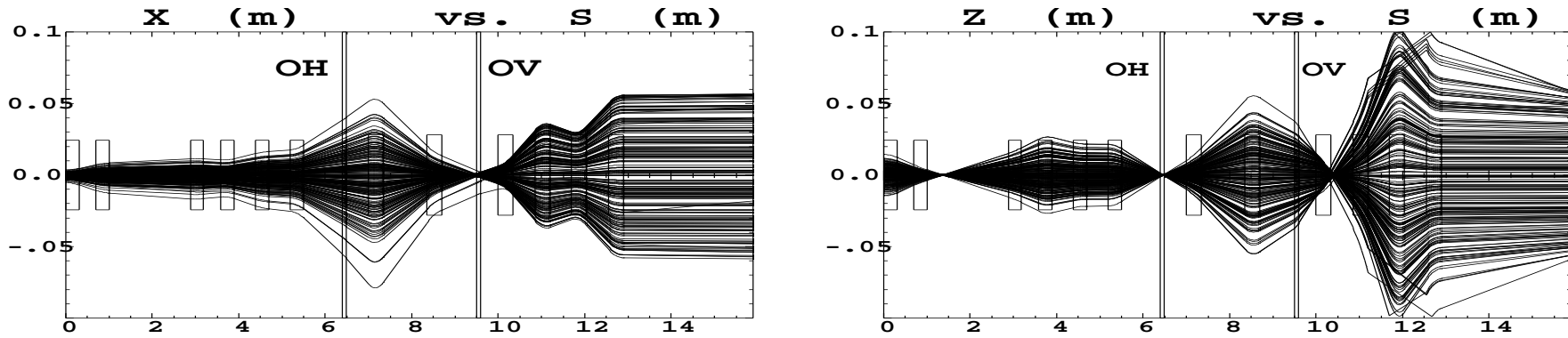

2-D uniformisation at target, beam trajectories.

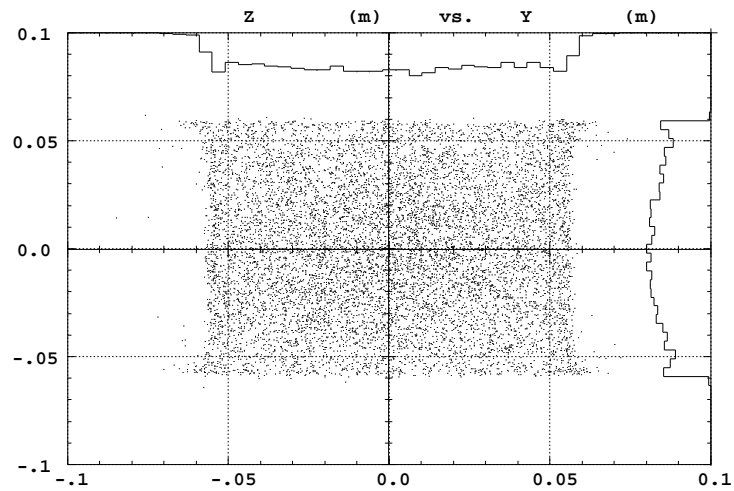

Transverse section of the beam at target.

3.6 Dipole electromagnet - “bending magnet”

Particle motion in a uniform magnetic field perpendicular to the velocity

We have seen that a magnetic field does not work, the particle energy remains unchanged during the motion, its mass stays constant.

The particle is subject to the following forces :

1 - centrifugal force, $\vec{F}_c = m \frac{v^2}{\rho}$, outward

2- Laplace magnetic force, $F_{Laplace} = -qvB$, centripetal, inward (we assume $q > 0$)

Thus the total force is $F_t = m \frac{v^2}{\rho} - qvB$, whereas equilibrium requires $F_t = 0$, hence :

$$B\rho = \frac{p}{q} \quad \text{with } p = mv$$

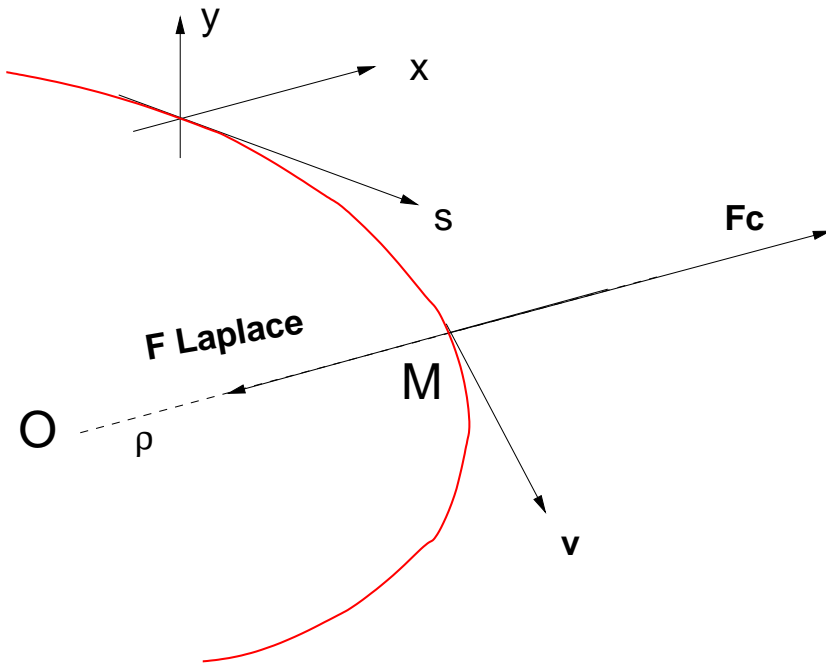

The quantity $B\rho$ is **the rigidity of the particle**, it is measured in Tesla×meter.

The trajectory of the particle in uniform \vec{B} is a circle with radius $\rho = \frac{p}{qB} = \frac{m\beta c}{qB}$

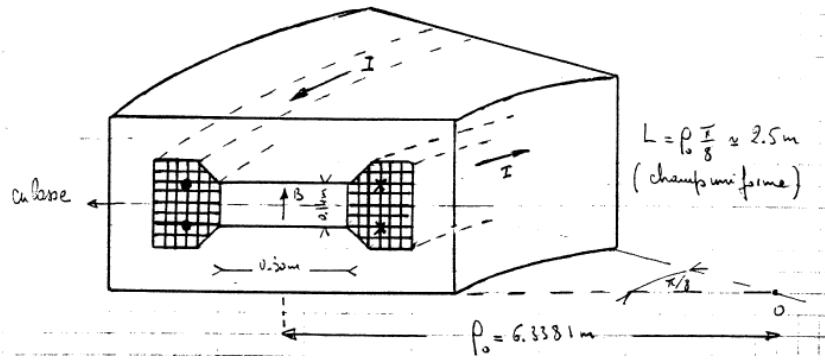

A typical representation of a bending magnet providing a uniform field B for the beam that follows a circle in the central region of the gap.

Here a “sector dipole”, with $\pi/8$ deviation : 8 such dipoles would allow closing a ring accelerator.

The Ampere.turns necessary to the obtention of B are realized by means of large number, N , of windings around the upper and lower magnet poles.

The current, I , in the winding is of several 1000 Amperes.

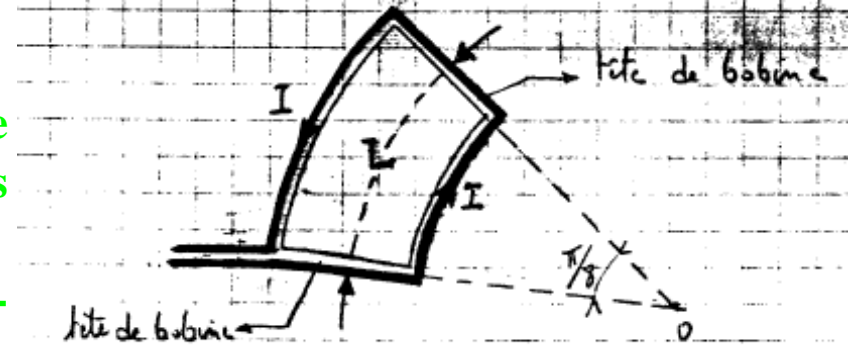

The role of the iron yoke is

- (i) to confine the magnetic flux within the magnet volume
- (ii) to guide it into the gap, where the beam passes
- (iii) to ensure uniform flux in the “good field region”

The yoke may be realized by stacking ≈ 1.5 mm metal sheets.

Doing so limits the eddy currents produced by the variation of B when the magnet is “ramped”.

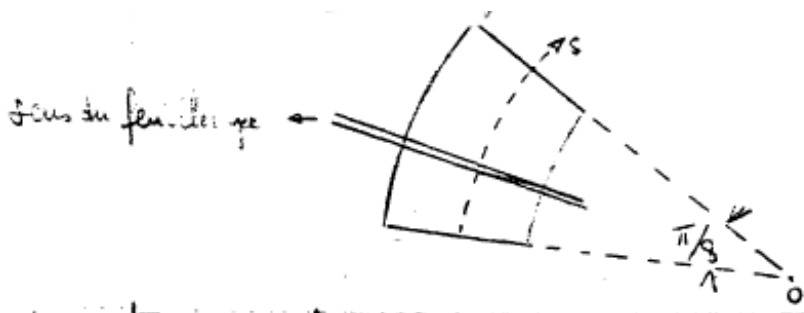

The Ampere×turns to be provided :

Up to $B = 1.5$ Tesla about, the iron channels the magnetic flux in a quasi-perfect way.

In effect, $\mu_r \approx 3000 \approx \infty$, so that practically no ampere-turns are spent in the iron.

Beyond 1.5-1.8 Tesla more or less, the magnetic quality of iron degrades, μ_r decreases, effective ampere-turns (those in the gap) turn to a fraction of the ampere-turns supplied by the magnet power supply, in addition magnetic saturation in the iron affects the yoke in a non-uniform manner so that the quality of the field in the gap deteriorates...

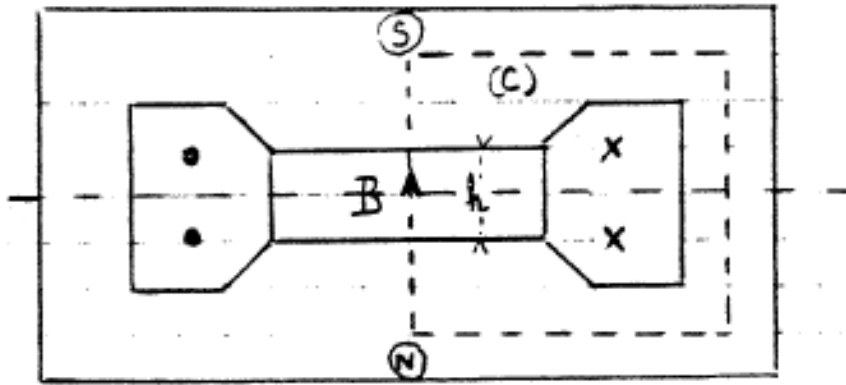

In the gap, the magnetic excitation $H_{gap} = \frac{B_{gap}}{\mu_0}$

In the iron, $B_{iron} = B_{gap}$ (continuity of the normal component of \vec{B}), so that $H_{iron} = \frac{B_{iron}}{\mu_r \mu_0} \approx \frac{B_{gap}}{3 \cdot 10^3 \mu_0}$

hence $H_{iron} \approx 0.3 \cdot 10^{-3} H_{gap}$.

Applying Ampere's theorem to the circuit (C) on the figure yields :

$$NI = \int_{(C)} \vec{H} \cdot d\vec{l} = \int_{gap} H_{gap} \cdot dl + \int_{iron} H_{iron} \cdot dl \approx H_{gap} h \left(1 + \frac{H_{iron} l_{iron}}{H_{gap} h} \right) \approx H_{gap} h, \text{ hence } \boxed{NI \approx \frac{B_{gap} h}{\mu_0}}$$

EXERCISE

Protons are accelerated to 3 GeV kinetic-energy in a ring based on the earlier magnet (curvature radius $\rho = 6.3381$ m, gap height $h = 0.14$ m). The magnet power supply provides 4000 Amperes.

- Find the magnetic field value to be achieved in the gap.
- Find the number of ampere-turns and the number of turns in the magnets.
- How many such magnets are needed to make up a ring accelerator ?

Hint : first find the rigidity, $B\rho$.

Particle motion in a magnetic dipole with field index

The “field index” in a dipole is created by giving the poles a hyperbolic shape :

following the “ $V = xy$ ” quadrupole profile as seen earlier.

Such dipole can be considered as a quadrupole traversed “off-axis”.

The quantity $n = -\frac{\rho}{B_y} \frac{\partial B_y}{\partial x}$, “field index”,

is a measure of the focusing (or defocusing) effect of the varying gap.

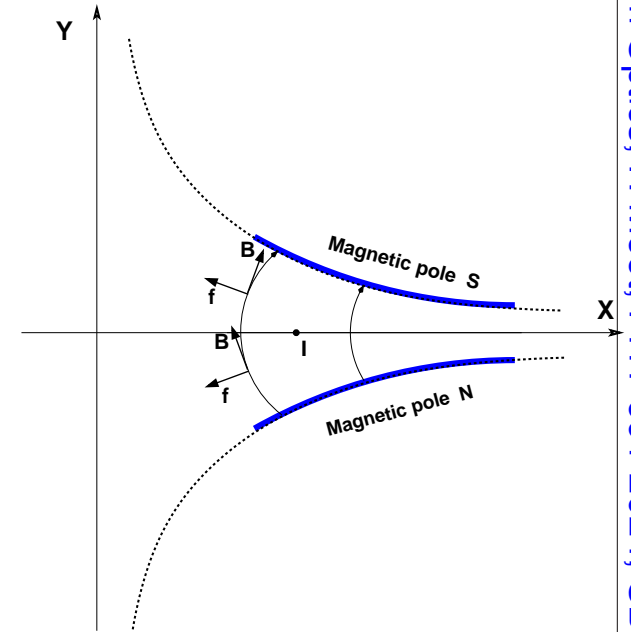

EXERCISE

Consider a dipole with “tapered” gap :

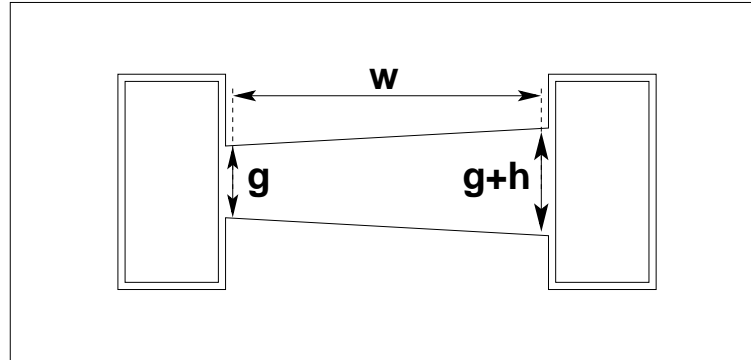

Show that the field index $-\frac{1}{B} \frac{dB}{dx}$ so created takes the value

$$\frac{h}{g w}$$

A reference trajectory can be defined, characterized by $B_0\rho_0 = \frac{p_0}{q}$

The equations of small amplitude motion around that reference curve, $(x = \rho - \rho_0, y)$, derive from

$$\frac{d\vec{p}}{dt} = q\vec{v} \times \vec{B}$$

Two particular ingredients need be introduced in the first order approximation in x and y , namely

- the approximation $v = \frac{ds}{dt} \left[\left(1 + \frac{x}{\rho}\right) + x'^2 + y'^2 \right]^{1/2}$ which now accounts for the curvature $1/\rho$,

- the distance to the reference momentum : $p = p_0 + \Delta p$ which will be observed to introduce a first order effect.

Assuming still, $ds = vdt$ to first order in dx and dy .

Thus one gets the differential equations that describe the motion :

$$\begin{cases} \frac{d^2x}{ds^2} + \frac{1-n}{\rho_0^2} x = \frac{1}{\rho_0} \frac{\Delta p}{p} \\ \frac{d^2y}{ds^2} + \frac{n}{\rho_0^2} y = 0 \end{cases}$$

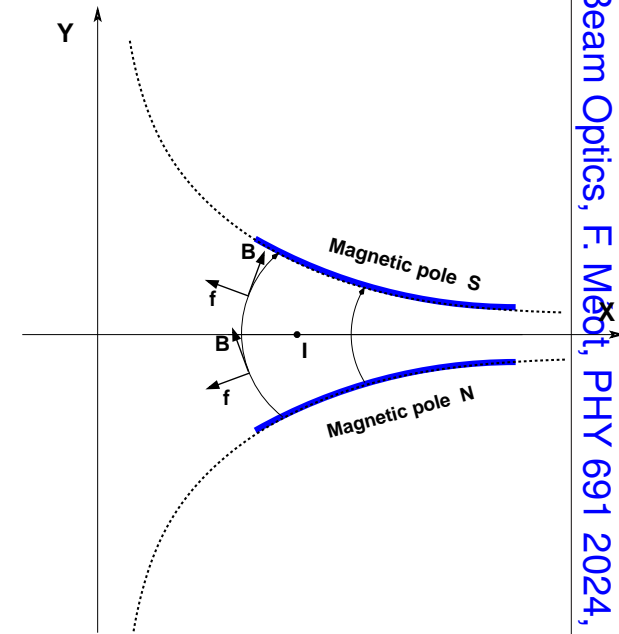

The resolution of these equations is similar to the quadrupole case,

Namely, by superimposition of the general solution of the homogeneous equation and of a particular solution to the inhomogeneous equation, this yields :

Radial motion, with $\mathcal{L} = (s - s_0)$ being the path length along the trajectory arc :

if $(1 - n) > 0$:

$$\left\{ \begin{array}{l} x = x_0 \cos \frac{\sqrt{1-n}}{\rho_0} \mathcal{L} + \frac{x'_0}{\sqrt{1-n}} \sin \frac{\sqrt{1-n}}{\rho_0} \mathcal{L} + \frac{\rho_0}{\sqrt{1-n}} (1 - \cos \frac{\sqrt{1-n}}{\rho_0} \mathcal{L}) \frac{\Delta p}{p} \\ x' = -x_0 \frac{\sqrt{1-n}}{\rho_0} \sin \frac{\sqrt{1-n}}{\rho_0} \mathcal{L} + x'_0 \cos \frac{\sqrt{1-n}}{\rho_0} \mathcal{L} + \frac{\rho_0}{\sqrt{1-n}} \sin \frac{\sqrt{1-n}}{\rho_0} \mathcal{L} \frac{\Delta p}{p} \end{array} \right.$$

if $(1 - n) < 0$:

$$\left\{ \begin{array}{l} x = x_0 \cosh \frac{\sqrt{n-1}}{\rho_0} \mathcal{L} + \frac{x'_0}{\sqrt{n-1}} \sinh \frac{\sqrt{n-1}}{\rho_0} \mathcal{L} + \frac{\rho_0}{n-1} (1 - \cosh \frac{\sqrt{n-1}}{\rho_0} \mathcal{L}) \frac{\Delta p}{p} \\ x' = x_0 \frac{\sqrt{n-1}}{\rho_0} \sinh \frac{\sqrt{n-1}}{\rho_0} \mathcal{L} + x'_0 \cosh \frac{\sqrt{n-1}}{\rho_0} \mathcal{L} + \frac{\rho_0}{n-1} \sinh \frac{\sqrt{n-1}}{\rho_0} \mathcal{L} \frac{\Delta p}{p} \end{array} \right.$$

Remark : Note the additional term compared to the motion in a quadrupole, the dispersive term in $\Delta p/p$, brought in by the particular solution of the inhomogeneous equation $\frac{d^2 x}{ds^2} + \frac{1-n}{\rho_0^2} x =$

$$\frac{1}{\rho_0} \frac{\Delta p}{p} \text{ (whereas the rhs term was zero for the quadrupole : } \left. \begin{array}{l} \frac{d^2 x}{ds^2} + \frac{qG}{p} x = 0 \\ \frac{d^2 y}{ds^2} - \frac{qG}{p} y = 0 \end{array} \right).$$

Axial motion :**if** $n > 0$:

$$\left| \begin{array}{l} y = y_0 \cos \frac{\sqrt{n}}{\rho_0} \mathcal{L} + \frac{y'_0}{\sqrt{n}} \sin \frac{\sqrt{n}}{\rho_0} \mathcal{L} \\ y' = -y_0 \frac{\sqrt{n}}{\rho_0} \sin \frac{\sqrt{n}}{\rho_0} \mathcal{L} + y'_0 \cos \frac{\sqrt{n}}{\rho_0} \mathcal{L} \end{array} \right.$$

if $n < 0$:

$$\left| \begin{array}{l} y = y_0 \cosh \frac{\sqrt{-n}}{\rho_0} \mathcal{L} + \frac{y'_0}{\sqrt{-n}} \sinh \frac{\sqrt{-n}}{\rho_0} \mathcal{L} \\ y' = y_0 \frac{\sqrt{-n}}{\rho_0} \sinh \frac{\sqrt{-n}}{\rho_0} \mathcal{L} + y'_0 \cosh \frac{\sqrt{-n}}{\rho_0} \mathcal{L} \end{array} \right.$$

Summarizing under the form of 5×5 transport matrices

For simplification of the notations we introduce

$$k_x = |1 - n|/\rho_0^2, \quad k_y = |n|/\rho_0^2$$

If $n \leq 0$:

The dipole is horizontally focusing and vertically defocusing

$$\begin{pmatrix} x \\ x' \\ y \\ y' \\ \frac{\delta p}{p} \end{pmatrix} = \begin{pmatrix} \cos \sqrt{k_x} \mathcal{L} & \frac{1}{\sqrt{k_x}} \sin \sqrt{k_x} \mathcal{L} & 0 & 0 & \frac{1}{\rho k_x} (1 - \cos \sqrt{k_x} \mathcal{L}) \\ -\sqrt{k_x} \sin \sqrt{k_x} \mathcal{L} & \cos \sqrt{k_x} \mathcal{L} & 0 & 0 & \frac{1}{\rho \sqrt{k_x}} \sin \sqrt{k_x} \mathcal{L} \\ 0 & 0 & \cosh \sqrt{k_y} \mathcal{L} & \frac{1}{\sqrt{k_y}} \sinh \sqrt{k_y} \mathcal{L} & 0 \\ 0 & 0 & \sqrt{k_y} \sinh \sqrt{k_y} \mathcal{L} & \cosh \sqrt{k_y} \mathcal{L} & 0 \\ 0 & 0 & 0 & 0 & 1 \end{pmatrix} \begin{pmatrix} x_0 \\ x'_0 \\ y_0 \\ y'_0 \\ \frac{\delta p}{p} \end{pmatrix}$$

If $0 \leq n \leq 1$:

The dipole is focusing in both planes.

$$\begin{pmatrix} x \\ x' \\ y \\ y' \\ \frac{\delta p}{p} \end{pmatrix} = \begin{pmatrix} \cos \sqrt{k_x} \mathcal{L} & \frac{1}{\sqrt{k_x}} \sin \sqrt{k_x} \mathcal{L} & 0 & 0 & \frac{1}{\rho k_x} (1 - \cos \sqrt{k_x} \mathcal{L}) \\ -\sqrt{k_x} \sin \sqrt{k_x} \mathcal{L} & \cos \sqrt{k_x} \mathcal{L} & 0 & 0 & \frac{1}{\rho \sqrt{k_x}} \sin \sqrt{k_x} \mathcal{L} \\ 0 & 0 & \cos \sqrt{k_y} \mathcal{L} & \frac{1}{\sqrt{k_y}} \sin \sqrt{k_y} \mathcal{L} & 0 \\ 0 & 0 & -\sqrt{k_y} \sin \sqrt{k_y} \mathcal{L} & \cos \sqrt{k_y} \mathcal{L} & 0 \\ 0 & 0 & 0 & 0 & 1 \end{pmatrix} \begin{pmatrix} x_0 \\ x'_0 \\ y_0 \\ y'_0 \\ \frac{\delta p}{p} \end{pmatrix}$$

If $n \geq 1$:

The dipole is horizontally defocusing and vertically focusing.

$$\begin{pmatrix} x \\ x' \\ y \\ y' \\ \frac{\delta p}{p} \end{pmatrix} = \begin{pmatrix} \cosh \sqrt{k_x} \mathcal{L} & \frac{1}{\sqrt{k_x}} \sinh \sqrt{k_x} \mathcal{L} & 0 & 0 & \frac{1}{\rho k_x} (1 - \cosh \sqrt{k_x} \mathcal{L}) \\ \sqrt{k_x} \sinh \sqrt{k_x} \mathcal{L} & \cosh \sqrt{k_x} \mathcal{L} & 0 & 0 & \frac{1}{\rho \sqrt{k_x}} \sinh \sqrt{k_x} \mathcal{L} \\ 0 & 0 & \cos \sqrt{k_y} \mathcal{L} & \frac{1}{\sqrt{k_y}} \sin \sqrt{k_y} \mathcal{L} & 0 \\ 0 & 0 & -\sqrt{k_y} \sin \sqrt{k_y} \mathcal{L} & \cos \sqrt{k_y} \mathcal{L} & 0 \\ 0 & 0 & 0 & 0 & 1 \end{pmatrix} \begin{pmatrix} x_0 \\ x'_0 \\ y_0 \\ y'_0 \\ \frac{\delta p}{p} \end{pmatrix}$$

Pure dipole

- This means, absence of index, $n = -\frac{\rho}{B_y} \frac{\partial B_y}{\partial x} = 0$, “parallel gap” dipole.
- Given that the field is constant over the all beam region, then the trajectory is an arc of a *circle*, with length $\mathcal{L} = \rho\alpha$, with α the deviation in the dipole.
- On the other hand, as to the $[T_{34}]$ term of the matrix, $\mathcal{L} \times \frac{\sin \sqrt{k_y} \mathcal{L}}{\sqrt{k_y} \mathcal{L}} \xrightarrow{n \rightarrow 0} \mathcal{L} = \rho\alpha$
- So that the matrix transport obtained earlier,

$$\begin{pmatrix} x \\ x' \\ y \\ y' \\ \delta p/p \end{pmatrix} = \begin{pmatrix} \cos \sqrt{k_x} \mathcal{L} & \frac{1}{\sqrt{k_x}} \sin \sqrt{k_x} \mathcal{L} & 0 & 0 & \frac{1}{\rho k_x} (1 - \cos \sqrt{k_x} \mathcal{L}) \\ -\sqrt{k_x} \sin \sqrt{k_x} \mathcal{L} & \cos \sqrt{k_x} \mathcal{L} & 0 & 0 & \frac{1}{\rho \sqrt{k_x}} \sin \sqrt{k_x} \mathcal{L} \\ 0 & 0 & \cos \sqrt{k_y} \mathcal{L} & \frac{1}{\sqrt{k_y}} \sin \sqrt{k_y} \mathcal{L} & 0 \\ 0 & 0 & -\sqrt{k_y} \sin \sqrt{k_y} \mathcal{L} & \cos \sqrt{k_y} \mathcal{L} & 0 \\ 0 & 0 & 0 & 0 & 1 \end{pmatrix} \begin{pmatrix} x_0 \\ x'_0 \\ y_0 \\ y'_0 \\ \delta p/p \end{pmatrix}$$

simplifies into

$$\begin{pmatrix} x \\ x' \\ y \\ y' \\ \delta p/p \end{pmatrix} = \begin{pmatrix} \cos \alpha & \rho \sin \alpha & 0 & 0 & \rho(1 - \cos \alpha) \\ -\frac{1}{\rho} \sin \alpha & \cos \alpha & 0 & 0 & \sin \alpha \\ 0 & 0 & 1 & \rho\alpha & 0 \\ 0 & 0 & 0 & 1 & 0 \\ 0 & 0 & 0 & 0 & 1 \end{pmatrix} \begin{pmatrix} x_0 \\ x'_0 \\ y_0 \\ y'_0 \\ \delta p/p \end{pmatrix}$$

Vertically, the sector dipole is equivalent to a drift with length $L = \rho\alpha$.

3.7 Electrostatic cylindrical lenses

Introduction to cylindrical potentials and calculation methods

Maxwell's equations of concern with electric fields :

- (1) $\text{curl} \vec{E} = -\frac{\partial \vec{B}}{\partial t}$ is zero \leftarrow static fields

Hence \vec{E} derives from a gradient ($\text{curl}(\text{grad}) \equiv 0$), $\vec{E} = -\text{grad}V$

- (2) $\text{div} \vec{E} = 0$

A consequence of (1) and (2) is,

$$\text{div grad}V = \Delta V = \nabla^2 V = 0, \text{ the Laplace equation.}$$

We focus on cylindrically symmetric type of electrostatic lens, since cylindrical lenses have focusing properties of interest in beam transport.

In cylindrical coordinates (r, θ, s) , the Laplacian writes

$$\nabla^2 V = \frac{1}{r} \frac{\partial}{\partial r} \left(r \frac{\partial V}{\partial r} \right) + \frac{1}{r^2} \frac{\partial^2 V}{\partial \theta^2} + \frac{\partial^2 V}{\partial s^2} = 0$$

Since we are assuming cylindrical symmetry, i.e. V does not change with θ , then $\frac{\partial V}{\partial \theta} = 0$,
 $\frac{\partial^2 V}{\partial \theta^2} = 0$,

and as a consequence the Laplace equation reduces to :

$$\frac{1}{r} \frac{\partial}{\partial r} \left(r \frac{\partial V}{\partial r} \right) + \frac{\partial^2 V}{\partial s^2} = 0$$

Unipotential lens (Einzel lens)

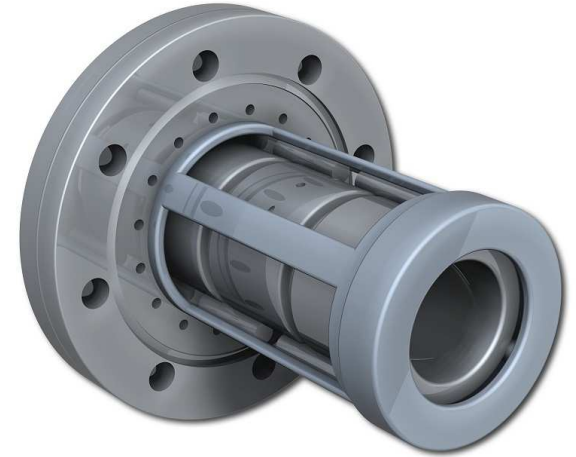

- An approach to finding approximate solutions to this differential equation, is to develop the potential in Taylor series from the axis.

This approach is of particular interest when using numerical methods to calculate particle motion, it is an easy way to get the potential at non-zero radius, and hence the field and force that apply on the particle, starting from the mere description of the potential on the lense axis.

Doing so means that

$$\frac{1}{r} \frac{\partial}{\partial r} \left(r \frac{\partial V}{\partial r} \right) + \frac{\partial^2 V}{\partial s^2} = 0 \quad (1)$$

should satisfy the following Taylor developement, with even dependence on the coordinate r , since $V(-r) = V(r)$ due to the θ -invariance of V

$$V = \sum_{i=0}^{\infty} a_{2n}(s) r^{2n} \quad (2)$$

From (1) and (2) such is the case if

$$a_{2n}(s) = -\frac{1}{(2n)^2} a''_{2n-2}(s) \quad [(\cdot)' = \partial(\cdot)/\partial s]$$

In other words,

$$\boxed{V(\mathbf{s}, \mathbf{r}) = V_{r=0}(\mathbf{s}) - \frac{1}{2^2} V''_{r=0}(\mathbf{s}) \mathbf{r}^2 + \frac{1}{(2 \cdot 4)^2} V^{(4)}_{r=0}(\mathbf{s}) \mathbf{r}^2 + \dots}$$

in which expression $V_{r=0}(s)$ is the potential along the lens axis.

EXERCISE

Given the expression of $V(s,r)$ under the form of a Taylor development,

$$V = \sum_{i=0}^{\infty} a_{2n}(s)r^{2n} \quad (2)$$

show that

$$\frac{1}{r} \frac{\partial}{\partial r} \left(r \frac{\partial V}{\partial r} \right) + \frac{\partial^2 V}{\partial s^2} = \mathbf{0} \quad (1)$$

entails

$$a_{2n}(s) = -\frac{1}{(2n)^2} a''_{2n-2}(s)$$

Electrostatic field

- Particle motion can be computed if the electric field $\vec{E}(s, r)$ is known, since it determines the strength applied on the charge, $\vec{F} = q \vec{E}$.

As a matter of fact, numerical methods like stepwise ray-tracing (stepwise resolution of Lorentz equation, using for instance Runge-Kutta method) are often used, due to the complexity of the motion in electrostatic elements.

By virtue of Maxwell's equation : $\vec{E} = -\text{grad}V$
 the longitudinal and radial field components : $E_s(s, r), E_r(s, r)$
 can be obtained by differentiation of the potential,

$$E_s(s, r) = -\frac{\partial V(s, r)}{\partial s}, \quad E_r(s, r) = -\frac{\partial V(s, r)}{\partial r}$$

In cylindrical lenses for instance, $V(s, r)$ can then be drawn from a Taylor expansion in r with respect to the optical axis as seen earlier,

$$V(s, r) = V_{r=0}(s) - \frac{1}{4} V''_{r=0}(s) r^2 + \frac{1}{64} V^{(4)}_{r=0}(s) r^4 + \dots$$

$$\left| \begin{array}{l} \text{grad}_r V = \frac{\partial V}{\partial r} \\ \text{grad}_\theta V = \frac{1}{r} \frac{\partial V}{\partial \theta} \\ \text{grad}_s V = \frac{\partial V}{\partial s} \end{array} \right.$$

Careful though with manipulation of Taylor-series based approximations of fields, potentials : it (may) work, yet within limits, which depend on the form of the $\partial V / \partial s$: the series convergences, i.e., the series developement of the potential can only bring a solution, within some radius of convergence r_c ($r < r_c$).

- A different approach consists in finding a solution to the differential equation, when the symmetries allow it.

We assume again cylindrical symmetry, and thus consider the simplified form of the Laplace equation (the same as earlier, we just developed the first term in that equation)

$$\frac{\partial^2 V}{\partial r^2} + \frac{1}{r} \frac{\partial V}{\partial r} + \frac{\partial^2 V}{\partial s^2} = 0$$

A classical method of separation of variables can be applied to this type of differential equation, namely, we stipulate that $V(r, z) = \mathcal{R}(r)\mathcal{S}(s)$

This transforms the equation above into

$$\frac{1}{\mathcal{R}} \left(\frac{\partial^2 \mathcal{R}}{\partial r^2} + r \frac{\partial \mathcal{R}}{\partial r} \right) = -\frac{1}{\mathcal{S}} \frac{\partial^2 \mathcal{S}}{\partial s^2}$$

This equality has to be satisfied whatever r and s , so that one can write - this is the principle of the method,

$$\frac{1}{\mathcal{R}} \frac{\partial^2 \mathcal{R}}{\partial r^2} + \frac{1}{r\mathcal{R}} \frac{\partial \mathcal{R}}{\partial r} = -k^2 \quad \text{on the one hand,}$$

$$\frac{1}{\mathcal{S}} \frac{\partial^2 \mathcal{S}}{\partial s^2} = +k^2 \quad \text{on the other hand,}$$

with k a constant to be determined.

The solution to this system is

$$\begin{cases} \mathcal{R} = A I_0(kr) + B K_0(kr) \\ \mathcal{S} = C \cos k(s - s_0) \end{cases}$$

in which I_0 and K_0 are modified Bessel functions of the second kind, A , B and C are arbitrary constants to be determined from the particular geometry of the problem.

Example : the bi-potential cylindrical lens

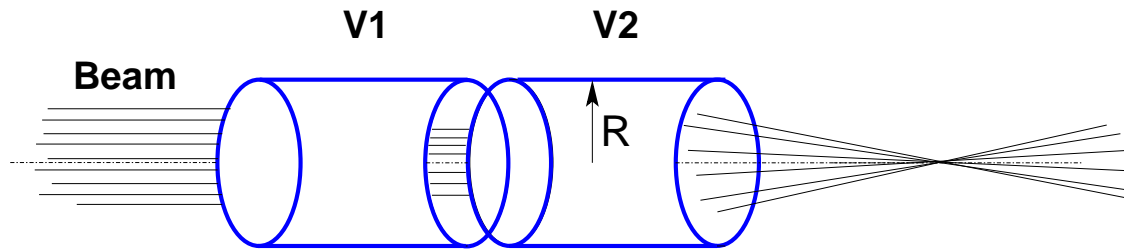

In the possible solution in r the $K_0(r)$ term is removed because non-physical, $K_0(r) \xrightarrow{r \rightarrow \infty} 0$.

We will not go into the details of the resolution of this system. The general lines are the following :

- the origin is taken at the slot between the two tubes
 - a potential of the form $\mathcal{V}(s, r) = V - \frac{V_1 + V_2}{2}$ is sought,
- with the virtue of satisfying

$$\begin{aligned} \mathcal{V}(s, r) &\xrightarrow{s \rightarrow -\infty} -\frac{V_2 - V_1}{2}, \\ \mathcal{V}(s, r) &\xrightarrow{s \rightarrow +\infty} +\frac{V_2 - V_1}{2}. \end{aligned}$$

Looking for a solution of the form

$$\mathcal{V}(s, r) = V - \frac{V_1 + V_2}{2} = \sum_k A(k) I_0(kr) \sin ks$$

it can be shown that

$$\sum_k A(k) k I_0(kr) = \frac{V_2 - V_1}{\pi} \quad \text{and thus} \quad \mathcal{V}(s, r) = \frac{V_1 + V_2}{2} + \frac{V_2 - V_1}{2} \int_0^\infty \frac{\sin ks}{k I_0(kr)} dk$$

One way to end up with that is to compute this integral numerically.

However a practically identical, simpler, good approximation to the function above, generally used in beam transport to simulate the bi-potential lens because it is easier to manipulate, is :

$$\mathcal{V}(s, r) = \frac{V_1 + V_2}{2} + \frac{V_2 - V_1}{2} \tanh \frac{\omega s}{R} \quad \text{with } \omega = 1.318, \quad \mathbf{R \text{ the inner radius of the tube}}$$

When the distance between the two cylinders, say d , is not negligible, the solution of the differential equation is

$$\mathcal{V}(s, r) = \frac{V_1 + V_2}{2} + \frac{V_2 - V_1}{\pi} \int_0^\infty \frac{\sin ks}{k I_0(kr)} \frac{\sin kd}{kd} dk$$

and a good approximation writes

$$\mathcal{V}(s, r) = \frac{V_1 + V_2}{2} + \frac{V_2 - V_1}{4\omega d/R} \log \frac{\cosh \omega(s + d)/R}{\cosh \omega(s - d)/R}$$

Einzel lens

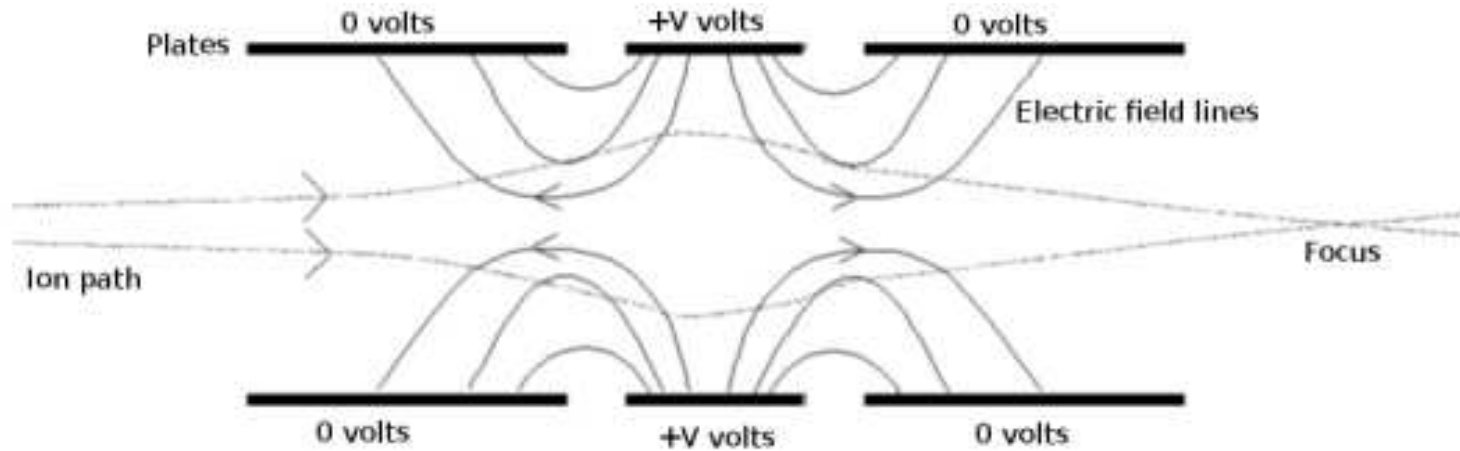

It consists of three or more sets of cylindrical or rectangular tubes in series along an axis.

It is used for beam focusing, sometimes including beam purification : one ion specie focussed while polluting other species are deviated away from the lens axis.

Potentials on the first and on the last electrode are identical, hence the Einzel lens focuses without changing the energy of the beam.

For this reason it is often called **the “unipotential lens”**.

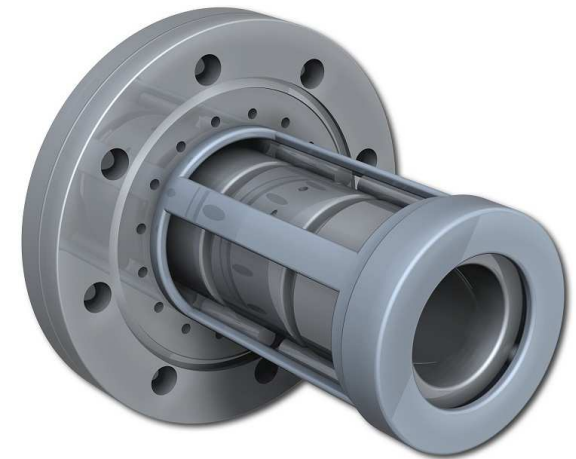

Let the length of the first, second, third electrodes be respectively L_1, L_2, L_3 , and the distance between the electrodes d . The total length of the lens is $L_1 + L_2 + L_3 + 2d$. Let the two potentials applied on the electrodes be $V1$ and $V2$. The inner radius is R_0 .

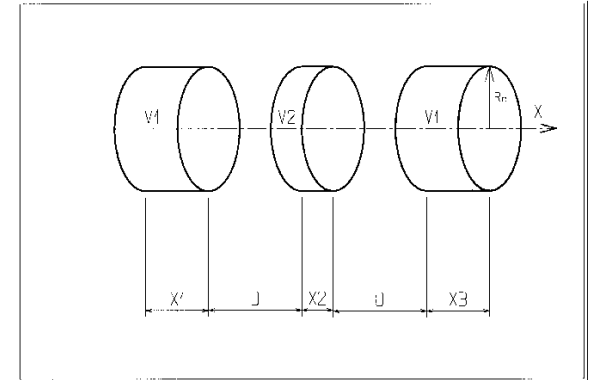

Three-electrode cylindrical unipotential lens.

Thus, a model for the electrostatic potential along the axis is

$$\mathcal{V}(s) = \frac{V2 - V1}{2\omega d} \left[\ln \frac{\cosh \frac{\omega \left(s + \frac{L_2}{2} + d \right)}{R_0}}{\cosh \frac{\omega \left(s + \frac{L_2}{2} \right)}{R_0}} + \ln \frac{\cosh \frac{\omega \left(s - \frac{L_2}{2} - d \right)}{R_0}}{\cosh \frac{\omega \left(s - \frac{L_2}{2} \right)}{R_0}} \right]$$

where s is the distance from the center of the central electrode, and $\omega = 1,318$.

The field in the lens derives from the Taylor series derived from the potential,

$$\begin{cases} E_s(s, r) = -\frac{\partial V(s, r)}{\partial s} = E_s(s, 0) - \frac{r^2}{2^2} \frac{\partial^2 E_s}{\partial s^2}(s, 0) + \frac{r^4}{(2 \cdot 4)^2} \frac{\partial^4 E_s}{\partial s^4}(s, 0) \\ E_r(s, r) = -\frac{\partial V(s, r)}{\partial r} = -\frac{r}{2^2} \frac{\partial E_s}{\partial s}(s, 0) + \frac{r^3}{(2 \cdot 4)^2} \frac{\partial^3 E_s}{\partial s^3}(s, 0) - \frac{r^5}{(2 \cdot 4 \cdot 6)^2} \frac{\partial^5 E_s}{\partial s^5}(s, 0) \end{cases}$$

Note that E_s only is non-zero on axis, the radial component $E_r(s, r = 0)$ is zero on axis.

3.8 Electrostatic prism

Prisms are bending elements. They are used in energy analyzers, in mass spectrometers in combination with sector dipole magnets.

- Simple prisms are
 - parallel plate condenser, particles move on parabolas, limited to small deflections
 - toroidal deflectors, the main path is a circle following the middle equipotential.
- A charge q with energy U in a toroidal deflector follows a radius r_0 such that

$$\frac{2U_0}{r_0} = -qE$$

with $v_0 = (2U_0/m)^{1/2}$ being the velocity of the particle, m is the relativistic mass.

The field strength E on the middle equipotential has to be adjusted so to fulfill this rule.

Similarly with what we have seen with magnetic dipoles, we are interested in fields of the form

$$E_r(r, y = 0) = E_{r=0, y=0} \left[1 + n_1 \frac{r - r_0}{r_0} + n_2 \left(\frac{r - r_0}{r_0} \right)^2 + \dots \right]$$

3.9 Combined $\vec{E} + \vec{B}$ optical elements

Wien filter

3.10 Combined $\vec{E} + \vec{B}$ optical elements

“Zero-chromaticity” quadrupole

4 Treatment of charged particle motion in optical ensembles

Now we have gone through general considerations concerning the treatment of optical elements, we have the means to assemble these into optical structures : series of such elements, thus constituting so-called “beam lines” and other “accelerator lattice cells”.

We will develop the methods assuming magnetic elements, for simplicity : constant $|\vec{v}|$, constant mass.

4.1 General developement of mid-plane symmetry fields

Optical structures as “beam lines”, “accelerator cells” are comprised of successions of optical elements as bending magnets, quadrupoles, higher order multipole lenses like sextupoles, octupoles, etc.

For practical reasons all these elements are generally disposed in an “horizontal plane”, meaning actually :

the mid-plane of all these optical elements coincide with a common, so-called “horizontal plane”.

This “horizontal plane” may sometimes not be horizontal, confer LHC, microtron injectors... What matters most is the fact that this reference plane is common to all optical elements that constitute the ensemble.

For that reason, it is often referred to, instead, as the “bend plane”, or “median plane”.

In order to describe particle motion in optical structures, it is useful to define a single type of reference frame, proper to be used in any of the individual optical elements.

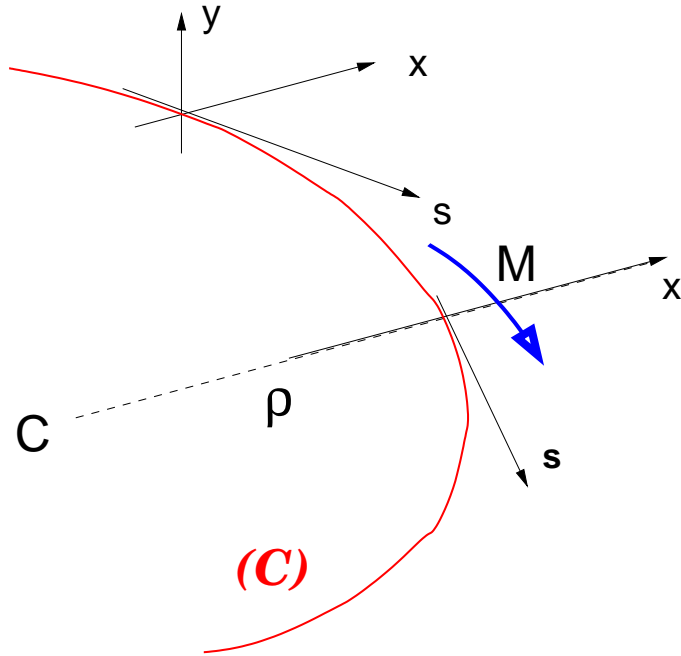

(O_s) lies in the reference trajectory plane, tangent to the trajectory at point M_0 projection of M , on C ,
 (O_x) lies in the reference trajectory plane, normal to C at M_0 ,
 (O_y) is normal to the reference trajectory plane

The reference frame is built on a “reference trajectory” (C) taken in the “horizontal plane” and associated with a “reference momentum” p :

- in a field-free section, (C) is straight line,
- in multipole lenses, (C) is a straight line : the multipole axis,
- in a bending magnet, (C) is an arc of a circle with curvature radius $\rho = \frac{p}{qB} = B\rho/B$, center of curvature at C ,
 (s, x, y) can be considered as a cylindrical system (s, r, θ) with

$$r = \rho + x, \quad \theta = s/\rho$$

Antisymmetry plane

- In *upright* magnetic elements the median plane ($y = 0$) is an antisymmetry plane

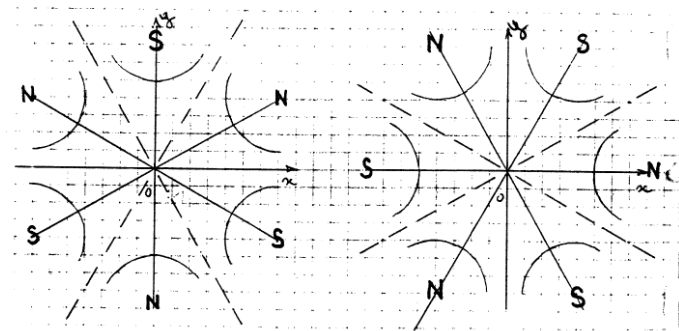
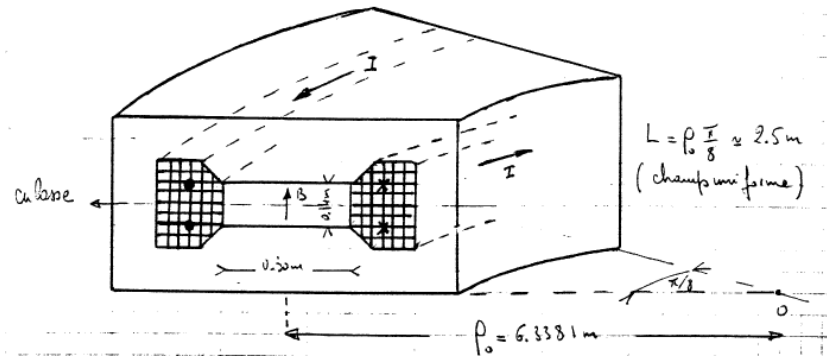

not in “skew” elements

$y = 0$ being antisymmetry plane, one has :

$$B_s(s, x, -y) = -B_s(s, x, y) \quad (\rightarrow B_s = 0 \text{ at } y = 0)$$

$$B_x(s, x, -y) = -B_x(s, x, y) \quad (\rightarrow B_x = 0 \text{ at } y = 0)$$

$$B_y(s, x, -y) = B_y(s, x, y)$$

meaning that

$B_s(s, x, y)$ is an odd function of y ,
 $B_x(s, x, y)$ is an odd function of y ,
 $B_y(s, x, y)$ is an even function of y .

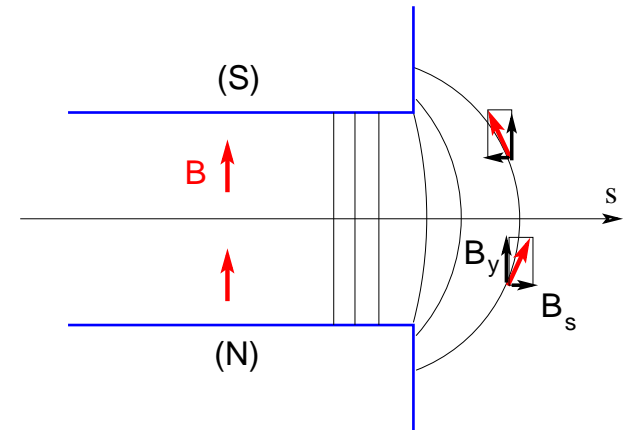

Development of the field

- We need to find a convenient way of expressing \vec{B} components

$$B_s(s, x, y), \quad B_x(s, x, y), \quad B_y(s, x, y),$$

and then inject them into the equation of motion,

$$\vec{F} = d\vec{p}/dt$$

- Taylor expansions in x and z with respect to the reference trajectory are an appropriate way, assuming that particle motion stays confined in the vicinity of that reference (fortunately accelerators have a finite aperture beam pipe !).

Taylor expansions of the field compents write :

$$B_s(s, x, y) = \sum_{i,k=0}^{\infty} x^i y^{2k+1} C_{s,i,k}(s) \quad (\text{odd dependence in } y)$$

$$B_x(s, x, y) = \sum_{i,k=0}^{\infty} x^i y^{2k+1} C_{x,i,k}(s) \quad (\text{odd dependence in } y)$$

$$B_y(s, x, y) = \sum_{i,k=0}^{\infty} x^i y^{2k} C_{y,i,k}(s) \quad (\text{even dependence in } y)$$

where the $C_{s,i,k}(s)$, $C_{x,i,k}(s)$, $C_{y,i,k}(s)$ have been introduced to simplify notations, and can be built up explicitly from the derivatives, respectively,

$$\left. \frac{\partial^{i+k} B_s}{\partial x^i \partial y^k} \right|_{x=0, y=0}, \quad \left. \frac{\partial^{i+k} B_x}{\partial x^i \partial y^k} \right|_{x=0, y=0}, \quad \left. \frac{\partial^{i+k} B_y}{\partial x^i \partial y^k} \right|_{x=0, y=0}$$

The coefficients C_s, C_x, C_y in these Taylor series can be explicitated using Maxwell equations.

They are *linked* by Maxwell equations :

$$\vec{\text{curl}}\vec{B} = 0 \Rightarrow \begin{cases} \frac{\partial B_x}{\partial y} - \frac{\partial B_y}{\partial x} = 0 \\ \frac{\rho}{\rho+x} \frac{\partial B_y}{\partial s} - \frac{\partial B_s}{\partial y} = 0 \\ \frac{\partial B_s}{\partial x} + \frac{B_s}{\rho+x} + \frac{\rho}{\rho+x} \frac{\partial B_x}{\partial s} = 0 \end{cases}$$

$$\text{div}\vec{B} = 0 \Rightarrow \frac{\rho}{\rho+x} \frac{\partial B_s}{\partial s} + \frac{B_x}{\rho+x} + \frac{\partial B_x}{\partial x} + \frac{\partial B_y}{\partial y} = 0$$

• **Bringing into these equations the previous $B_s(s, x, y), B_x(s, x, y), B_y(s, x, y)$, one gets recursive relations between the Taylor series coefficients C_s, C_x, C_y ,**

- $dC_{y_{i,k}}/ds = (2k + 1)(Cs_{i,k} + Cs_{i-1,k}/\rho),$
- $(i + 1)C_{y_{i+1,k}} = (2k + 1)Cx_{i,k},$
- $dCx_{i,k}/ds = (i + 1)(Cs_{i+1,k} + Cs_{i-1,k}/\rho),$
- $2(k + 1)(C_{y_{i,k+1}} + C_{y_{i-1,k+1}}/\rho) + (i + 1)(Cx_{i,k+1} + Cx_{i,k}/\rho) + dCs_{i,k}/ds$

Particular notations introduced at that point, proper to beam optics, are the following :

- $h = h(s) = \frac{1}{\rho(s)} = \frac{-q}{p_0} B_y(s)|_{x=0,y=0} = -\frac{B\rho}{B_y(s)}$

(remember that $B\rho = p_0/q$, **rigidity**, is a **property of the particle**)

- The first order radial derivative of the field, $\frac{\partial B_y}{\partial x}$ is replaced, noting $n = n(s) = \frac{-1}{hB_y|_{x=0,y=0}} \frac{\partial B_y}{\partial x} \Big|_{x=0,y=0}$ the **field index**, a “quadrupole term”

- The second order radial derivative of the field, $\frac{\partial^2 B_y}{\partial x^2}$ is replaced, noting $n' = n'(s) = \frac{1}{2h^2 B_y|_{x=0,y=0}} \frac{\partial^2 B_y}{\partial x^2} \Big|_{x=0,y=0}$ a “sextupole term”.

A few pages of algebra, accounting for these notations and for the earlier recurrent relations, then yield the following **general developement of mid-plane symmetry fields** :

$$\begin{cases} B_s(s) = h^{-1} B_{y0} [h'y - (n'h^2 + 2nhh' + hh')xy + \dots] \\ B_x(s) = h^{-1} B_{y0} [-nh^2y + 2n'h^3xy + \dots] \\ B_y(s) = h^{-1} B_{y0} [h - nh^2x + n'h^3x^2 - \frac{1}{2}(h'' - nh^3 + 2n'h^3)y^2 + \dots] \end{cases}$$

The equations of motion

Now that we have nice expressions for the field components, we can apply the methods we have seen earlier in deriving particle motion in lenses.

We will not detail these lengthy calculations here, we will just summarize it - in a mere two pages !

- Back to the reference frame introduced earlier :

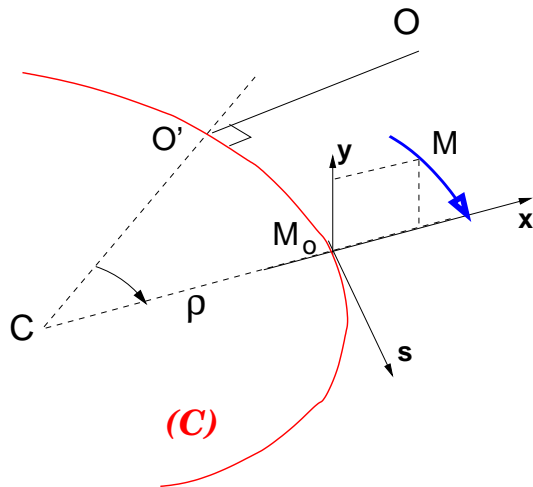

- O is a (arbitrary) reference origin in the laboratory
- O' is the projection of O on (C) , origin of curvilinear distance s
- particle position M at time t and distance s is given by $O\vec{M} = O\vec{M}_0 + x\vec{x} + y\vec{y}$, with M_0 projection of M on (C)
- $\vec{s} = \frac{dO'M_0}{ds}$ lies in the reference trajectory plane, tangent to the trajectory at point M_0 ,
- \vec{x} lies in the reference trajectory plane, normal to (C) at M_0 ,
- \vec{y} is normal to the reference trajectory plane

- The motion of the particle satisfies the following equations :

$\dot{s} = \frac{ds}{dt}$ is the velocity of the projection M_0 of M on (C)

$$\begin{aligned} \frac{d\vec{s}}{ds} &= -\frac{\vec{x}}{\rho} = -h\vec{x} \\ \frac{d\vec{x}}{ds} &= \frac{\vec{s}}{\rho} = h\vec{s} \\ \frac{d\vec{y}}{ds} &= 0 \end{aligned}$$

$$\begin{aligned} \frac{d\vec{s}}{dt} &= -\frac{\dot{s}}{\rho}\vec{x} = -h\dot{s}\vec{x} \\ \frac{d\vec{x}}{dt} &= \frac{\dot{s}}{\rho}\vec{s} = h\dot{s}\vec{s} \\ \frac{d\vec{y}}{dt} &= 0 \end{aligned}$$

EXERCISE**Show that**

$$|\vec{v}| = \dot{s}(1 + hx)\vec{s} + \dot{x}\vec{x} + \dot{z}\vec{z}$$

• **Given these ingredients, and in addition**

- **accounting for the field developments derived in the previous section,**
- **introducing further, $|\vec{v}| = \dot{s} [(1 + hx)^2 + x'^2 + y'^2]^{1/2}$**
- **and $p = p_0(1 + \delta)$**

then the equation of motion $m \frac{d\vec{v}}{dt} = q \vec{v} \times \vec{B}$ can be developed to 2nd order in the coordinates x, y, δ , into

$$\begin{cases} x'' + (1 - n)h^2x = h\delta + (2n - 1 - n')h^3x^2 + h'xx' + \frac{1}{2}hx'^2 + (2 - n)h^2x\delta \\ \quad + \frac{1}{2}(h'' - nh^3 + 2n'h^3)y^2 + h'yy' - \frac{1}{2}hy'^2 - h\delta^2 \\ y'' + nh^2y = (2n' - n)h^3xy + h'xy' + h'x'y + hx'y' + nh^2y\delta \end{cases}$$

• **These equations simplify when considering “perfect optical elements”, namely optical devices for which it is assumed that B_0, n, h **do not depend on s****
for instance :

- **a bending magnet with constant \vec{B} whatever s, x, y**
- **a quadrupole magnet without fringe field**

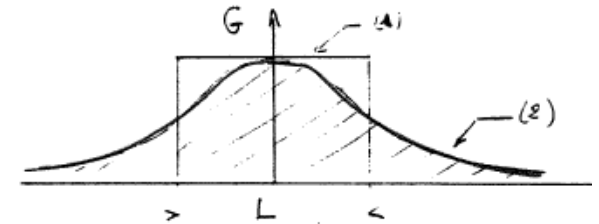

• **However we will focus, in the following, on the **linear motion**, namely, the sole terms of order 0 or 1 in x, y and δ are retained in the equations above.**

In these hypotheses : first order approximation, linear fields, the equations of motion above become

$$\begin{cases} x'' + K_x x = h\delta & (K_x = (1 - n)h^2) \\ y'' + K_y y = 0 & (K_y = nh^2) \end{cases}$$

Transport matrix

As we have seen when studying optical elements : quadrupole, bending magnet, the solutions of

$$\begin{cases} x'' + K_x x = h\delta & (K_x = (1 - n)h^2) \\ y'' + K_y y = 0 & (K_y = nh^2) \end{cases}$$

can be written under matrix form. We will generalize the 2x2 matrix notation introduced there to 5x5 matrices so to account for both

- horizontal motion, described by its components x and x'
- vertical motion, described by its components y and y'
- and for the momentum deviation of the particle considered, with respect to the reference momentum, $\delta = (p - p_0)/p_0$

$$\begin{pmatrix} x \\ x' \\ y \\ y' \\ \delta \end{pmatrix} = \begin{pmatrix} T_{11} & T_{12} & 0 & 0 & T_{16} \\ T'_{11} & T'_{12} & 0 & 0 & T'_{16} \\ 0 & 0 & T_{33} & T_{34} & 0 \\ 0 & 0 & T'_{33} & T'_{34} & 0 \\ 0 & 0 & 0 & 0 & 1 \end{pmatrix} \begin{pmatrix} x_0 \\ x'_0 \\ y_0 \\ y'_0 \\ \delta \end{pmatrix}$$

A property of the determinant of the transport matrix

- From the earlier matrix transform we draw

$$x' = T'_{11}x_0 + T'_{12}x'_0 + T'_{16}\delta$$

Differentiating with respect to x' we then get

$$x'' = T''_{11}x_0 + T''_{12}x'_0 + T''_{16}\delta \quad (a)$$

Introducing $x'' + K_x x = h\delta$ and $x = T_{11}x_0 + T_{12}x'_0 + T_{16}\delta$, one then gets

$$x'' = -K_x T_{11}x_0 - K_x T_{12}x'_0 + (h - K_x T_{16})\delta \quad (b)$$

- Comparing (a) and (b), and by analogy for the vertical coordinates, we deduce :

$$\left\{ \begin{array}{l} T''_{11} = -K_x T_{11} \\ T''_{12} = -K_x T_{12} \\ T''_{16} = -K_x T_{16} + h \\ T''_{33} = -K_y T_{33} \\ T''_{34} = -K_y T_{34} \end{array} \right.$$

- From these relations it results that the derivatives of the determinants of the following three sub-matrices are zero :

$$\begin{pmatrix} T_{11} & T_{12} \\ T'_{11} & T'_{12} \end{pmatrix}, \quad \begin{pmatrix} T_{11} & T_{12} & T_{16} \\ T'_{11} & T'_{12} & T'_{16} \\ 0 & 0 & 1 \end{pmatrix}, \quad \begin{pmatrix} T_{33} & T_{34} \\ T'_{33} & T'_{34} \end{pmatrix}$$

EXERCISE**Using the relations**

$$\begin{cases} T''_{11} = -K_x T_{11} \\ T''_{12} = -K_x T_{12} \\ T''_{16} = -K_x T_{16} + h \\ T''_{33} = -K_y T_{33} \\ T''_{34} = -K_y T_{34} \end{cases}$$

show that the matrices

$$\begin{pmatrix} T_{11} & T_{12} \\ T'_{11} & T'_{12} \end{pmatrix}, \quad \begin{pmatrix} T_{11} & T_{12} & T_{16} \\ T'_{11} & T'_{12} & T'_{16} \\ 0 & 0 & 1 \end{pmatrix}, \quad \begin{pmatrix} T_{33} & T_{34} \\ T'_{33} & T'_{34} \end{pmatrix}, \quad \begin{pmatrix} T_{11} & T_{12} & 0 & 0 & T_{16} \\ T'_{11} & T'_{12} & 0 & 0 & T'_{16} \\ 0 & 0 & T_{33} & T_{34} & 0 \\ 0 & 0 & T'_{33} & T'_{34} & 0 \\ 0 & 0 & 0 & 0 & 1 \end{pmatrix}$$

all have zero-derivative determinant.

As a consequence, the determinant of the transport matrix is constant. Its value can be determined from the limit case :

If $s \longrightarrow 0$, then $[T] \longrightarrow I$, hence

$$\det[T] = 1.$$

This property stems from “**Liouville’s theorem**”,

this is a particular form that Liouville’s theorem takes, in linear transport.

We will introduce Liouville’s theorem in the next section and come back to this property.

So, to conclude this section, we observe that :

A beam line, i.e. a succession of optical elements : drifts, lenses, bending elements, is represented to first order in the components, x, x', \dots by a transport matrix which satisfies

$$\begin{cases} X = T \times X_0 \\ \det(T) = 1 \end{cases} \quad \text{with} \quad X = \begin{pmatrix} x \\ x' \\ y \\ y' \\ \delta \end{pmatrix}$$

Given that the horizontal plane and the vertical plane are decoupled (no mixed terms in the differential equations) it is possible to independently consider, work on, each of the sub-spaces and related sub-matrices :

$$\begin{pmatrix} x \\ x' \\ \delta \end{pmatrix} = \begin{pmatrix} T_{11} & T_{12} & T_{16} \\ T_{21} & T_{22} & T_{26} \\ 0 & 0 & 1 \end{pmatrix} \begin{pmatrix} x_0 \\ x'_0 \\ \delta \end{pmatrix}$$

and

$$\begin{pmatrix} y \\ y' \end{pmatrix} = \begin{pmatrix} T_{33} & T_{34} \\ T_{43} & T_{44} \end{pmatrix} \begin{pmatrix} y_0 \\ y'_0 \end{pmatrix}$$

with each sub-matrix having determinant 1.

5 Notions of phase space, emittance

5.1 Phase space

- A linear source of rays is considered :

- it extends over $[AA']$ at some location s along the longitudinal coordinate axis,
at all $x \in [A, A']$ rays are emitted,

- the angular aperture of the emission at each individual source is fixed,

$$\text{say } \text{Max} \left(\frac{dx}{ds} \right) = x'_{\text{max}},$$

- The beam can then be represented in a 2-D space with

x in abscissa and x' in ordinate,

a so-called **phase-space representation** of the beam.

The phase space : (x, x') is a Cartesian space with axis $x, x' = \frac{dx}{ds}$.

In the “local phase space at abscissa s ”, or equivalently, at time t , a particle is represented by a point.

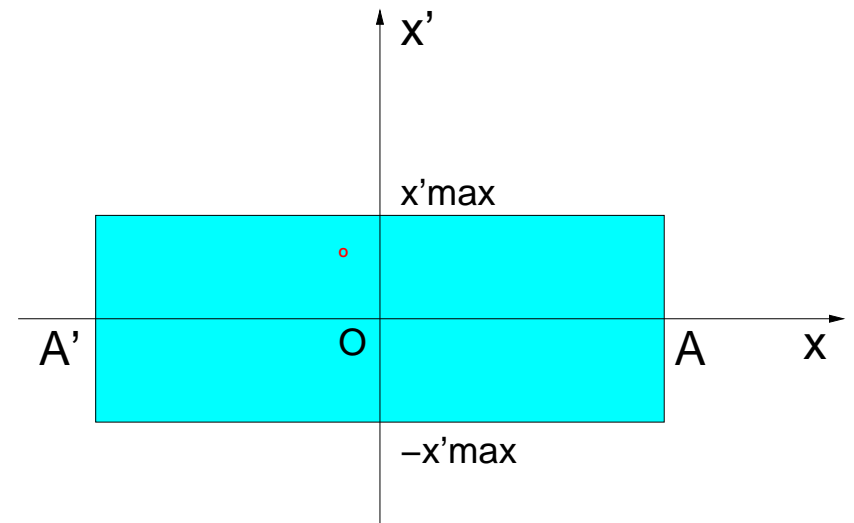
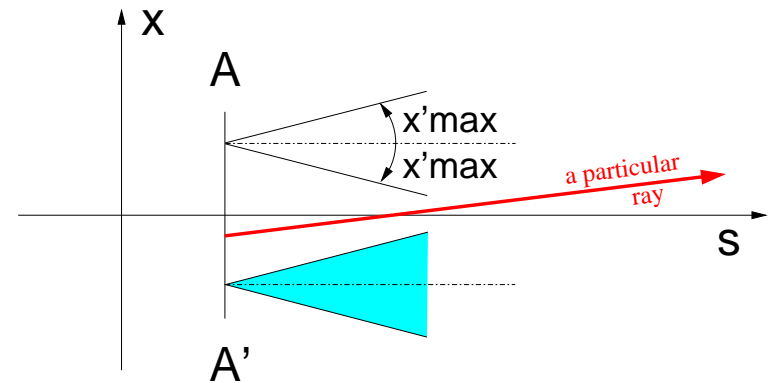

- The area in phase-space occupied by the beam (say, the area of the domain \mathcal{D} below) is known as the “phase space extent” or “**emittance**” of the beam.

It is measured in **meter** \times **radian**.

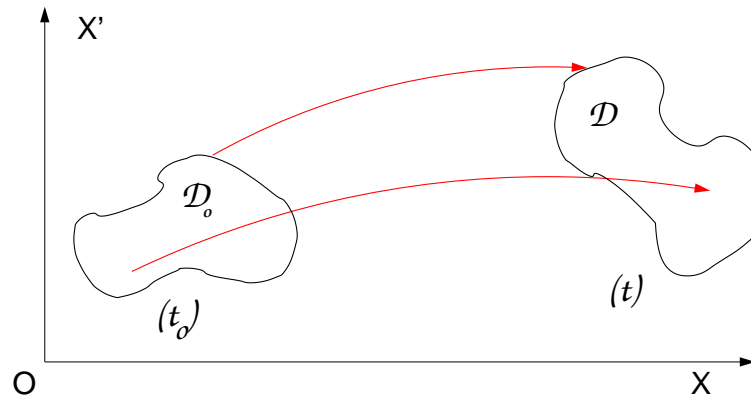

With time, or equivalently as the beam proceeds in distance s , the shape of the domain \mathcal{D} changes.

- Note that a *line* in the local phase space (as the one that circumscribes the domains above) represents
 - either a family of particles all “photographed” at the same location s along the accelerator or beam line
 - or, for instance in a circular accelerator, the successive states of a single particle “photographed” upon successive passages at location s (at periodic intervals of time $t, t + T, t + 2T, \dots$).
 The latter is also known as the “**particle trajectory in phase space**”.

What is the interest of phase space ? (1/2)

1/ The equation of motion of the mechanics are of second order :

$$\frac{dm\vec{v}}{dt} = \vec{F}$$

that is to say, future motion depends

- (i) on the strengths introduced
- (ii) on 2 initial conditions which are the *initial position* and the *initial velocity*.

As a consequence there can not be coincidence at the same time t (or at the same location s) between 2 trajectories with different initial conditions.

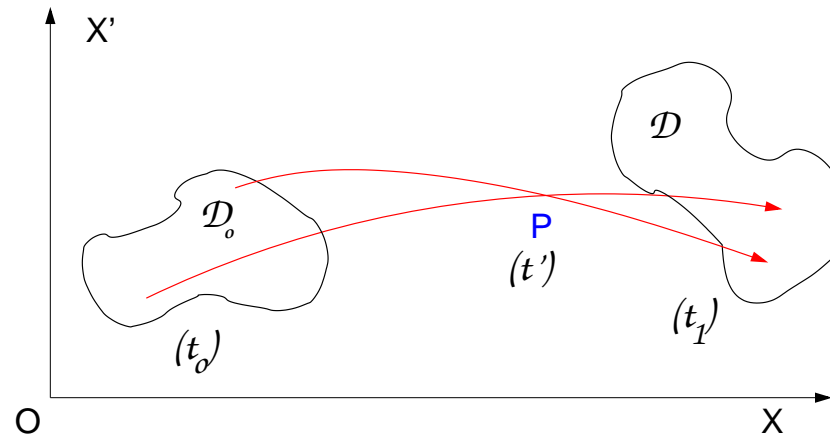

This configuration is not possible
as it would mean, **at point P (at time t')**,
2 different further behavior
given **2 identical initial conditions**.

What is the interest of phase space ? (2/2)

2/ Liouville's theorem

**A conservative system,
i.e., a system subject to strengths that do not
work, is such that :**

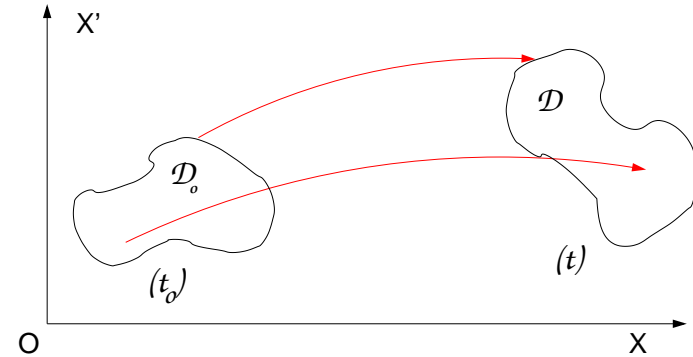

$$\text{Area of domain } \mathcal{D}, \text{ at time } t = \text{Area of domain } \mathcal{D}_0, \text{ at time } t_0$$

This can be expressed mathematically in the following way.

Let $\mathcal{A}_x(s_0) = \int \int dx_0 dx'_0$ be an element of surface in domain \mathcal{D}_0 at location s_0 .

The transform of that surface element into domain \mathcal{D} at location s writes

$$\mathcal{A}_x(s) = \int \int dx dx' = \int \int \frac{D(x, x')}{D(x_0, x'_0)} dx_0 dx'_0$$

whereas the Jacobian of the transform satisfies

$$\frac{D(x, x')}{D(x_0, x'_0)} = \begin{vmatrix} \partial x / \partial x_0 & \partial x / \partial x'_0 \\ \partial x' / \partial x_0 & \partial x' / \partial x'_0 \end{vmatrix} = 1, \quad \text{by virtue of Liouville's theorem}$$

Hence,
$$\boxed{\mathcal{A}_x(s) = \mathcal{A}_x(s_0)}.$$

Transformation of the emittance by a conservative optical system

Beam physicists are not so fond of distorted phase space domains, they are preferred elliptical domains, an area with elliptical limit that circumscribes the domain \mathcal{D} :

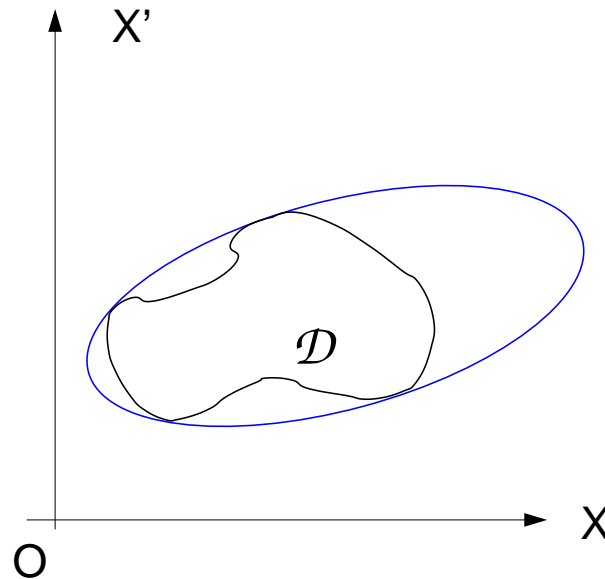

This choice has two major interests :

- an ellipse happens to be a realistic representation of beam extent in phase-space, generally encountered with actual particle beams,
- in a linear transport system, as beam transport optics deals with, an ellipse maps **into another ellipse with identical area.**

This has the two virtues of leaving the generic shape unchanged : an ellipse, and of preserving Liouville's invariance : the area of the ellipse.

Emittance, generalization

At all location along the beam propagation axis, s , each particle in a beam is represented by 6 phase space coordinates,

$$x, x', y, y', \delta s, \delta p/p$$

with

- $x, x' = \frac{dx}{ds}$ horizontal (sometimes called “radial”) position and angle,
- $y, y' = \frac{dy}{ds}$ vertical (sometimes “axial”) position and angle,
- δs difference in path with respect to that of some reference particle,
- $\delta p/p = \frac{p - p_0}{p_0}$ momentum difference relative to some reference momentum, p_0 .

The emittance of the beam is the **6-D volume encompassed by a 6-D hyper-ellipsoid at given isodensity.**

A different choice for the emittance can be, **when the beam has a finite extent**, the volume encompassed by the hyper-ellipsoid that circumscribes that finite beam.

Liouville's theorem establishes that, when transporting a 6-dimensionnal beam along a conservative optical system, the local density within the 6-D phase space volume stays constant.

$$\iiint\iiint\iiint dx dx' dy dy' d\delta s d\delta p/p = \iiint\iiint\iiint dx_0 dx'_0 dy_0 dy'_0 d\delta s_0 d\delta p/p|_0, \quad \frac{D(x, x', y, y', \delta s, \delta p/p)}{D(x_0, x'_0, y_0, y'_0, \delta s_0, \delta p/p|_0)} = 1$$

On the other hand, as we have seen, the three sub-spaces, transverse (x, x') , (y, y') and longitudinal, $(\delta s, \delta p/p)$ are often un-coupled.

Un-coupling has the consequence that Liouville's theorem applies to the projected sub-spaces, namely the emittances in these sub-spaces are preserved :

- the 3-dimensionnal space $x, x', \delta p/p$,
- the 2-dimensionnal projection (x, x') of an ensemble of particles with identical $\delta p/p$ (horizontal phase space),
- and as well the 2-dimensionnal projection (x, x') of an ensemble of particles at a location s where x does not depend on $\delta p/p$ (i.e., if $T_{16} = 0$, or if $\forall s, \frac{1}{\rho} = 0$),
- the 2-dimensionnal projection (y, y') (vertical phase space),
- the 2-dimensionnal projection $(\delta s, \delta p/p)$ (longitudinal phase space).

Some transformations of a propagating phase space ellipse

Drift space

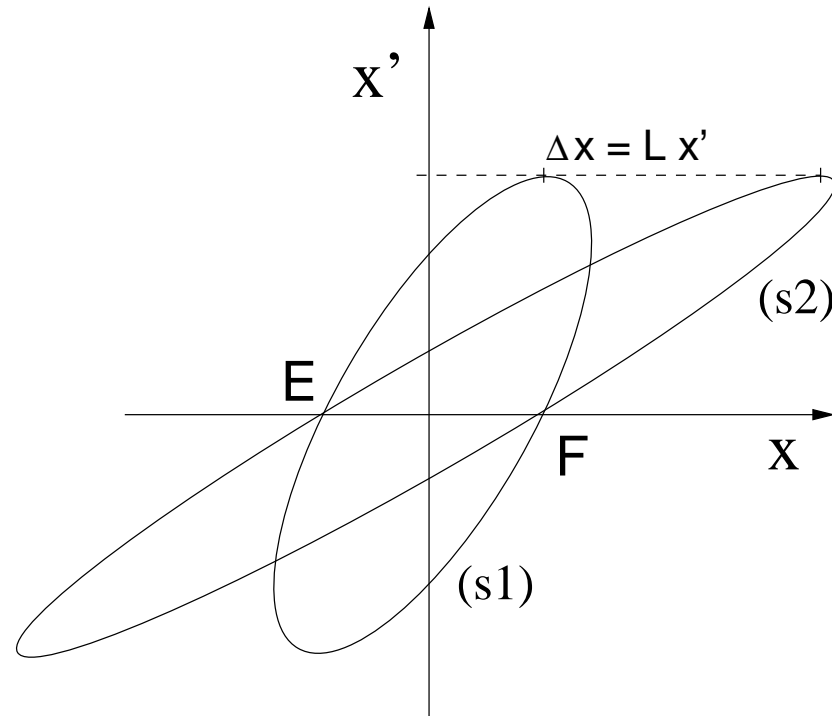

$$M = \begin{bmatrix} 1 & L \\ 0 & 1 \end{bmatrix}, \quad EF \text{ remains unchanged, area remains unchanged.}$$

Thin lens

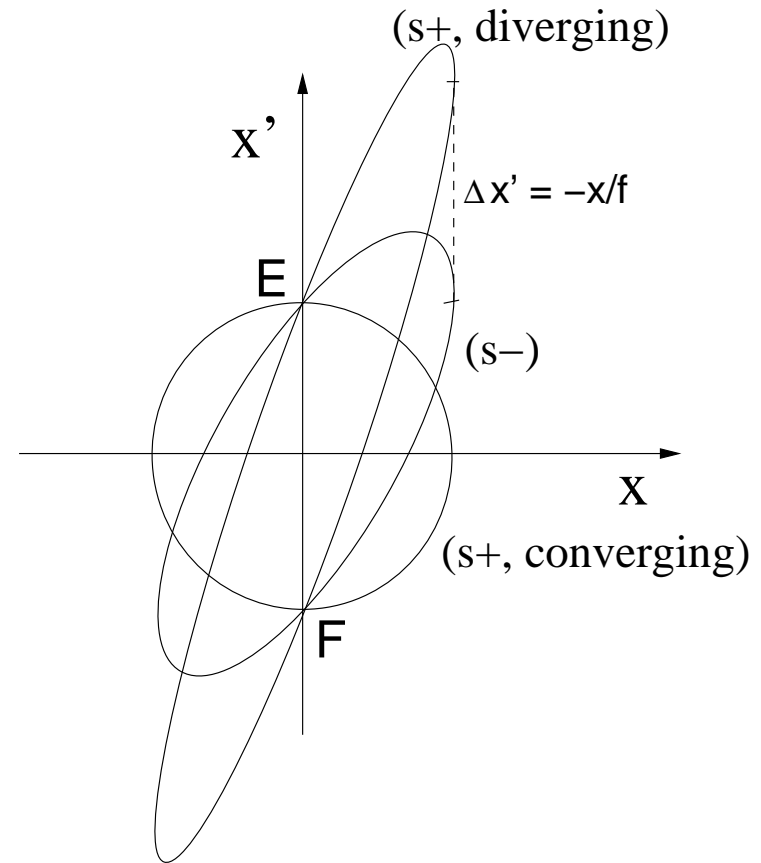
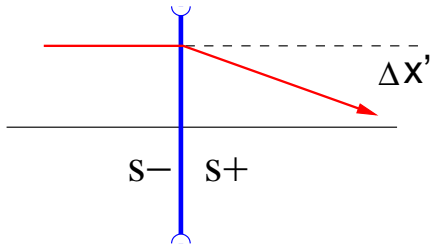
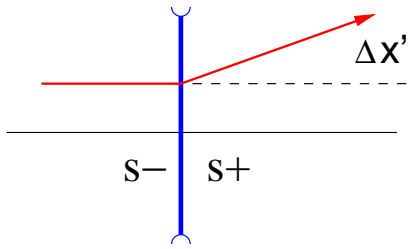

$$M = \begin{bmatrix} 1 & 0 \\ -1/f & 1 \end{bmatrix}, \quad EF \text{ remains unchanged, area remains unchanged.}$$

Thin bending magnet (“kicker”)

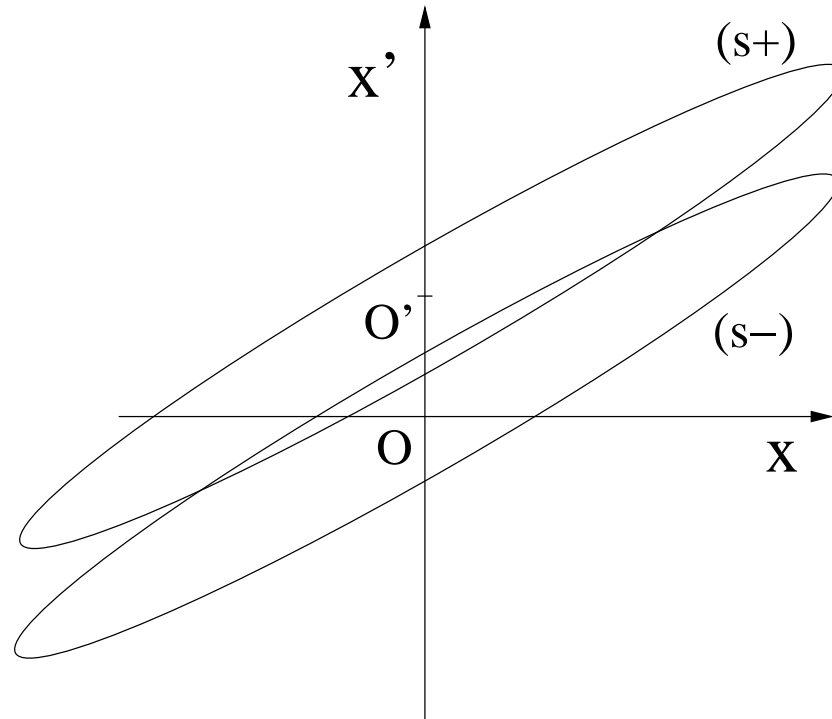

The deviation does not depend on x , the ellipse is unchanged, it is x' -translated.

5.2 The beam matrix, beam transport

Now we are convinced that the ellipse representation of the beam in phase space is relevant, let's proceed with this representation, and with its transport along beam lines.

The general equation of an ellipse can take the form

$$\gamma x^2 + 2\alpha x x' + \beta x'^2 = \frac{\epsilon}{\pi}$$

with ϵ_x the surface of the ellipse.

The coefficients γ , α , β depend on s and are linked by the relation

$$\beta\gamma - \alpha^2 = 1$$

This equation of the ellipse can be written under the form

$$1 = \tilde{X} \sigma^{-1} X$$

with $X = \begin{pmatrix} x \\ x' \end{pmatrix}$, $\tilde{X} = (x, x')$ the transposed vector, and $\sigma^{-1} = \frac{1}{\epsilon/\pi} \begin{bmatrix} \gamma & \alpha \\ \alpha & \beta \end{bmatrix}$

This allows introducing the “**beam matrix**”,

$$\sigma = \frac{\epsilon}{\pi} \begin{bmatrix} \beta & -\alpha \\ -\alpha & \gamma \end{bmatrix} = \begin{bmatrix} \sigma_{11} & \sigma_{12} \\ \sigma_{21} & \sigma_{22} \end{bmatrix}$$

EXERCISE**Prove**

$$1 = \tilde{X}\sigma^{-1}X \Rightarrow \gamma_{\mathbf{x}}^2 + 2\alpha_{\mathbf{x}\mathbf{x}'} + \beta_{\mathbf{x}'^2} = \frac{\epsilon}{\pi}$$

- The beam matrix has the following properties :

At all s ,

- $\det[\sigma] = \left(\frac{\epsilon}{\pi}\right)^2$
- $\sigma_{21} = \sigma_{12}$
- $\sqrt{\sigma_{11}} = x_{max}$
- $\sqrt{\sigma_{22}} = x'_{max}$
- $\frac{\sigma_{12}}{\sqrt{\sigma_{11}}} = x'[x_{max}]$
- $\frac{\sigma_{12}}{\sqrt{\sigma_{22}}} = x[x'_{max}]$
- If $\alpha = 0$,
 $x_{max} \times x'_{max} = \frac{\epsilon}{\pi}$

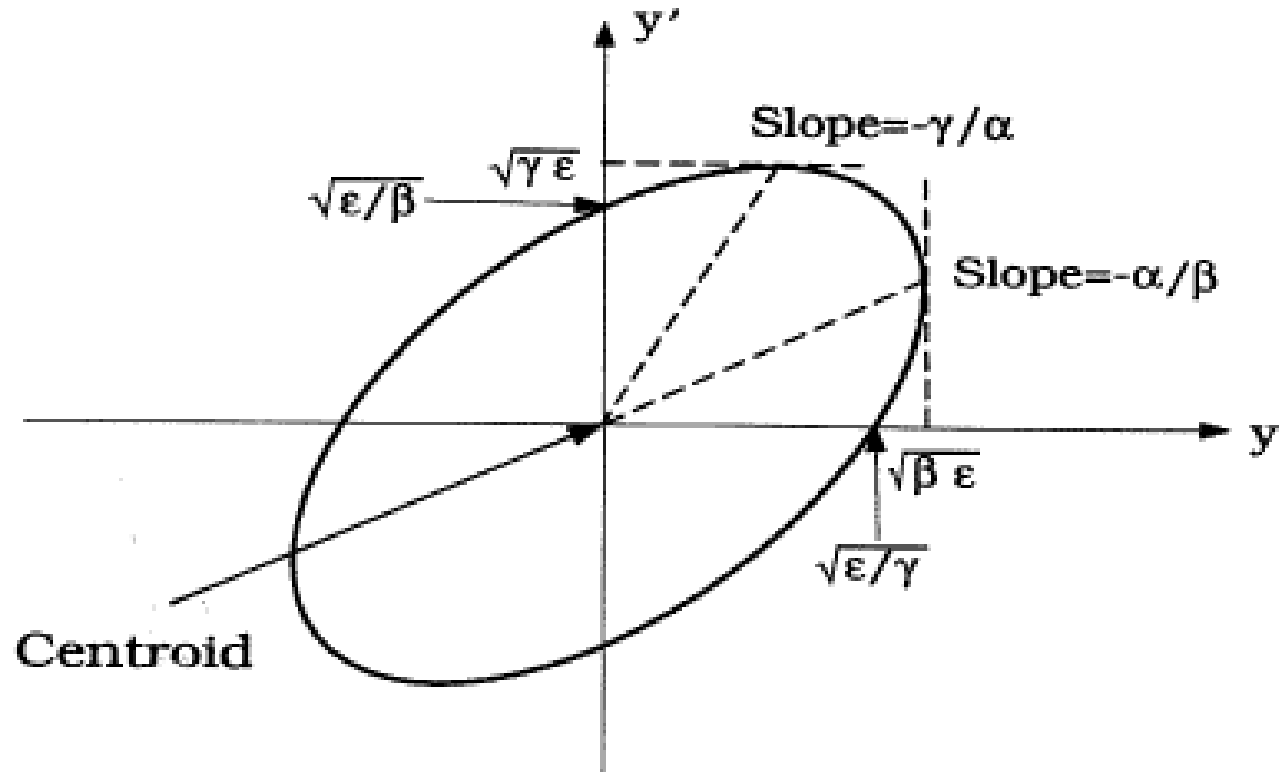

EXERCISE

Prove the relations :

- $\det\sigma = \left(\frac{\epsilon}{\pi}\right)^2$
- $\sqrt{\sigma_{11}} = x_{max}$
- $\sqrt{\sigma_{22}} = x'_{max}$
- $\frac{\sigma_{11}}{\sqrt{\sigma_{11}}} = x'[x_{max}]$
- $\frac{\sigma_{12}}{\sqrt{\sigma_{22}}} = x[x'_{max}]$

Hint : First show that the equation of the ellipse can take the two forms,

$$\frac{\epsilon}{\pi} = \frac{1}{\beta}[\mathbf{x}^2 + (\alpha\mathbf{x} + \beta\mathbf{x}')^2] = \frac{1}{\gamma}[(\gamma\mathbf{x} + \alpha\mathbf{x}')^2 + \mathbf{x}'^2]$$

EXERCISE

Consider a storage ring with $\epsilon_x/\pi = 1.5$ mm.mrad at injection.

The ellipse parameter at injection point into the ring is $\beta_x = 100$ meter.

Estimate the boundaries of beam excursion, in position and in angle, at that location.

Transport of the emittance ellipses

or “Transport of the ellipse parameters”

or “Transport of the beam”

At $s = 0$ the equation of the ellipse writes :

$$\tilde{X}_0 \sigma_0^{-1} X_0 = 1$$

At $s = s_1$ it becomes

$$\tilde{X}_1 \sigma_1^{-1} X_1 = 1$$

with \tilde{X}_1, X_1 being related to \tilde{X}_0, X_0 by

$$X_1 = T X_0 = 1 ; \quad \tilde{X}_1 = T \tilde{X}_0 = \tilde{X}_0 \tilde{T}$$

This yields

$$\tilde{X}_0 \tilde{T} \sigma_0^{-1} T X_0 = 1$$

and by identification with $\tilde{X}_0 \sigma_0^{-1} X_0 = 1$:

$$\sigma_0^{-1} = \tilde{T} \sigma_1^{-1} T \quad \text{thus} \quad \sigma_0 = \tilde{T}^{-1} \sigma_1 (\tilde{T})^{-1}$$

and eventually

$$\sigma_1 = T \sigma_0 \tilde{T}$$

$$\frac{\epsilon}{\pi} \begin{bmatrix} \beta(s_1) & -\alpha(s_1) \\ -\alpha(s_1) & \gamma(s_1) \end{bmatrix} = T(s_1 \leftarrow s_0) \times \frac{\epsilon}{\pi} \begin{bmatrix} \beta(s_0) & -\alpha(s_0) \\ -\alpha(s_0) & \gamma(s_0) \end{bmatrix} \times \tilde{T}(s_1 \leftarrow s_0)$$

From

$$\sigma_1 = T \sigma_0 \tilde{T}$$

we infer that

$$\det[\sigma_1] = \det[\sigma_0] = \left(\frac{\epsilon}{\pi}\right)^2$$

since $\det[T] = 1$,

which is in agreement with the result established earlier :

the beam emittance, $\left(\frac{\epsilon}{\pi}\right)$, is preserved in a conservative system.

Complements

An other way of writing

$$\sigma_1 = T \sigma_0 \tilde{T}$$

is (this can be proved by developing it)

$$\begin{pmatrix} \beta \\ \alpha \\ \gamma \end{pmatrix}_{s_1} = \begin{pmatrix} T_{11}^2 & -2T_{11}T_{12} & T_{12}^2 \\ -T_{11}T_{21} & T_{11}T_{22} + T_{12}T_{21} & -T_{12}T_{22} \\ T_{21}^2 & -2T_{21}T_{22} & T_{22}^2 \end{pmatrix} \begin{pmatrix} \beta \\ \alpha \\ \gamma \end{pmatrix}_{s_0}$$

In particular, this yields the transport of the optical function $\beta(s)$:

$$\beta(s) = T_{11}^2 \beta_0 - 2T_{11}T_{12} \alpha_0 + T_{12}^2 \gamma_0 ,$$

bearing in mind that

$$\boxed{\beta\gamma - \alpha^2 = 1}$$

In addition, by differentiation we obtain

$$\frac{d\beta}{ds} = 2T_{11}T'_{11}\beta_0 - 2(T'_{11}T_{12} + T_{11}T'_{12})\alpha_0 + 2T_{12}T'_{12}\gamma_0 = -2\alpha(s)$$

whereas, results we got earlier : $T'_{11} = T_{21}$, $T'_{12} = T_{22}$, so that, by comparison with the expression for $\alpha(s)$ from the matrix above, we get

$$\boxed{\alpha(s) = -\beta'(s)/2}$$

Transport of the beam envelope

In order to define the envelop of a beam along a transport line, that is to say, determine the region the beam will occupy transversally in optical elements, one calculates at all s along the line the quantity

$$x_{max}(s) = \sqrt{\beta(s) \frac{\epsilon}{\pi}} = \sqrt{\sigma_{11}(s)}$$

starting from initial values of the optical functions at some abscissa s_0 : $\alpha(s_0), \beta(s_0), \gamma(s_0)$

namely,

$$x_{max}(s) = \sqrt{\frac{\epsilon}{\pi} \sqrt{T_{11}^2 \beta_0 - 2T_{11}T_{12} \alpha_0 + T_{12}^2 \gamma_0}}$$

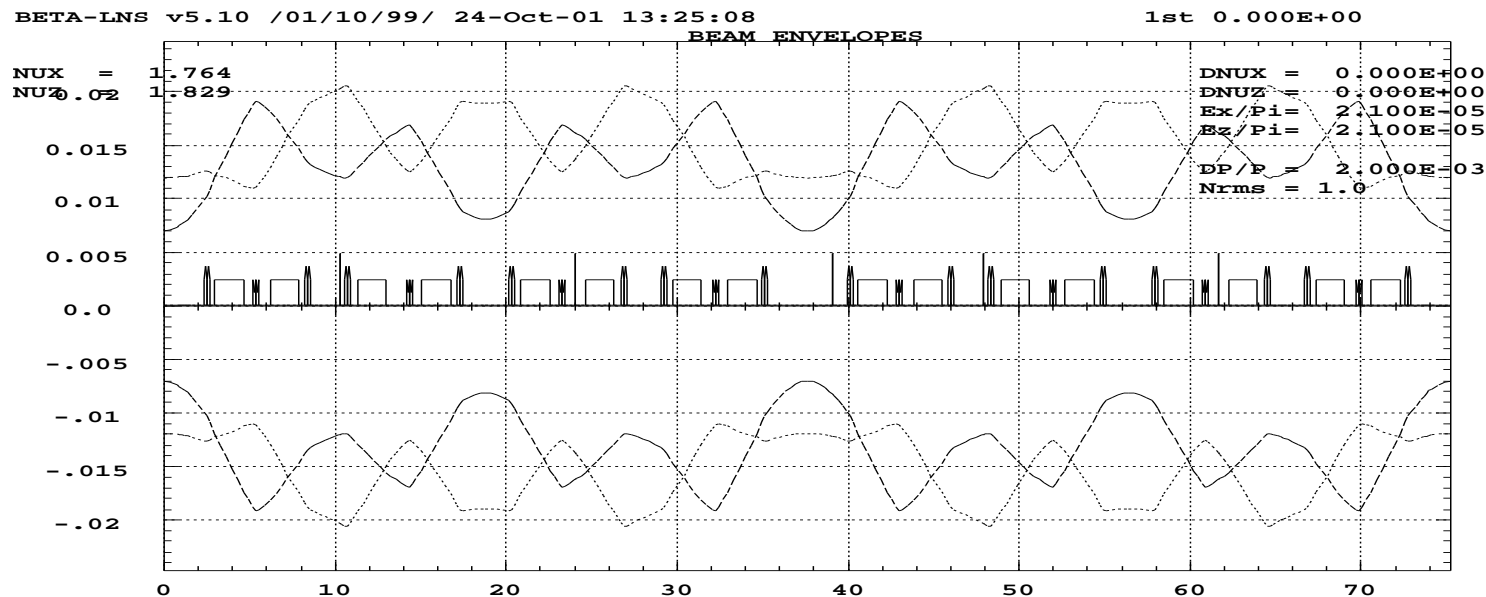

EXERCISE

If a new variable is defined,

$$X' = \alpha x + \beta x'$$

show that the beam in the so-defined phase-space (x, X') is represented by a circle with radius $\sqrt{\beta \epsilon / \pi}$.

6 A tour of optical systems

6.1 Energy loss spectrometer

“Energy loss” spectrometers are optical assemblies that allow determining the energy lost by interaction between a beam and a fixed target,

by measuring the position of the reaction products in the focal plane of the spectrometer :
The position of the reaction products on the focal plane is a measure of their energy and of the energy loss of the reaction.

The Kaon KAOS spectrometer at GSI, Darmstadt, Germany

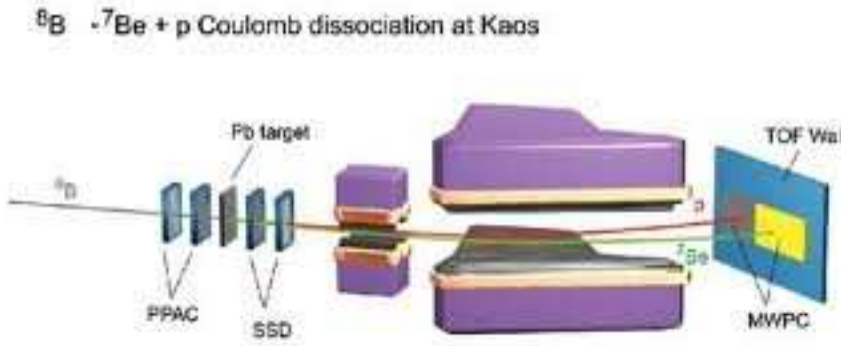

Separation of three different momenta at $\frac{\Delta p}{p} = 0, \pm 30\%$, by the spectrometer dipole :

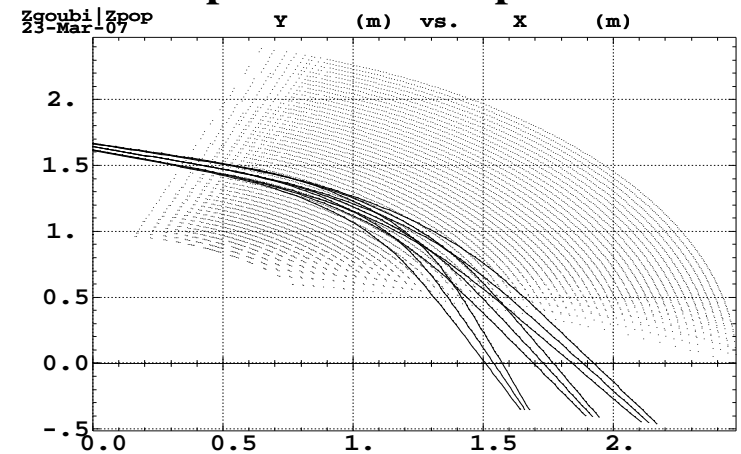

The three momentum families converge to three different, **separated** images, in the focal plane of the spectrometer.

Energy resolution of an optical system

- Two particles with identical initial conditions at the target of the optical assembly, but for **initial momenta differing by Δp** ,

will be separated in the image plane of the optical system

- in position by $\Delta x = T_{16} \Delta p/p$

- in angle by $\Delta x' = T_{26} \Delta p/p$

This stems from

$$\begin{pmatrix} x \\ x' \\ \delta \end{pmatrix} = \begin{pmatrix} T_{11} & T_{12} & T_{16} \\ T_{21} & T_{22} & T_{26} \\ 0 & 0 & 1 \end{pmatrix} \begin{pmatrix} x_0 \\ x'_0 \\ \delta \end{pmatrix}$$

the matrix transport in the dispersive plane of the optical assembly,

- from the object at target
- to the image at the “focal surface” of the system.

- If the optical system constitutes a *focusing system*, then particles issued from the target with impulses ranging in $[p_0 - \Delta p, p_0 + \Delta p,]$ will form a continuum of *monochromatic* images spread along a line which is the trace, in the dispersive plane, of the so-called **focal surface** of the system.

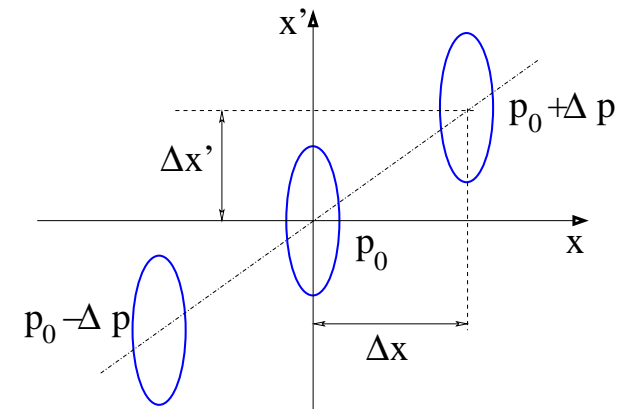
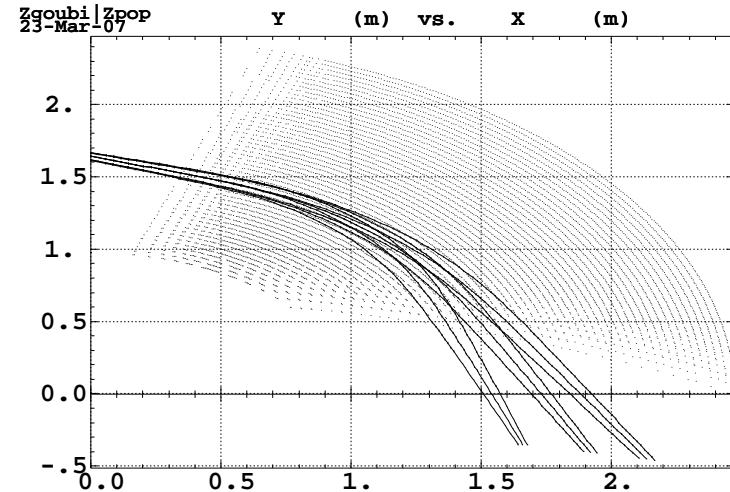

Separation of beam ellipses at the focal surface

Energy resolution of an optical system (cont'd)

The resolution in momentum, \mathcal{R} , is defined by

$$\mathcal{R} = \left. \frac{\delta p}{p} \right|_{\mathcal{R}} = \frac{2\hat{x}}{T_{16}} = \frac{2\sqrt{\beta_x \frac{\epsilon_x}{\pi}}}{T_{16}}$$

i.e., the relative momentum such that the distance

$$\Delta x = T_{16} \Delta p / p_0$$

between the images at p_0 and $p_0 + \Delta p$ respectively is equal to the image size, $2\hat{x}$.

Beam surface in the dipole

An important ingredient in maximizing the resolution \mathcal{R} of a spectrometer is, maximizing the surface of the beam in the dispersive plane inside the spectrometer dipole(s).

This property stems from general theorems regarding beam transport, however a qualitative understanding can be provided by considering phase space properties of the transport through the spectrometer dipole.

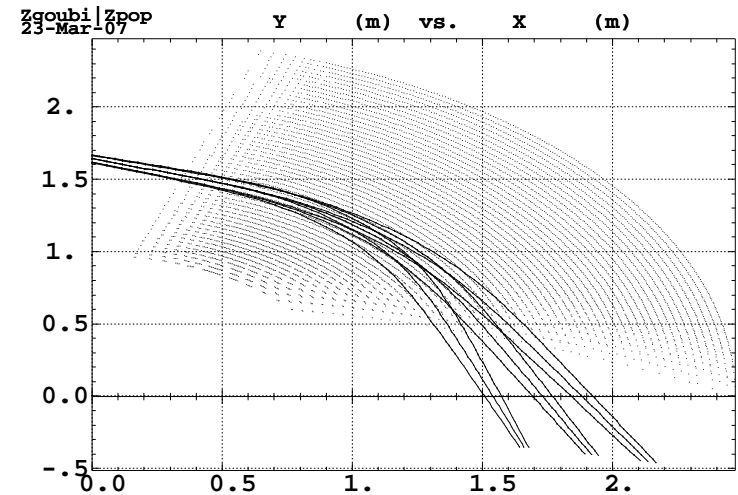
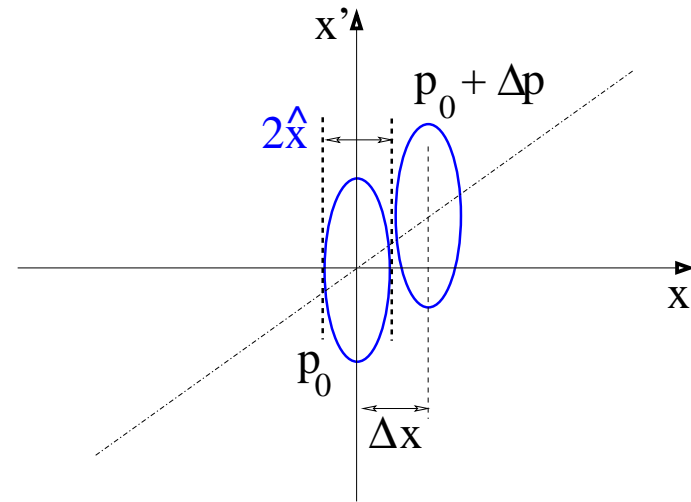

Maximize beam surface in the dipole

For the purpose of simplifying the demonstration a thin-lens approximation of a magnet dipole is considered below, with curvature radius ρ causing a deviation α of the beam for the reference momentum p_0 .

The separation of the p_0 and $p_0 + \Delta p$ ellipses, is given by

$$\Delta x' = T_{26} \Delta p/p \approx \alpha \Delta p/p$$

Remember, pure dipole :

$$\begin{pmatrix} x \\ x' \\ y \\ y' \\ \delta p/p \end{pmatrix} = \begin{pmatrix} \cos \alpha & \rho \sin \alpha & 0 & 0 & \rho(1 - \cos \alpha) \\ -\frac{1}{\rho} \sin \alpha & \cos \alpha & 0 & 0 & \sin \alpha \\ 0 & 0 & 1 & \rho \alpha & 0 \\ 0 & 0 & 0 & 1 & 0 \\ 0 & 0 & 0 & 0 & 1 \end{pmatrix} \begin{pmatrix} x_0 \\ x'_0 \\ y_0 \\ y'_0 \\ \delta p/p \end{pmatrix}$$

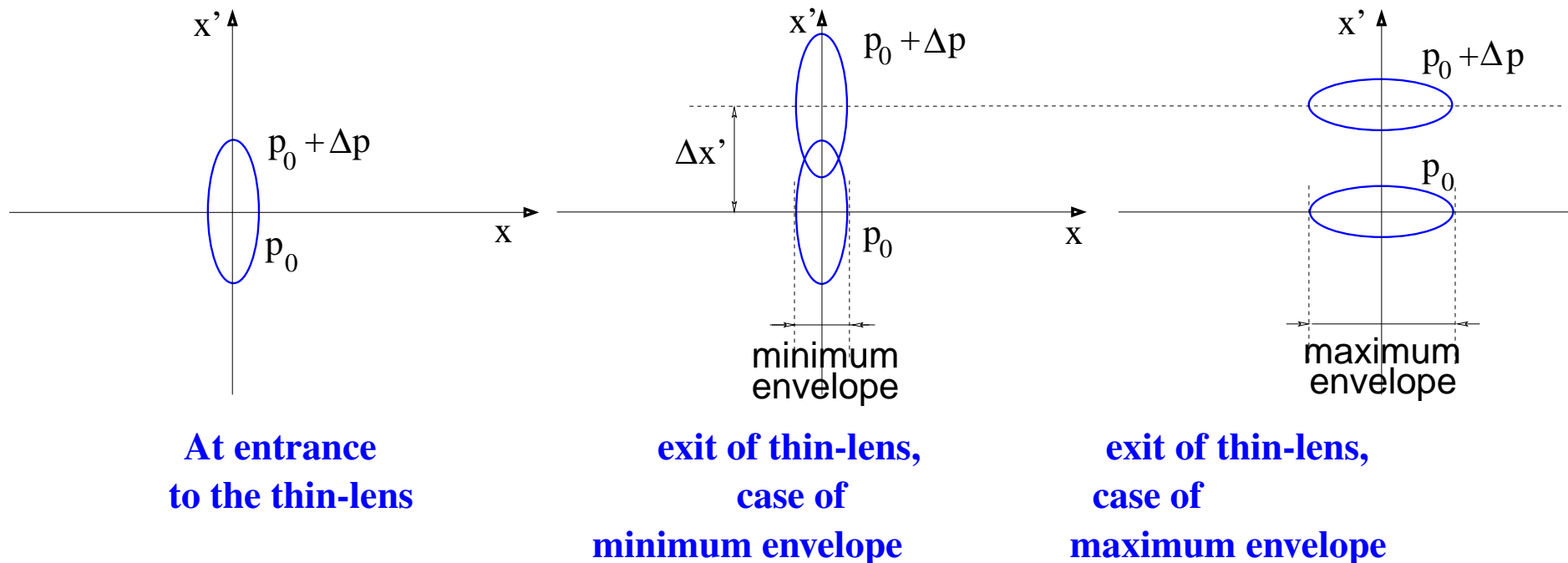

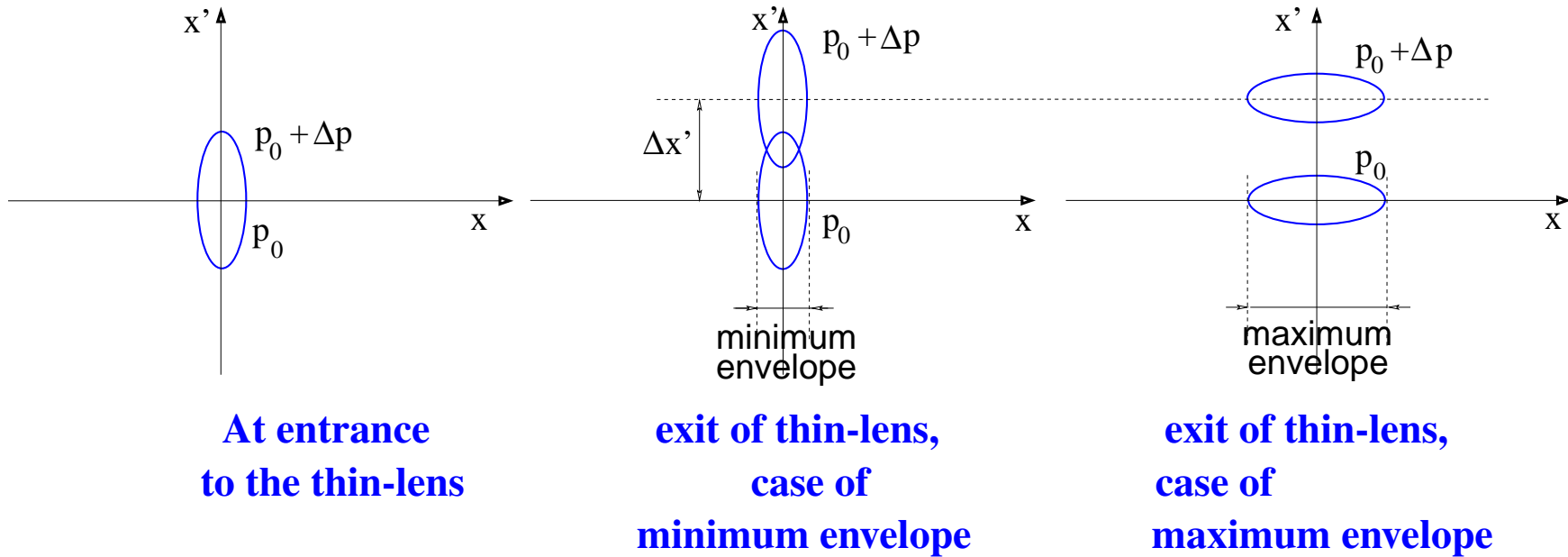

The resolution so acquired will not be changed (i.e., neither lost), whatever the downstream focusing, as long as **no other dipole is encountered**.

At the image in the focal plane, the separation between the Δp image and the $p_0 + \Delta p$ image is

$$\Delta x = T_{16} \frac{\Delta p}{p}$$

and will depend on the focusing down to that location, **however**, the ratio

$$\mathcal{R} = \frac{2 \hat{x}_{Image}}{T_{16}} \text{ is invariant.}$$

Images at the focal plane will be the more separated, the larger the beam is in the dipole.

Analyser

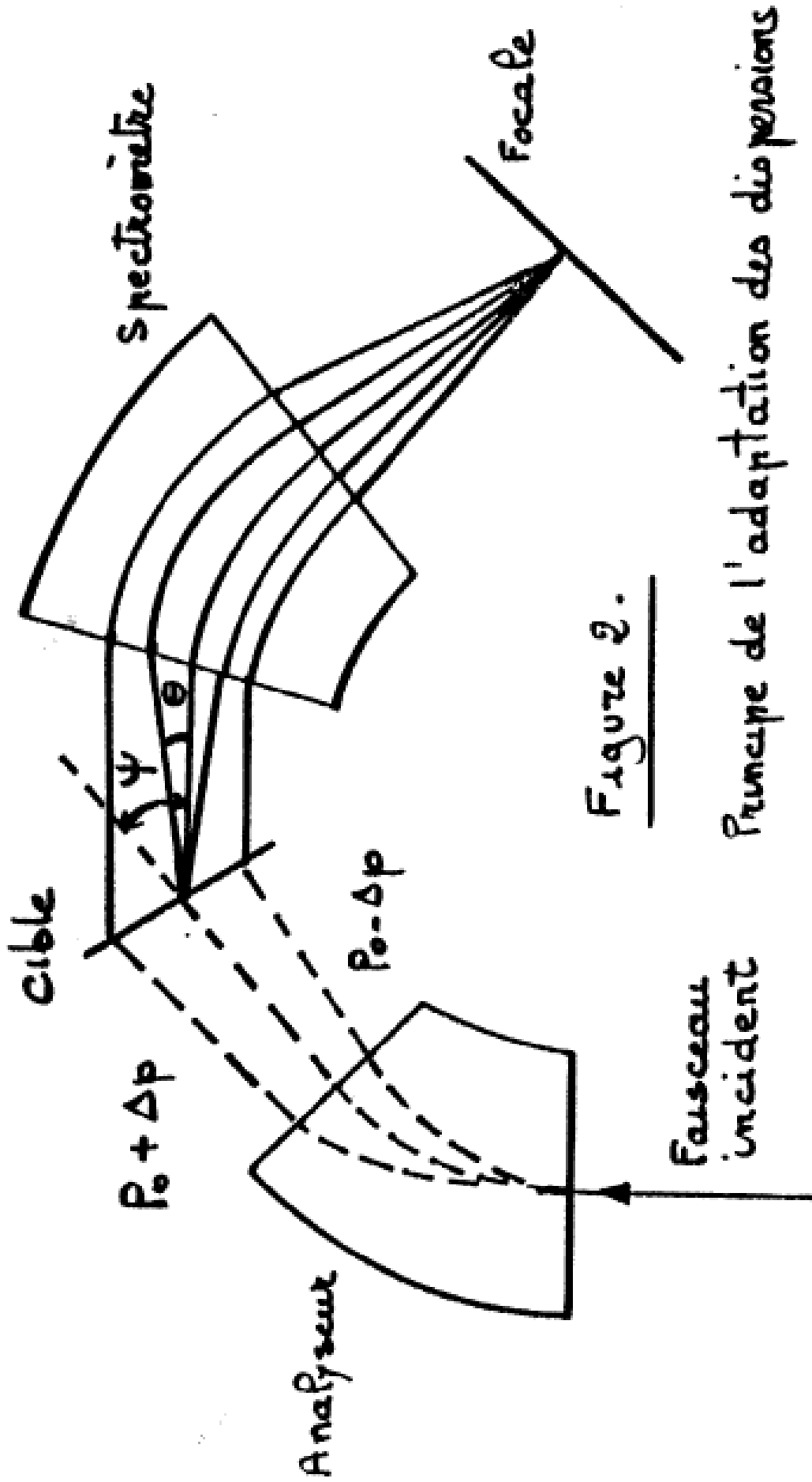

Figure 2.

Principe de l'adaptation des dispersions

The transfer from the target to the focal plane of the spectrometer is given by :

$$\begin{pmatrix} x \\ \theta \\ \delta \end{pmatrix}_{focal} = \begin{pmatrix} S_{11} & S_{12} & S_{16} \\ S_{21} & S_{22} & S_{26} \\ 0 & 0 & 1 \end{pmatrix} \begin{pmatrix} x \\ \theta \\ \delta \end{pmatrix}_{target}$$

with $S_{12} = 0$ by definition at the focal plane.

The transfer from the object O analyzed, and the focal plane of the spectrometer is given by :

$$\begin{pmatrix} x_F \\ \theta_F \\ \delta_F \end{pmatrix} = \begin{pmatrix} S_{11} & 0 & S_{16} \\ S_{21} & S_{22} & S_{26} \\ 0 & 0 & 1 \end{pmatrix} \begin{pmatrix} A_{11} & A_{12} & A_{16} \\ A_{21} & A_{22} & A_{26} \\ 0 & 0 & 1 \end{pmatrix} \begin{pmatrix} x_0 \\ \theta_0 \\ \delta_0 \end{pmatrix} = [T] \begin{pmatrix} x_0 \\ \theta_0 \\ \delta_0 \end{pmatrix}$$

Achromatism in position imposes

$$T_{16} = 0, \quad \text{hence} \quad S_{11}A_{16} + S_{16} = 0$$

S_{16} being given, the analyzer is tuned so to ensure

$$A_{16} = -\frac{S_{16}}{S_{11}} = [S^{-1}]_{16}$$

This relation expresses that the dispersion of the analyzer system must be equal to the inverse dispersion of the spectrometer.

In terms of the resolutions of the spectrometer and of the analyzer, respectively, by definition ;

$$R^{(S)} = \frac{2\hat{x}_{focal}}{S_{16}} \quad \text{and} \quad R^{(A)} = \frac{2\hat{x}_{target}}{A_{16}}$$

and taking into account the following relations :

$$\hat{x}_{focal} = S_{11}\hat{x}_{target} \quad \text{and} \quad A_{16} = -\frac{S_{16}}{S_{11}}$$

it comes

$$\mathbf{R}^{(S)} = \frac{2S_{11}\hat{x}_{target}}{A_{16}} = -\mathbf{R}^{(A)}$$

In other words, the resolution of the analyzer must equal that of the spectrometer for the system Analyzer+Spectrometer to be achromatic in position.

The actual value of $R^{(S)}$ is specified by the users, it is a design specification that depends on the sharpness of the measurements to be realized.

6.2 A high resolution mass separator (HRS)

Mass separators are part of the typical equipments used to handle radioactive beams.

Mass separation leans on the property that trajectories of non-relativistic particles with equal ratio kinetic-energy/charge (i.e., particles that have “seen” the same voltage) are independent of particle mass.

By contrast, particles of identical energy and different masses follow different trajectories in a magnetic field.

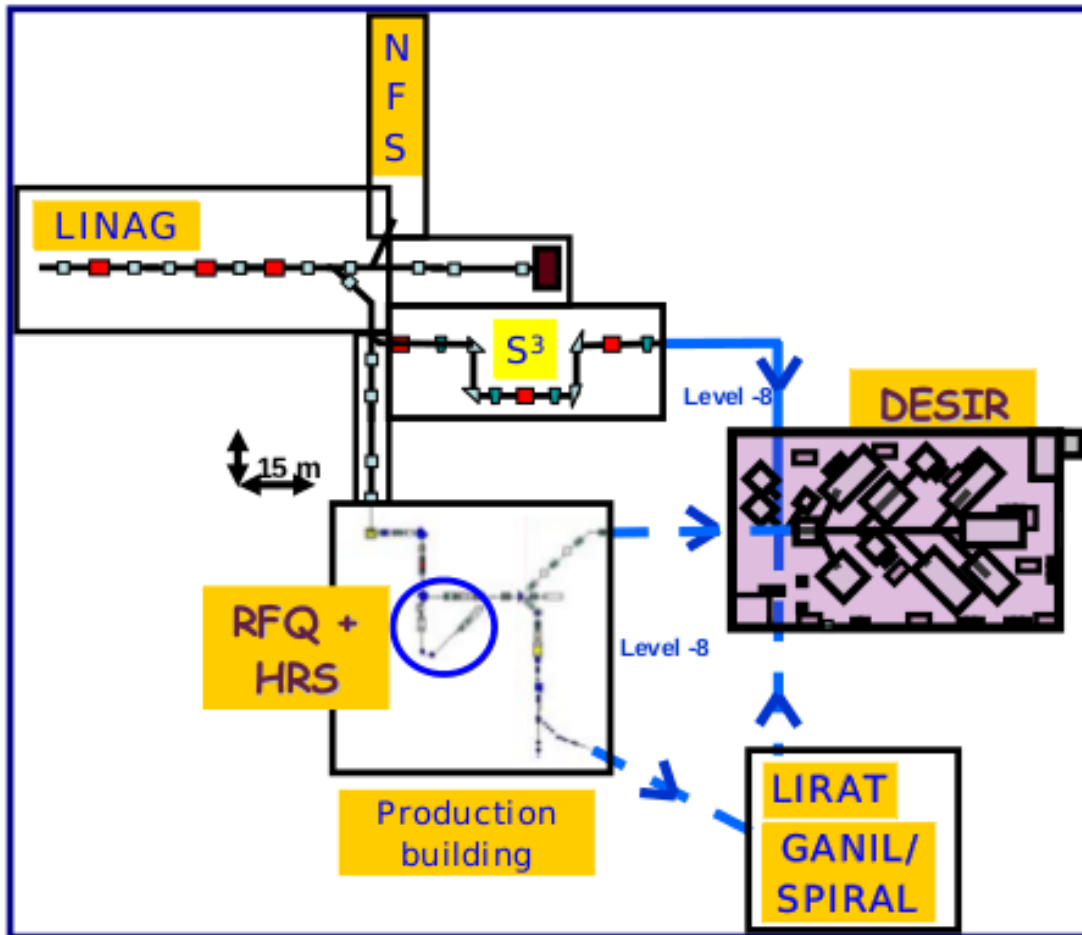

Schematic layout of the DESIR facility in the GANIL, Caen, France.

An RFQ will provide the beam quality needed for the high-resolution separator HRS to achieve its design goal of a resolution of

$$M/\Delta M = 20000$$

Both RFQ and HRS will purify beams from the SPIRAL2 production building. Beams will also arrive from the S3 Super Separator Spectrometer and from SPIRAL1.

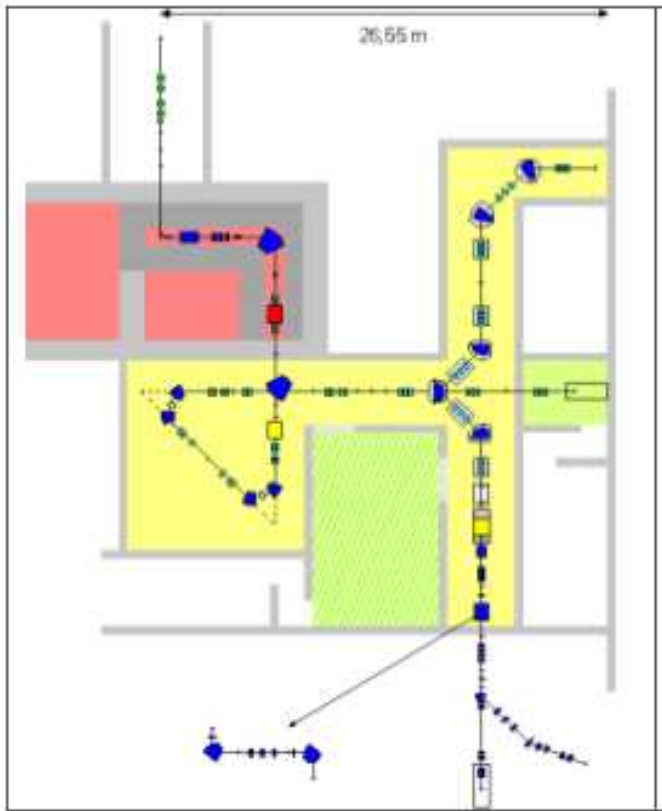

Implementation diagram of the HRS-alpha into the SPIRAL2 production building.

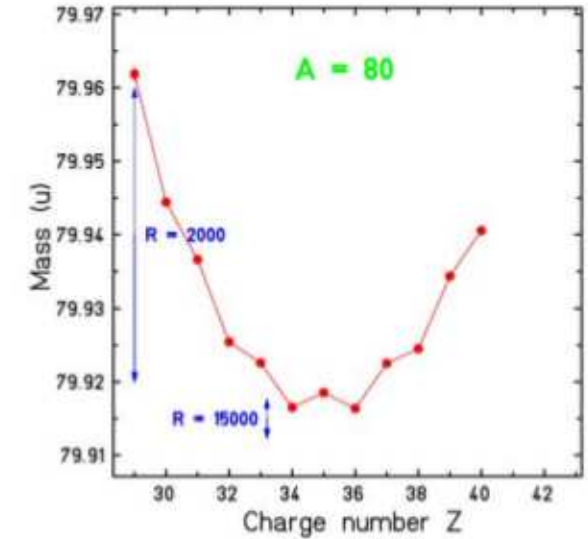
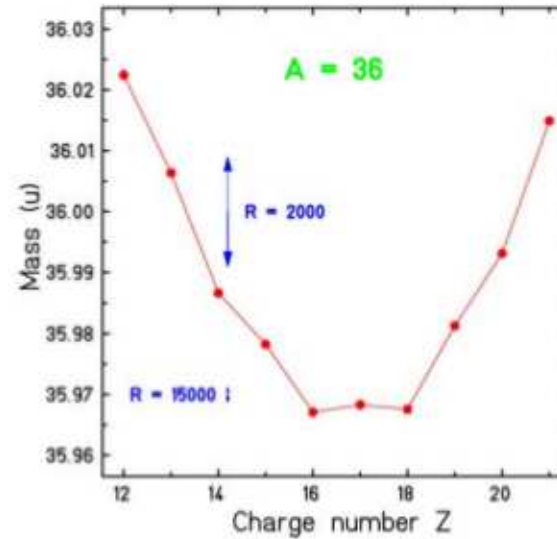

Masses of different nuclei : A=36 (left) and A=80 (right). The arrows indicate the separation power of a separator with a resolution of 2000 and 15000.

For light masses a resolution of the order of 1000-2000 is enough to separate exotic nuclei. However, for the medium-mass nuclei produced by SPIRAL2, a resolution well in excess of 10000 is needed.

Mass spectrometer

Non-relativistic particles that have undergone the same accelerating voltage (they have the same W/q) follow the same trajectory in electrostatic fields, independent of their mass. By contrast with magnetic fields : trajectories of particles with same W/q depend on their mass.

For that reason electric lenses are preferred for focussing heavy particles.

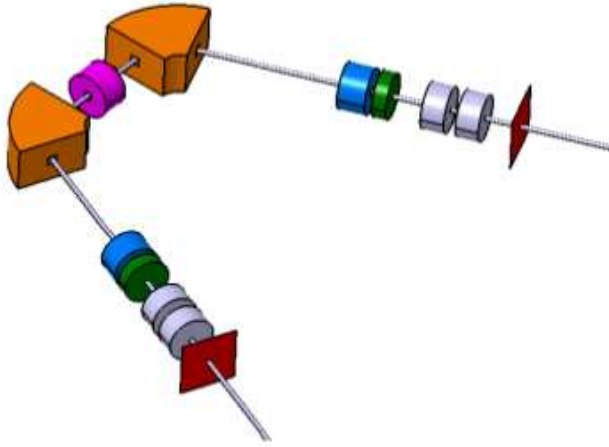

Layout of the HRS-C135. Focusing and corrective elements are all electrostatic and thus settings are independent of mass.

Lattice configuration for HRS-C135

Element	Length (mm)	Element	Length (mm)
Drift length	300	Drift length	360
Matching quadrupole MQ1	200	Dipole D2 $\rho = 50\text{cm}$, $\theta = 67.5^\circ \beta_1 = \beta_2 = 27.5^\circ$ Pole gap=0.04m; width = 0.62m	589
Drift length	100	Drift length D2	1282
Matching quadrupole MQ2	200	Focus quadrupole FQ2	240
Drift length	267	Drift length	60
Focus sextupole FS1	120	Focus sextupole FS2	120
Drift length	60	Drift length	267
Focus quadrupole FQ1	240	Matching quadrupole MQ3	200
Drift length D1	1282	Drift length	100
Dipole D1 $\rho = 50\text{cm}$, $\theta = 67.5^\circ \beta_1 = \beta_2 = 27.5^\circ$ Pole gap=0.04m; width = 0.62m	589	Matching quadrupole MQ4	200
Drift length	360	Drift length	300
Multipole M	240	Slits	

The ion optical design of the HRS-C135 separator consists of two 67.5 degree magnetic dipoles (D) with 27.5 degrees entrance and exit angles, four matching quadrupoles (MQ), two focusing quadrupoles (FQ), two focusing sextupoles (FS) and one multipole (M) with the configuration QQSQDMDQSQQ. Mirror symmetry with respect to the mid-plane minimizes optical aberrations.

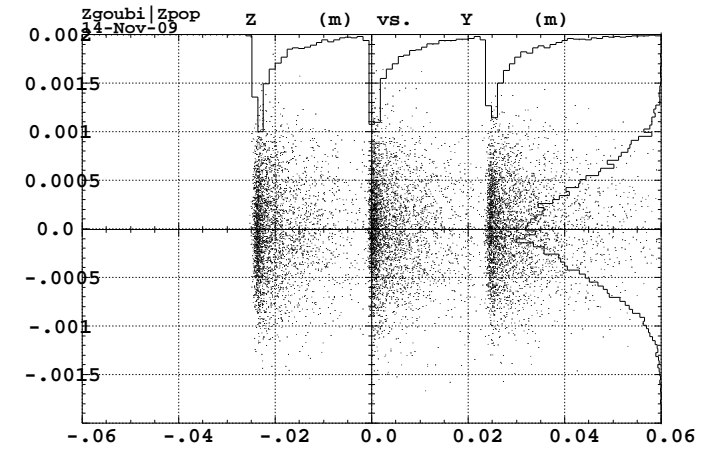

Separation of three momenta
 $\Delta p/p = 0, \pm 0.0005$, at final-focus.
Effect of strong second order aberration (Y/θ^2) is visible.

HRS-C135.

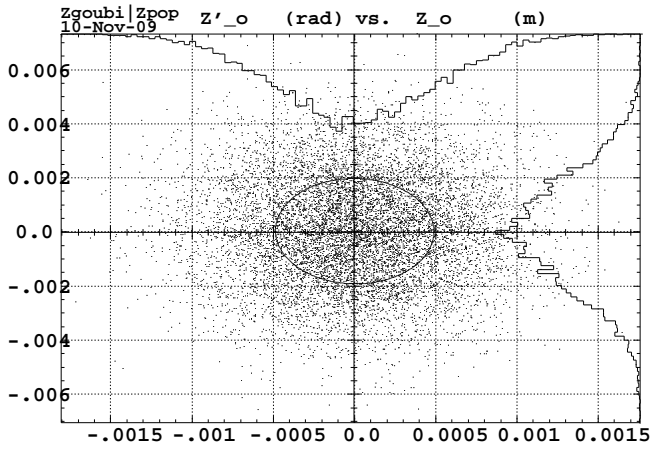
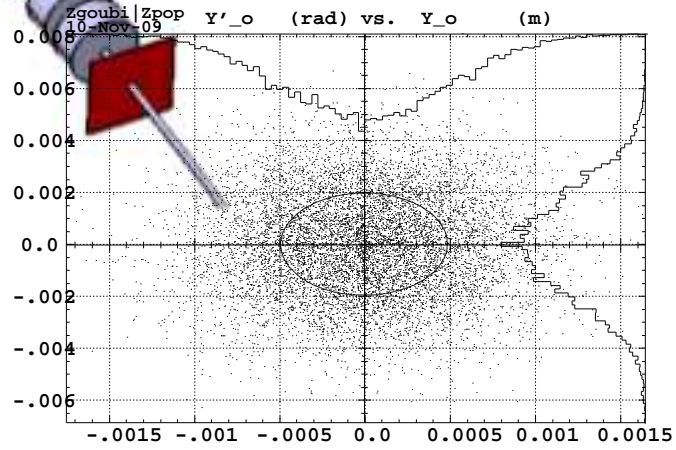

YY' and ZZ' distributions at beginning of HRS-C135.

7 Solutions to the exercises

Solution to EXERCISE page 7

A basic brick of optical systems : “FODO CELL”

Consider the following optical series :

First, a focusing lens with focal distance f ; next, a drift of length l ; next a defocusing lens with the same focal distance f , and finally, another drift of length l .

1/ Calculate the transfer matrix, T .

2/ Verify that the determinant of T is 1.

3/ At what distance A from the system downstream end is its focus ?

4/ At what condition linking f and l is the system globally converging ?

ANSWER

$$1/ T = \begin{pmatrix} 1 & 0 \\ 1/f & 1 \end{pmatrix} \times \begin{pmatrix} 1 & l \\ 0 & 1 \end{pmatrix} \times \begin{pmatrix} 1 & 0 \\ -1/f & 1 \end{pmatrix} = \begin{pmatrix} 1 - \frac{l}{f} & l \\ -\frac{l}{f^2} & 1 + \frac{l}{f} \end{pmatrix}$$

2/ $\det(T) = M_D \times M_l \times M_F$ that all have determinant 1, so has to be the case for

T . Calculation of $T_{11} T_{22} - T_{12} T_{21}$ above does yield determinant = 1.

3/ Consider an additional drift of length A . The transfer matrix of the system is

$$P = \begin{pmatrix} 1 & A \\ 0 & 1 \end{pmatrix} \times \begin{pmatrix} T_{11} & T_{12} \\ T_{21} & T_{22} \end{pmatrix} = \begin{pmatrix} T_{11} + AT_{21} & T_{12} + AT_{22} \\ T_{21} & T_{22} \end{pmatrix}$$

The distance to the focus is obtained from the condition that a ray coming in parallel to the axis ($x'_0 = 0$) will, downstream of the doublet, cross the axis

($x_F = 0$) at the focus,

which writes
$$\begin{pmatrix} 0 \\ x'_F \end{pmatrix} = P \times \begin{pmatrix} x_0 \\ 0 \end{pmatrix}$$

The top row yields $0 = T_{11} + AT_{21}$ i.e., $A = -T_{11}/T_{21} = f^2/l - f$

Focus *downstream*, system is convergent, requires $A > 0$ i.e., $l < f$.

Focus *upstream*, system is divergent, requires $A < 0$ i.e., $l > f$.

Solution to EXERCISE page 9

Going through a first section, (A) , of an optical assembly, the transport writes

$$\begin{pmatrix} x \\ x' \end{pmatrix}_f = \begin{pmatrix} a & b \\ c & d \end{pmatrix} \begin{pmatrix} x \\ x' \end{pmatrix}_i$$

Going through the rest of the assembly, the optical system traversed, (\tilde{A}) , is just the symmetric of (A) .

Express the transport matrix through (\tilde{A}) .

ANSWER

Let us note $\begin{pmatrix} e & f \\ g & h \end{pmatrix}$ the transport matrix through the second section.

Since the optical element assembly is the same, either traversed from left to right for (A) , or from

right to left for (\tilde{A}) , then, the two products $\begin{pmatrix} a & b \\ c & d \end{pmatrix} \times \begin{pmatrix} e & f \\ g & h \end{pmatrix}$ on the one hand, and

$$\times \begin{pmatrix} e & f \\ g & h \end{pmatrix} \begin{pmatrix} a & b \\ c & d \end{pmatrix}$$

have to identify.

Identification of the two matrices coefficient by coefficient yields

(i) $fc = bg$, which is possible if $f = b$ and $g = c$,

$$(ii) \quad eb + fd = fa + hb, \quad ga + hc = ec + gd$$

$eb + fd = fa + hb$ with (i) yields $e + d = a + h$, which is possible if ($e=a$ and $h=d$), trivial, or ($e=d$, $h=a$)

$$\text{Hence, } \begin{pmatrix} e & f \\ g & h \end{pmatrix} = \begin{pmatrix} d & b \\ c & a \end{pmatrix}$$

An alternate method :

Developing

$$\begin{pmatrix} x_1 \\ -x'_1 \end{pmatrix} = \begin{pmatrix} e & f \\ g & h \end{pmatrix} \begin{pmatrix} a & b \\ c & d \end{pmatrix} \begin{pmatrix} x_1 \\ x'_1 \end{pmatrix}$$

yields the system of 4 equations with 4 unknowns

$$\begin{cases} ae + cf = 1 \\ ag + ch = 0 \\ be + df = 0 \\ bg + dh = -1 \end{cases}$$

2/ It can be observed that $R_{11}=R_{22}$, a property that stems from the optical symmetry.

Solution to EXERCISE page 10

We consider the earlier optical series, DLFL, with the two lenses tuned to the same focusing distance $|f|$.

1/ Calculate the transfer matrix of this FODO cell (use earlier exercise, complete with a drift).

Let us introduce a particular notation for T , namely,

$$T_\mu = I \cos \mu, + J \sin \mu$$

with I the identity matrix and $J = \sqrt{-I} = \begin{pmatrix} \alpha & \beta \\ -\gamma & -\alpha \end{pmatrix}$

2/ Make sure $J^2 = -I$

3/ What is the condition linking α, β, γ so that the determinant of T_μ is 1 ?

4/ Considering the trace of T_μ in the latter notation, and by comparison with the trace of T obtained from 1/, what is the condition linking F and D such that the notation

$$T_\mu = I \cos \mu, + J \sin \mu \text{ is valid ?}$$

5/ Show that $(T_\mu)^N = T_\mu(N\mu)$

ANSWER

4/ One has $\frac{1}{2}\text{Trace}(T_\mu) = \cos \mu = 1 - 2 \sin^2 \frac{\mu}{2}$, whereas $\frac{1}{2}\text{Trace}(T) = 1 - \frac{l^2}{2f^2}$

Identification between the two notations requires $\sin^2 \frac{\mu}{2} = \frac{l^2}{4f^2}$,

and thus for T to be writeable under T_μ form the condition that $\frac{l^2}{4f^2} < 1$, i.e., $l < 2f$.

5/ Hint : Recursive demonstration.

6/ 5/ means that $\begin{pmatrix} x \\ x' \end{pmatrix}_N = T_\mu(N\mu) \begin{pmatrix} x \\ x' \end{pmatrix}$ is a bounded quantity, $\|(x, x')_N\|$ is finite, the motion is said to be “stable”, it will remain within bounded limits (the beam “envelope”) forever.

Solution to EXERCISE page 25

$$v_x = \frac{qE_x t c^2}{\sqrt{E_i^2 + (qE_x c t)^2}}$$

Show that $v_x \xrightarrow{t \rightarrow \infty} \pm c$

Solution :

E_i is the initial energy, $E_i = E_0^2 + p_{s0}^2 c^2$ is finite $\left\{ \begin{array}{l} E_0 = m_0 c^2 \text{ is the rest mass, a constant} \\ p_{s0} \text{ is the initial momentum} \end{array} \right.$

As a consequence, $\lim_{t \rightarrow \infty} (E_i^2 + (qE_x c t)^2) = (qE_x c t)^2$

$$\lim_{t \rightarrow \infty} \frac{qE_x t c^2}{\sqrt{E_i^2 + (qE_x c t)^2}} = \frac{qE_x t c^2}{\sqrt{(qE_x c t)^2}} = \frac{qE_x t c^2}{qE_x c t} = c$$

quid erat demonstrandum

Solution to EXERCISE page 28

Show that in the “classical mechanics” case, *id est*, $v \ll c$, the trajectory is a parabola.

Derive the equation of that parabola from the “relativistic mechanics” one,

$$x = \frac{E_i}{qE_x} \left(\cosh \frac{qE_x s}{p_{s0} c} - 1 \right)$$

Solution :

$v = \beta c \ll c$ yields $\sqrt{1 - \beta^2} \approx 1$, $p \equiv m_0 \beta c / \sqrt{1 - \beta^2} \approx m_0 v$
and in particular $p_{s0} \approx m_0 v_0$

On the other hand, the initial energy satisfies

$$E_i^2 = m_0^2 c^4 + p_{s0}^2 c^2 \approx m_0^2 c^4 + m_0^2 v_0^2 c^2 = m_0^2 c^4 (1 + v_0^2/c^2) \approx m_0^2 c^4$$

hence $\vec{E}_i \approx m_0 c^2$

• We need $\frac{qE_x s}{p_{s0} c} \ll 1$! from numerical values.

• Thus, $\cosh() - 1 \approx 1 + ()^2/2 - 1 = ()^2 \propto s^2$, hence the trajectory is a parabola.

• This yields

$$x = \frac{m_0 c^2}{qE_x} \frac{q^2 E_x^2 s^2}{m_0^2 v_0^2 c^2}$$

and, after simplification, the equation of that parabola

$$x = \frac{qE_x s^2}{2m_0 v_0^2}$$

Solution to EXERCISE page 32

A magnet is designed for a proton with velocity $0.2c$ to perform precession at a rate of 10^{-6} second per turn.

What magnetic field value is needed ?

What is the radius of the proton orbit in that field ?

Solution :

$$\begin{aligned}
 B &= m\omega/q \text{ with} \\
 q &= 1.602 \cdot 10^{-19} \text{ C} \\
 E = mc^2 \rightarrow m &= 938.27203 \cdot 10^6 [eV/c^2] \times e/c^2 \text{ g} = \mathbf{1.66803911111e-27 \text{ kg}}, \\
 e &= 1.602 \cdot 10^{-19} \text{ C}, c = 2.99792458 \cdot 10^8 \text{ m/s} \\
 T &= 1 \mu\text{s}, \omega = 2\pi/T \text{ cycle/s} = 6.28 \cdot 10^3 \text{ cycle/sec}
 \end{aligned}$$

$$0.017 \text{ T (Tesla)}, \mathbf{0.17 \text{ kG (kGauss)}, 170 \text{ Gauss}}$$

$$\rho = mv/(qB), v \ll c \Rightarrow E \approx mv^2/2, E = 10^6 \text{ eV}$$

Solution to EXERCISE page 49

Using complex algebra, prove that the transfer matrix of a quadrupole can be written under the form $M_y(s \leftarrow s_0) = \begin{bmatrix} \cos \sqrt{K}L & \frac{1}{\sqrt{K}} \sin \sqrt{K}L \\ -\sqrt{K} \sin \sqrt{K}L & \cos \sqrt{K}L \end{bmatrix}$, whether that quadrupole is focusing or defocusing, indifferently.

ANSWER

Protons are accelerated to 3 GeV kinetic-energy in a ring based on the earlier magnet (curvature radius $\rho = 6.3381$ m, gap height $h = 0.14$ m). The magnet power supply provides 4000 Amperes.

Find the magnetic field value to be achieved in the gap.

Find the number of ampere-turns and the number of turns in the magnets.

ANSWER

We use $p = \sqrt{T(T + 2 \times M)}$, $B\rho = p/q = \sqrt{T(T + 2 \times M)}/c$ (q=charge[e], p=momentum[GeV/c], T=kinetic energy[eV], M=mass[eV/c²]).

- **At 3 GeV, $B\rho = \sqrt{3 \cdot 10^9(3 \cdot 10^9 + 2 \times M)}/c \approx 13$ T.m.
 $B = B\rho/\rho$ yields $B \approx 12/6.3381 \approx 2$ Tesla.**

- **$Bh = \mu_0 NI$ yields $NI \approx 2 \cdot 10^5$ A.T, $N \approx 50$ Turns.**

- **16 such magnets are needed to close the orbit into a ring, i.e. yield 2π deviation.**

Solution to EXERCISE page 76

Consider a dipole with “tapered” gap :

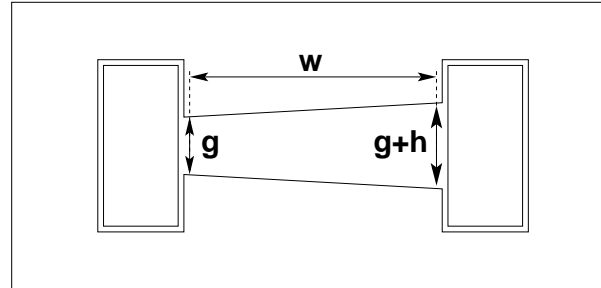

Show that the field index $-\frac{1}{B} \frac{dB}{dx}$ so created takes the value $\frac{h}{gw}$.

ANSWER

To the left of the gap : $\int_C B dl = Bg = \mu_0 NI$, hence $B(g) = B_0 = \frac{\mu_0 NI}{g}$

To the right of the gap : $\int_C B dl = B(g+h) = \mu_0 NI$, hence
 $B(g+h) = \frac{\mu_0 NI}{g+h} = \frac{\mu_0 NI}{g} \left(1 + \frac{h}{g}\right)^{-1} \approx \frac{\mu_0 NI}{g} \left(1 - \frac{h}{g}\right) = B_0 \left(1 - \frac{h}{g}\right)$

Hence $-\frac{dB}{dx} = -\frac{\Delta B}{\Delta x} = -\frac{B(g+h) - B(g)}{w} \approx B_0 \frac{h}{gw}$

Solution to EXERCISE page 85

Given the expression of $V(s,r)$ under the form of a Taylor developement,

$$V = \sum_{i=0}^{\infty} a_{2n}(s)r^{2n} \quad (2)$$

Show that $\frac{1}{r} \frac{\partial}{\partial r} \left(r \frac{\partial V}{\partial r} \right) + \frac{\partial^2 V}{\partial s^2} = \mathbf{0}$ entails $a_{2n}(s) = -\frac{1}{(2n)^2} a''_{2n-2}(s)$

ANSWER

$$\frac{1}{r} \frac{\partial}{\partial r} \left(r \frac{\partial}{\partial r} [a_{2n}(s)r^{2n}] \right) = a_{2n}(s)(2n)^2 r^{2n-2}$$

$$\frac{\partial^2}{\partial s^2} [a_{2n-2}(s)r^{2n-2}] = a''_{2n-2}(s)r^{2n-2}$$

Solution to EXERCISE page 102

Show that $|\vec{v}| = \dot{s}(1 + hx)\vec{s} + \dot{x}\vec{x} + \dot{z}\vec{z}$

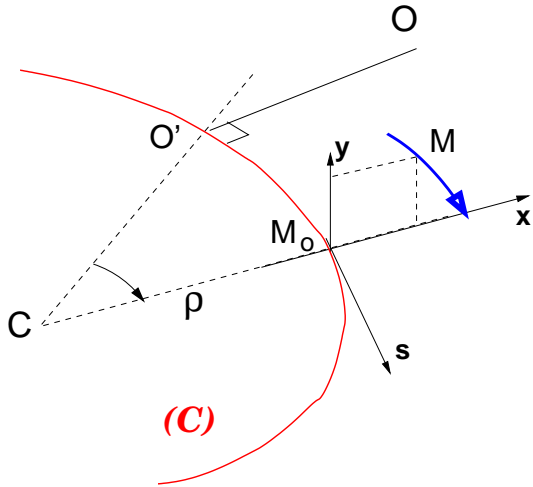

ANSWER

Hyp. : $O\vec{M} = \vec{r} = O\vec{M}_0 + x\vec{x} + y\vec{y}$

By differentiation : $\vec{v} = \dot{\vec{r}} = \frac{dO\vec{M}_0}{dt} + \dot{x}\vec{x} + x\dot{\vec{x}} + y\vec{y}$

Intermediate calculations :

$$(i) \frac{dO\vec{M}_0}{dt} = \frac{d(O\vec{O}' + O'\vec{M}_0)}{dt} = \frac{dO'\vec{M}_0}{dt} = \frac{dO'\vec{M}_0}{ds} \frac{ds}{dt} = \vec{s} \dot{s}$$

$$(ii) \dot{\vec{x}} = \frac{d\vec{x}}{ds} \frac{ds}{dt} = \frac{\vec{s}}{\rho} \frac{ds}{dt} = h\dot{s}\vec{s}$$

Back to \vec{v} :

$$\vec{v} = \dot{\vec{r}} = \dot{s}\vec{s} + \dot{x}\vec{x} + xh\dot{s}\vec{s} + y\vec{y} = \dot{\vec{r}} = \dot{s}(1 + hx)\vec{s} + \dot{x}\vec{x} + y\vec{y}$$

Solution to EXERCISE page 122

Prove the relations :

$$\mathbf{det}[\sigma] = \left(\frac{\epsilon}{\pi}\right)^2, \quad \sqrt{\sigma_{11}} = x_{max}, \quad \sqrt{\sigma_{22}} = x'_{max}, \quad \frac{\sigma_{11}}{\sqrt{\sigma_{11}}} = x'[x_{max}] \quad \frac{\sigma_{12}}{\sqrt{\sigma_{22}}} = x[x'_{max}]$$

ANSWER

Writing the ellipse under the form

$$\frac{\epsilon}{\pi} = \frac{1}{\beta}[\mathbf{x}^2 + (\alpha\mathbf{x} + \beta\mathbf{x}')^2] = \frac{1}{\gamma}[(\gamma\mathbf{x} + \alpha\mathbf{x}')^2 + \mathbf{x}'^2]$$

then, $x = x_{max}$ for $\alpha x + \beta x' = 0$, and $x' = x'_{max}$ for $\gamma x + \alpha x' = 0$

hence the relation above by writing : $\frac{\epsilon}{\pi} = \frac{1}{\beta}x_{max}^2, \quad \frac{\epsilon}{\pi} = \frac{1}{\gamma}x'_{max}^2,$
 $\alpha x_{max} + \beta x'[x_{max}] = 0, \quad \alpha x[x'_{max}] + \alpha x'_{max} = 0.$

We can see that if $\alpha = 0$ ($\sigma_{12} = 0$) one has :

$$\mathbf{det}[\sigma] = \left(\frac{\epsilon}{\pi}\right)^2 \beta\gamma = \sigma_{11}\sigma_{22} = x_{max}^2 \times x'_{max}^2 = \left(\frac{\epsilon}{\pi}\right)^2$$

in that case, the surface of the ellipse, ϵ , satisfies

$$x_{max} \times x'_{max} = \frac{\epsilon}{\pi}$$